

Series 17
Versatile. Robust and bright.

<https://eao.com/>



17 Information about the Series

Key advantages

- Resistant
- Easy to mount
- Versatile
- Long service life
- Metal or plastic body
- Chrome or black finish

Typical application areas

- Mechanical engineering
- Control cabinets
- Measurement technology
- Medical engineering
- And much more

Functions

- Indicator

Design

- Flush
- Raised

IP front protection

- IP40
- IP67

Rating

- No switch rating

Mounting cut-outs

- Ø 6 mm
- Ø 8 mm
- Ø 14 mm
- Ø 16,2 mm
- Ø 22,3 mm

Terminal

- Plug-in terminal

Lens Material

- No lens

Markings

- No marking

Approvals

- UL
- VDE

Conformities

- CE
- 2014/35/EU (LVD) for version 230 VAC
- 2011/65/EU (RoHS)



Raised design	
Indicator 6 mm LED 3 mm	348
Indicator 8 mm LED 5 mm	350
Indicator 14 mm LED 10 mm	354
Indicator 16 mm LED 10 mm	356
Indicator 6 mm LED 3 mm	359
Accessories	361
Technical data	363

01

02

03

04

09

14

17

18

19

22

31

41

45

51

56

57

61

70

71

82

84

92

96

17 Raised design

Indicator 6 mm LED 3 mm, IP40



Product can differ from the current configuration.

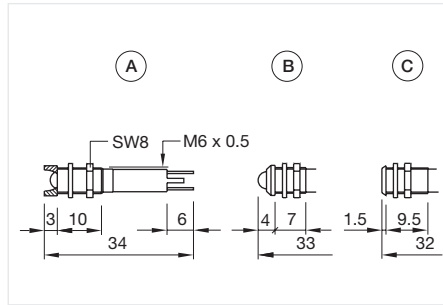

Dimensions [mm]
 A = Interior
 B = Exterior
 C = Superflat

Equipment consisting of (schematic overview)

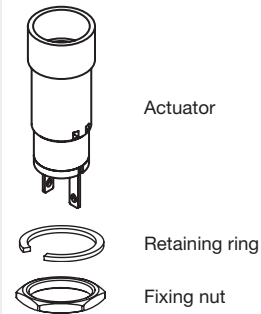

Each Part Number listed below includes all the black components shown in the 3D-drawing.

General information

- Connectors: Brass terminal = anode (+); brass tinned terminal = cathode (-)
- Terminal: Plug-in terminal 2.0 mm x 0.5 mm

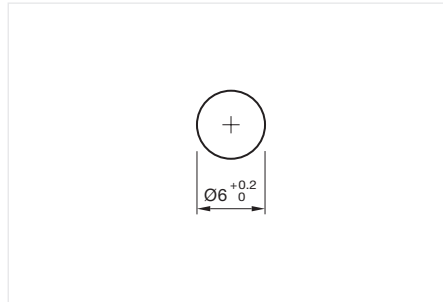

Mounting cut-outs [mm]



Actuator, Front dimension Ø 7 mm

Reflector	Illumination colour	Operating voltage	Operation current	Lumi. Intensity	Part No.	Wiring diagram	Component Layout
Metal, polished chromium-plated, internal	Red	24 V AC/DC ±10 %	15 mA ±15 %	8 mcd	17-030350	70	
	Green	24 V AC/DC ±10 %	15 mA ±15 %	6 mcd	17-030351	70	
	Yellow	24 V AC/DC ±10 %	15 mA ±15 %	6 mcd	17-030352	70	
	Yellow / Green	24 V AC/DC ±10 %	15 mA ±15 %	30/15 mcd	17-030356	70	10
	Blue	24 V AC/DC ±10 %	15 mA ±15 %	26 mcd	17-030357	70	
	White	24 V AC/DC ±10 %	15 mA ±15 %	410 mcd	17-03035W	70	



Actuator, Front dimension Ø 7 mm

Reflector	Illumination colour	Operating voltage	Operation current	Lumi. Intensity	Part No.	Wiring diagram
Metal, polished chromium-plated, domed	Red	24 V AC/DC ±10 %	15 mA ±15 %	8 mcd	17-020350	70
	Green	24 V AC/DC ±10 %	15 mA ±15 %	6 mcd	17-020351	70
	Yellow	24 V AC/DC ±10 %	15 mA ±15 %	6 mcd	17-020352	70
	White	24 V AC/DC ±10 %	15 mA ±15 %	410 mcd	17-02035W	70



Actuator, Front dimension \varnothing 7 mm

Reflector	Illumination colour	Operating voltage	Operation current	Lumi. Intensity	Part No.	Wiring diagram
Metal, polished chromium-plated, flat top LED	Red	24 V AC/DC \pm 10 %	15 mA \pm 15 %	8 mcd	17-000350	70
	Green	24 V AC/DC \pm 10 %	15 mA \pm 15 %	6 mcd	17-000351	70
	Yellow	24 V AC/DC \pm 10 %	15 mA \pm 15 %	6 mcd	17-000352	70

Wiring diagrams

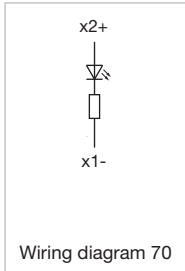

Component layouts

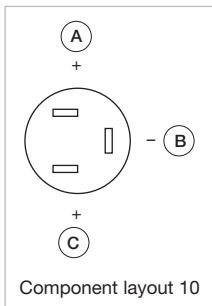

A = Yellow
 B = common cathode
 C = Green

- 01
- 02
- 03
- 04
- 09
- 14
- 17**
- 18
- 19
- 22
- 31
- 41
- 45
- 51
- 56
- 57
- 61
- 70
- 71
- 82
- 84
- 92
- 96

17 Raised design

Indicator 8 mm LED 5 mm, IP67



Product can differ from the current configuration.

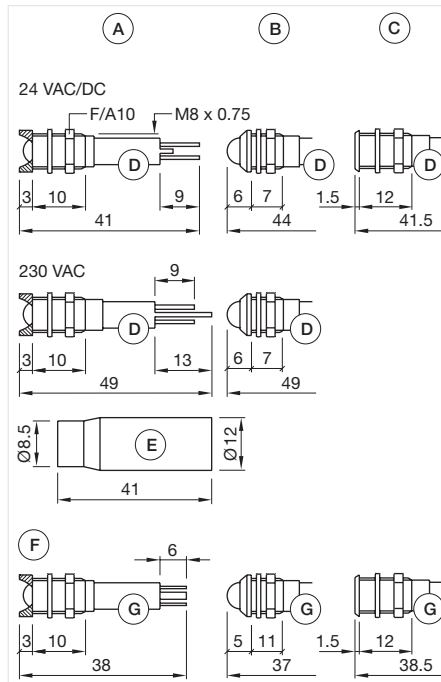

Dimensions [mm]
 A = Interior
 B = Exterior
 C = Superflat
 D = Plug-in terminal 2.8 mm x 0.8 mm
 E = Multi-colour
 F = Protection tube
 G = Plug-in terminal 2.0 mm x 0.5 mm

Equipment consisting of (schematic overview)

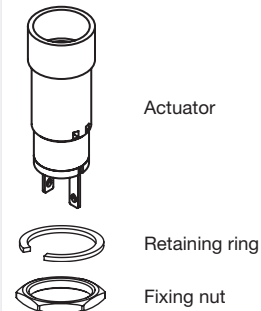

Each Part Number listed below includes all the black components shown in the 3D-drawing.

General information

- Connectors: Brass terminal = anode (+); brass tinned terminal = cathode (-)
- Terminal: Plug-in terminal 2.8 mm x 0.8 mm (Single-LED)
- Terminal: Plug-in terminal 2.0 mm x 0.5 mm (Bi-colour LED)

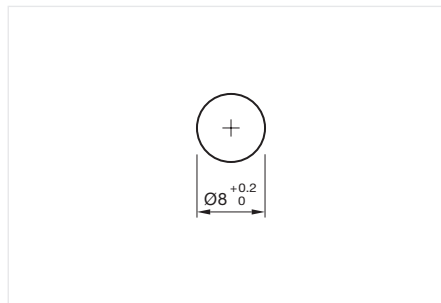

Mounting cut-outs [mm]



Actuator, Front dimension Ø 9,5 mm

Product attributes	Reflector	Illumination colour	Operating voltage	Operation current	Lumi. Intensity	Part No.	Wiring diagram	Component Layout
	Metal, polished chromium-plated, internal	Red	24 V DC ±10 %	20 mA ±15 %	80 mcd	17-050350	70	
	Metal, polished chromium-plated, internal	Red	24 V AC ±10 %	19 mA ±15 %	76 mcd	17-050360	55	
	Metal, polished chromium-plated, internal	Green	24 V DC ±10 %	19 mA ±15 %	32 mcd	17-050351	70	
	Metal, polished chromium-plated, internal	Green	24 V AC ±10 %	20 mA ±15 %	30 mcd	17-050361	55	
	Metal, polished chromium-plated, internal	Yellow	24 V DC ±10 %	20 mA ±15 %	32 mcd	17-050352	70	

Product attributes	Reflector	Illumination colour	Operating voltage	Operation current	Lumi. Intensity	Part No.	Wiring diagram	Component Layout
	Metal, polished chromium-plated, internal	Yellow	24 V AC ±10 %	19 mA ±15 %	30 mcd	17-050362	55	
	Metal, polished chromium-plated, internal	Blue	24 V DC ±10 %	20 mA ±15 %	60 mcd	17-050357	70	
	Metal, polished chromium-plated, internal	Blue	24 V AC ±10 %	20 mA ±15 %	57 mcd	17-050367	55	
	Metal, polished chromium-plated, internal	Red / Green	24 V DC ±10 %	22 mA ±15 %	30/11 mcd	17-130354	128	8
Sunlight visibility, light reduction of around 25 % by use of AC	Metal, polished chromium-plated, internal	Red	24 - 17 V AC/DC ±10 %	9 mA ±15 %	1200 mcd	17-090350	55	
	Metal, polished chromium-plated, internal	Yellow	24 - 17 V AC/DC ±10 %	9 mA ±15 %	1100 mcd	17-090352	55	
	Metal, polished chromium-plated, internal	Green	24 - 17 V AC/DC ±10 %	9 mA ±15 %	1300 mcd	17-090355	55	
	Metal, polished chromium-plated, internal	Blue	24 - 17 V AC/DC ±10 %	9 mA ±15 %	600 mcd	17-090357	55	
	Metal, polished chromium-plated, internal	White	24 - 17 V AC/DC ±10 %	9 mA ±15 %	1000 mcd	17-09035W	55	
With terminals protection tube	Metal, polished chromium-plated, internal	Red	230 V AC ±10 %	3 mA ±15 %	22 mcd	17-500430	55	
	Metal, polished chromium-plated, internal	Green	230 V AC ±10 %	3 mA ±15 %	5 mcd	17-500431	55	
	Metal, polished chromium-plated, internal	Yellow	230 V AC ±10 %	3 mA ±15 %	7 mcd	17-500432	55	
	Metal, black chromium-plated, internal	Red	24 V AC/DC ±10 %	20 mA ±15 %	80 mcd	17-051350	70	
	Metal, black chromium-plated, internal	Green	24 V AC/DC ±10 %	20 mA ±15 %	32 mcd	17-051351	70	
	Metal, black chromium-plated, internal	Yellow	24 V AC/DC ±10 %	20 mA ±15 %	32 mcd	17-051352	70	
	Metal, black chromium-plated, internal	Blue	24 V AC/DC ±10 %	20 mA ±15 %	60 mcd	17-051357	70	



Actuator, Front dimension Ø 9,5 mm

Product attributes	Reflector	Illumination colour	Operating voltage	Operation current	Lumi. Intensity	Part No.	Wiring diagram	Component Layout
	Metal, polished chromium-plated, domed	Red	24 V DC	20 mA ±15 %	80 mcd	17-040350	70	
	Metal, polished chromium-plated, domed	Red	24 V AC	19 mA ±15 %	76 mcd	17-040360	55	
	Metal, polished chromium-plated, domed	Green	24 V DC	20 mA ±15 %	32 mcd	17-040351	70	
	Metal, polished chromium-plated, domed	Green	24 V AC	19 mA ±15 %	30 mcd	17-040361	55	
	Metal, polished chromium-plated, domed	Yellow	24 V DC	20 mA ±15 %	32 mcd	17-040352	70	
	Metal, polished chromium-plated, domed	Yellow	24 V AC	19 mA ±15 %	30 mcd	17-040362	55	
	Metal, polished chromium-plated, domed	Blue	24 V DC	20 mA ±15 %	60 mcd	17-040357	70	
	Metal, polished chromium-plated, domed	Blue	24 V AC	19 mA ±15 %	57 mcd	17-040367	55	
	Metal, polished chromium-plated, domed	Red / Green	24 V DC	22 mA ±15 %	30/11 mcd	17-120354	128	8
	Metal, polished chromium-plated, domed	Red / Yellow	24 V DC	22 mA ±15 %	11/10 mcd	17-120355	128	9
	Metal, polished chromium-plated, domed	Yellow / Green	24 V DC	22 mA ±15 %	20/15 mcd	17-120356	128	10

17 Raised design

Product attributes	Reflector	Illumination colour	Operating voltage	Operation current	Lumi. Intensity	Part No.	Wiring diagram
Sunlight visibility	Metal, polished chromium-plated, domed	Red	24 V AC/DC ± 10 %	9 - 17 mA ± 15 %	1200 mcd	17-080350	55
	Metal, polished chromium-plated, domed	Yellow	24 V AC/DC ± 10 %	9 - 17 mA ± 15 %	1100 mcd	17-080352	55
	Metal, polished chromium-plated, domed	Green	24 V AC/DC ± 10 %	9 - 17 mA ± 15 %	1300 mcd	17-080355	55
	Metal, polished chromium-plated, domed	Blue	24 V AC/DC ± 10 %	9 - 17 mA ± 15 %	600 mcd	17-080357	55
	Metal, polished chromium-plated, domed	White	24 V AC/DC ± 10 %	9 - 17 mA ± 15 %	1000 mcd	17-08035W	55
With terminals protection tube	Metal, polished chromium-plated, domed	Red	230 V AC ± 10 %	3 mA ± 15 %	22 mcd	17-510430	55
	Metal, polished chromium-plated, domed	Green	230 V AC ± 10 %	3 mA ± 15 %	5 mcd	17-510431	55
	Metal, polished chromium-plated, domed	Yellow	230 V AC ± 10 %	3 mA ± 15 %	7 mcd	17-510432	55
	Metal, black chromium-plated, domed	Red	24 V AC ± 10 %	20 mA ± 15 %	80 mcd	17-041350	70
	Metal, black chromium-plated, domed	Green	24 V AC ± 10 %	20 mA ± 15 %	32 mcd	17-041351	70
	Metal, black chromium-plated, domed	Yellow	24 V AC ± 10 %	20 mA ± 15 %	32 mcd	17-041352	70
	Metal, black chromium-plated, domed	Blue	24 V AC ± 10 %	20 mA ± 15 %	60 mcd	17-041357	70



Actuator, Front dimension $\varnothing 9,5$ mm

Reflector	Illumination colour	Operating voltage	Operation current	Lumi. Intensity	Part No.	Wiring diagram	Component Layout
Metal, polished chromium-plated, flat top LED	Red	24 V AC ± 10 %	20 mA ± 15 %	13 mcd	17-010350	70	
	Green	24 V AC ± 10 %	20 mA ± 15 %	8 mcd	17-010351	70	
	Yellow	24 V AC ± 10 %	20 mA ± 15 %	8 mcd	17-010352	70	
	Red / Yellow / Green	24 V AC ± 10 %	15 mA ± 15 %	3/3/6 mcd	17-100354	128	8

Wiring diagrams

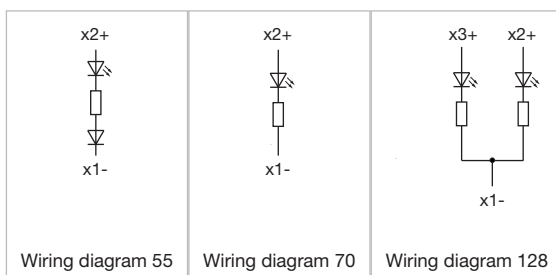

Component layouts

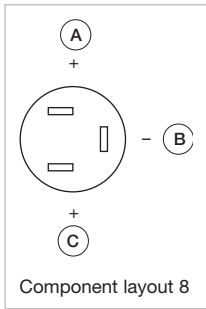

A = Red
B = common cathode
C = Green

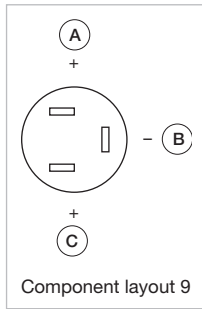

A = Red
B = common cathode
C = Yellow

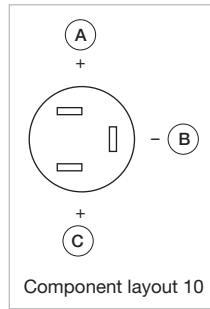

A = Yellow
B = common cathode
C = Green

- 01
- 02
- 03
- 04
- 09
- 14
- 17**
- 18
- 19
- 22
- 31
- 41
- 45
- 51
- 56
- 57
- 61
- 70
- 71
- 82
- 84
- 92
- 96



Follow us.
We are now on YouTube!
EAO ermöglicht. Seit 1947.

[Come take a look at our YouTube profile today!](https://www.youtube.com/user/eaoswitches) Be sure to give us a follow so that you can fully interact with us.

<https://www.youtube.com/user/eaoswitches>

www.eao.com



Your Expert Partner for Human Machine Interfaces

17 Raised design

Indicator 14 mm LED 10 mm, IP67



Product can differ from the current configuration.

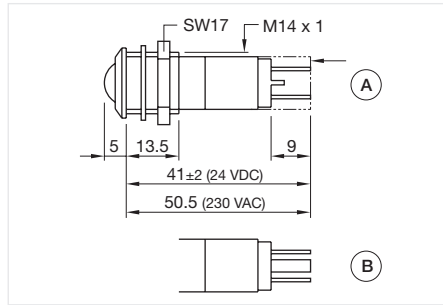

Dimensions [mm]
A = Protection tube (only 230 VAC)
B = Tri-colour

Equipment consisting of (schematic overview)

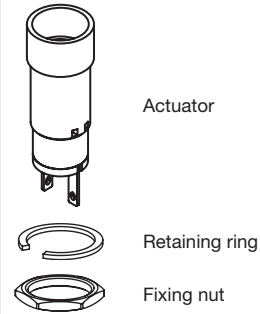

Each Part Number listed below includes all the black components shown in the 3D-drawing.

General information

- Connectors: Brass terminal = anode (+); brass tinned terminal = cathode (-)
- Terminal: Plug-in terminal 2.8 mm x 0.8 mm

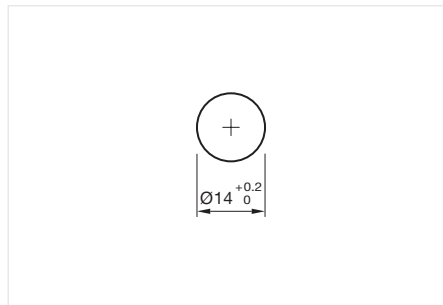

Mounting cut-outs [mm]



Actuator, Front dimension Ø 16 mm

Product attributes	Reflector	Illumination colour	Operating voltage	Operation current	Lumi. Intensity	Part No.	Wiring diagram	Component Layout
	Metal, polished chromium-plated	Red	24 V DC ±10 %	20 mA ±15 %	150 mcd	17-210350	70	
	Metal, polished chromium-plated	Green	24 V DC ±10 %	20 mA ±15 %	70 mcd	17-210351	70	
	Metal, polished chromium-plated	Yellow	24 V DC ±10 %	20 mA ±15 %	70 mcd	17-210352	70	
	Metal, black chromium-plated	Red	24 V DC ±10 %	20 mA ±15 %	150 mcd	17-211350	70	
	Metal, black chromium-plated	Green	24 V DC ±10 %	9 - 17 mA ±15 %	70 mcd	17-211351	70	
	Metal, black chromium-plated	Yellow	24 V DC ±10 %	9 - 17 mA ±15 %	70 mcd	17-211352	70	
Flashing	Metal, polished chromium-plated	Red	24 V DC ±10 %	9 - 17 mA ±15 %	100 mcd	17-220350	129	
	Metal, polished chromium-plated	Green	24 V DC ±10 %	9 - 17 mA ±15 %	70 mcd	17-220351	129	
	Metal, polished chromium-plated	Yellow	24 V DC ±10 %	9 - 17 mA ±15 %	70 mcd	17-220352	129	
	Metal, black chromium-plated	Red	24 V DC ±10 %	9 - 17 mA ±15 %	100 mcd	17-221350	129	
	Metal, black chromium-plated	Green	24 V DC ±10 %	9 - 17 mA ±15 %	70 mcd	17-221351	129	
	Metal, black chromium-plated	Yellow	24 V DC ±10 %	9 - 17 mA ±15 %	70 mcd	17-221352	129	
Tri-colour LED	Metal, polished chromium-plated	Red / Yellow / Green	24 V DC ±10 %	9 - 17 mA ±15 %	90/60/150 mcd	17-240354	128	8
Sunlight visibility	Metal, polished chromium-plated	Red	24 V AC/DC	9 - 17 mA ±15 %	700 mcd	17-2A0350	55	
	Metal, polished chromium-plated	Yellow	24 V AC/DC	9 - 17 mA ±15 %	1000 mcd	17-2A0352	55	
	Metal, polished chromium-plated	Green	24 V AC/DC	9 - 17 mA ±15 %	1250 mcd	17-2A0355	55	
	Metal, polished chromium-plated	Blue	24 V AC/DC	9 - 17 mA ±15 %	500 mcd	17-2A0357	55	

Product attributes	Reflector	Illumination colour	Operating voltage	Operation current	Lumi. Intensity	Part No.	Wiring diagram
Sunlight visibility	Metal, polished chromium-plated	White	24 V AC/DC	9 - 17 mA ±15 %	1350 mcd	17-2A035W	55



Actuator, Front dimension Ø 16 mm

Product attributes	Reflector	Illumination colour	Operating voltage	Operation current	Lumi. Intensity	Part No.	Wiring diagram
With terminals protection tube	Metal, polished chromium-plated	Red	230 V AC	3 mA ±15 %	18 mcd	17-350230	55
	Metal, polished chromium-plated	Green	230 V AC	3 mA ±15 %	11 mcd	17-350231	55
	Metal, polished chromium-plated	Yellow	230 V AC	3 mA ±15 %	8 mcd	17-350233	55
	Metal, black chromium-plated	Red	230 V AC	3 mA ±15 %	18 mcd	17-351230	55
	Metal, black chromium-plated	Green	230 V AC	3 mA ±15 %	11 mcd	17-351231	55
	Metal, black chromium-plated	Yellow	230 V AC	3 mA ±15 %	8 mcd	17-351233	55

Wiring diagrams

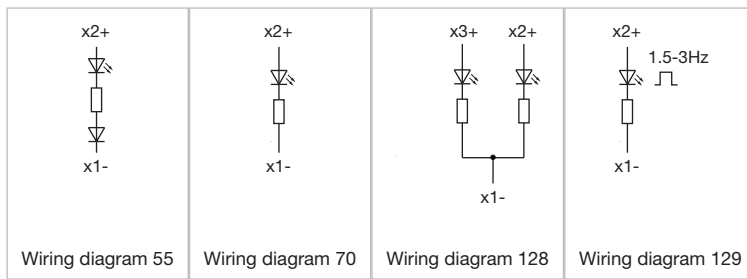

Component layouts

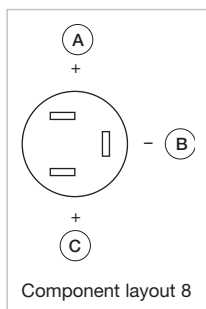

A = Red
B = common cathode
C = Green

17 Raised design

Indicator 16 mm LED 10 mm, IP67



Product can differ from the current configuration.

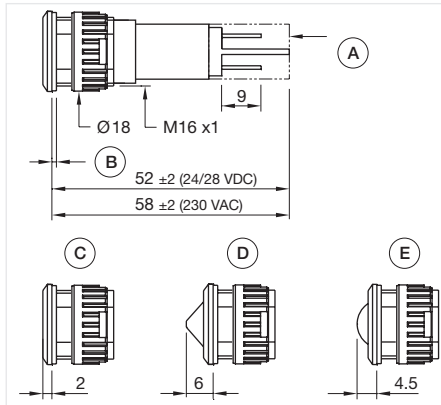

Dimensions [mm]
 A = Protection tube (only 230 VAC)
 B = 1 gasket
 C = Flat
 D = Conical
 E = Round

Equipment consisting of (schematic overview)

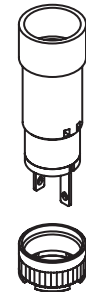

Actuator

Fixing nut

Each Part Number listed below includes all the black components shown in the 3D-drawing.

General information

- Maximum panel thickness 6 mm
- Connectors: Brass terminal = anode (+); brass tinned terminal = cathode (-)
- Terminal: Plug-in terminal 2.8 mm x 0.8 mm

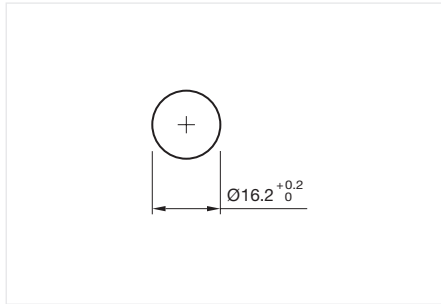

Mounting cut-outs [mm]



Actuator, Front dimension Ø 18,3 mm

Product attributes	Reflector	Illumination colour	Operating voltage	Operation current	Lumi. Intensity	Part No.	Wiring diagram
	Plastic, Black	Red	24 V DC ±10 %	16 mA ±15 %	870 mcd	17-381350Z	70
	Plastic, Black	Green	24 V DC ±10 %	15 mA ±15 %	870 mcd	17-381351Z	70
	Plastic, Black	Yellow	24 V DC ±10 %	16 mA ±15 %	1250 mcd	17-381352Z	70
	Plastic, Black	Ultra green	24 V DC ±10 %	14 mA ±15 %	4130 mcd	17-381355Z	70
	Plastic, Black	Blue	24 V DC ±10 %	14 mA ±15 %	740 mcd	17-381357Z	70
	Plastic, Black	White	24 V DC ±10 %	14 mA ±15 %	1290 mcd	17-38135WZ	70
With terminals protection tube	Plastic, Black	Red	230 V AC ±10 %	3 mA ±15 %	140 mcd	17-411230Z	55
	Plastic, Black	Green	230 V AC ±10 %	3 mA ±15 %	120 mcd	17-411231Z	55
	Plastic, Black	Yellow	230 V AC ±10 %	3 mA ±15 %	130 mcd	17-411232Z	55
	Plastic, Black	Ultra green	230 V AC/DC ±10 %	3 mA ±15 %	970 mcd	17-411235Z	55
	Plastic, Black	Blue	230 V AC ±10 %	3 mA ±15 %	150 mcd	17-411237Z	55
	Plastic, Black	White	230 V AC ±10 %	3 mA ±15 %	280 mcd	17-41123WZ	55



Actuator, Front dimension Ø 18,3 mm

Product attributes	Reflector	Illumination colour	Operating voltage	Operation current	Lumi. Intensity	Part No.	Wiring diagram
	Plastic, Black	Red	24 V DC ±10 %	16 mA ±15 %	1470 mcd	17-391350Z	70
	Plastic, Black	Green	24 V DC ±10 %	16 mA ±15 %	820 mcd	17-391351Z	70
	Plastic, Black	Yellow	24 V DC ±10 %	3 mA ±15 %	1640 mcd	17-391352Z	70
	Plastic, Black	Ultra green	24 V DC ±10 %	3 mA ±15 %	5030 mcd	17-391355Z	70
	Plastic, Black	Blue	24 V DC ±10 %	3 mA ±15 %	860 mcd	17-391357Z	70
	Plastic, Black	White	24 V DC ±10 %	3 mA ±15 %	2760 mcd	17-39135WZ	70
With terminals protection tube	Plastic, Black	Red	230 V AC ±10 %	3 mA ±15 %	240 mcd	17-421230Z	55
	Plastic, Black	Green	230 V AC ±10 %	3 mA ±15 %	120 mcd	17-421231Z	55
	Plastic, Black	Yellow	230 V AC ±10 %	3 mA ±15 %	190 mcd	17-421232Z	55
	Plastic, Black	Ultra green	230 V AC ±10 %	3 mA ±15 %	1280 mcd	17-421235Z	55
	Plastic, Black	Blue	230 V AC ±10 %	3 mA ±15 %	200 mcd	17-421237Z	55
	Plastic, Black	White	230 V AC ±10 %	3 mA ±15 %	500 mcd	17-42123WZ	55



Actuator, Front dimension Ø 18,3 mm

Product attributes	Reflector	Illumination colour	Operating voltage	Operation current	Lumi. Intensity	Part No.	Wiring diagram
	Plastic, Black	Red	24 V DC ±10 %	16 mA ±15 %	1200 mcd	17-371350Z	70
	Plastic, Black	Green	24 V DC ±10 %	15 mA ±15 %	980 mcd	17-371351Z	70
	Plastic, Black	Yellow	24 V DC ±10 %	16 mA ±15 %	1650 mcd	17-371352Z	70
	Plastic, Black	Ultra green	24 V DC ±10 %	14 mA ±15 %	5440 mcd	17-371355Z	70
	Plastic, Black	White	24 V DC ±10 %	14 mA ±15 %	2460 mcd	17-37135WZ	70
With terminals protection tube	Plastic, Black	Red	230 V AC ±10 %	3 mA ±15 %	240 mcd	17-401230Z	55
	Plastic, Black	Green	230 V AC ±10 %	3 mA ±15 %	150 mcd	17-401231Z	55
	Plastic, Black	Yellow	230 V AC ±10 %	3 mA ±15 %	210 mcd	17-401232Z	55
	Plastic, Black	Ultra green	230 V AC ±10 %	3 mA ±15 %	1560 mcd	17-401235Z	55
	Plastic, Black	Blue	230 V AC ±10 %	3 mA ±15 %	200 mcd	17-401237Z	55
	Plastic, Black	White	230 V AC ±10 %	3 mA ±15 %	350 mcd	17-40123WZ	55

Wiring diagrams

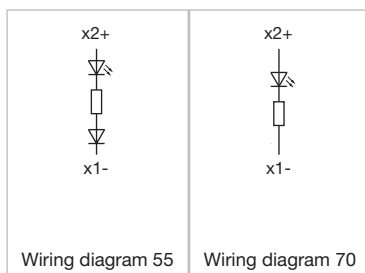

- 01
- 02
- 03
- 04
- 09
- 14
- 17
- 18
- 19
- 22
- 31
- 41
- 45
- 51
- 56
- 57
- 61
- 70
- 71
- 82
- 84
- 92
- 96



Follow us.
We are on LinkedIn!
EAO creates possibilities. Since 1947.



 [Come take a look at our LinkedIn profile today!](https://www.linkedin.com/company/eao/) Be sure to give us a follow so that you can fully interact with us.

<https://www.linkedin.com/company/eao/>

www.eao.com

eao ■
Your Expert Partner for Human Machine Interfaces

Indicator 6 mm LED 3 mm, IP67

Equipment consisting of (schematic overview)

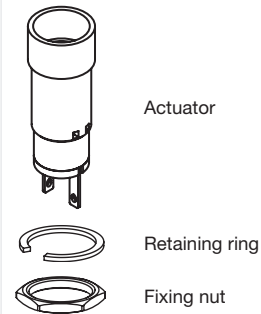

Each Part Number listed below includes all the black components shown in the 3D-drawing.

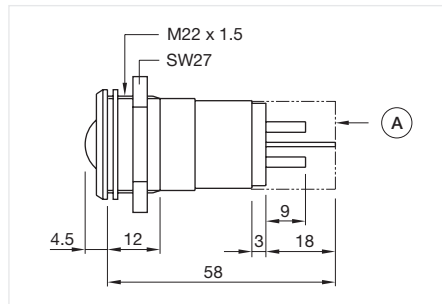

Dimensions [mm]
A = Protection tube



Product can differ from the current configuration.

General information

- Maximum panel thickness 6 mm
- Connectors: Brass terminal = anode (+); brass tinned terminal = cathode (-)
- Terminal: Plug-in terminal 2.8 mm x 0.8 mm

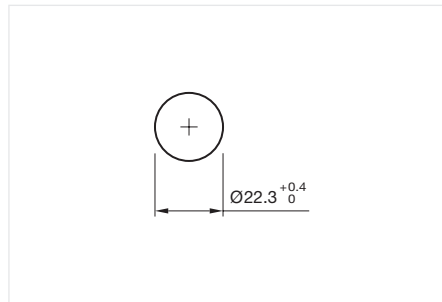

Mounting cut-outs [mm]



Actuator, Front dimension Ø 25 mm

Reflector	Illumination colour	Operating voltage	Operation current	Lumi. Intensity	Part No.	Wiring diagram	Component Layout
Metal, polished chromium-plated	Red	24 V DC ±10 %	19 mA ±15 %	160 mcd	17-530350	70	11
	Green	24 V DC ±10 %	19 mA ±15 %	120 mcd	17-530351	70	11
	Yellow	24 V DC ±10 %	19 mA ±15 %	350 mcd	17-530352	70	11
	Red / Yellow / Green	24 V DC ±10 %	24 - 50 mA ±15 %	51/92/120 mcd	17-540354	128	12



Actuator, Front dimension Ø 25 mm

Product attributes	Reflector	Illumination colour	Operating voltage	Operation current	Lumi. Intensity	Part No.	Wiring diagram	Component Layout
With terminals protection tube	Metal, polished chromium-plated	Green	230 V AC ±10 %	4 mA ±15 %	20 mcd	17-570231	55	11
	Metal, polished chromium-plated	Yellow	230 V AC ±10 %	4 mA ±15 %	48 mcd	17-570232	55	11

Wiring diagrams

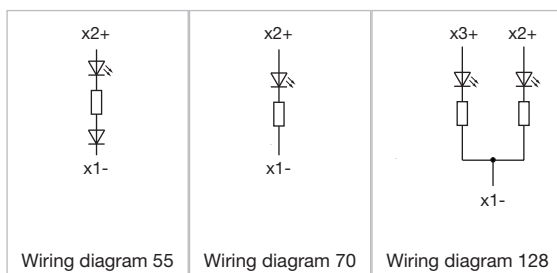

17 Raised design

Component layouts

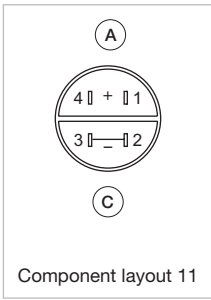

A = Anode
B = Cathode

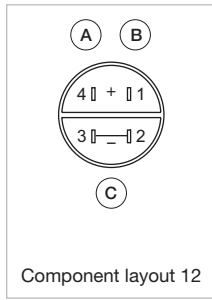

A = Green
B = Red
C = common cathode

Rear side



Insulation sleeve

Product attributes	Material	Part No.
2.0 x 0.5 mm plug-in terminal	metal	31-945
2.8 x 0.8 mm plug-in terminal	metal	84-9420



Terminal cover

Product attributes	Material	Part No.
For flat receptacle 2.0 mm	plastic	31-928
For flat receptacle 2.8 mm	plastic	31-929

- 01
- 02
- 03
- 04
- 09
- 14
- 17**
- 18
- 19
- 22
- 31
- 41
- 45
- 51
- 56
- 57
- 61
- 70
- 71
- 82
- 84
- 92
- 96



Follow us.
We are now on YouTube!
EAO ermöglicht. Seit 1947.



Come take a look at our YouTube profile today! *Be sure to give us a follow so that you can fully interact with us.*

<https://www.youtube.com/user/eaoswitches>

www.eao.com



Your Expert Partner for Human Machine Interfaces

17 Accessories

Mounting



Fixing nut

Dimensions	Material	Thread	Part No.
Ø 9 mm	metal	M8 x 13 mm	19-991



Mounting tool

Product attributes	Dimensions	Material	Part No.
For tightening or loosening of the fixing nut Ø 16 mm	Ø 16 mm	metal	01-907
For fixing nut long Part No. 19-991		metal	19-905

Indicator

Material

Actuator

Reflector Brass high-gloss chrome-plated or black chrome-plated
 Ø 16mm indicator. Additional reflectors made of black plastic. The plastic is limited resistant to chemicals.

Mechanical characteristics

Terminals

Plug-in terminal 2.0 mm x 0.5 mm oder 2.8mm x 0.8 mm.
 The indicators with tab-connection are not qualified for soldering.

Tightening torque

0.2Ncm

Electrical characteristics

Polarity

Anode (+) Brass plug-in connector
 Cathode (-) Brass tinned plug-in connector

Optical characteristics

Wave length

Red	660 nm
Super red	625 nm
Hyper red	660 nm
Orange	625 nm (operated at 230V: 610 nm)
Green	565 nm
Yellow/Green	570 nm (operated at 230V: 575 nm)
Yellow	590 nm
Blue	475 nm
Red/Green	660/565 nm
Red/Yellow	660/590 nm

Ambient conditions

Storage temperature

-25 °C ... +80 °C

Service temperature

-20 °C ... +60 °C

Protection degree

IP40 front side
 IP67 as per DIN EN 60529 - Gap between LED and reflector and gap between reflector and frontplate sealed to IP67 when using the supplied gasket.

Approvals

Approbations

UL

Conformities

2014/35/EC (230VAC)
 2011/65/EC (RoHS)

EAO reserves the right to alter specifications without further notice.

