

# Targus®

## USB-C UNIVERSAL DUAL VIDEO 4K DOCKING STATION WITH 100W POWER



### QUICK START GUIDE

410-3723-001A / DOCK190USZ

#### Contents

- Targus USB-C Universal Dual Video 4K Docking Station with 100W Power
- USB-C Cable
- AC Power adapter
- USB-C to USB-A adapter with Tether
- DC Output Cable
- Power Tips - 3A, 3H, 3H2, 3I2, 3P, 3W, 3X9
- USB-C mount bracket (for selected models)



Features and specifications are subject to change without notice. Microsoft and Windows are registered trademarks of Microsoft Corporation in the United States and/or other countries. All trademarks and registered trademarks are the property of their respective owners. ©2018 Targus, 1211 North Miller Street, Anaheim, CA 92806

#### Workstation Setup

1. Connect all peripheral devices to the docking station

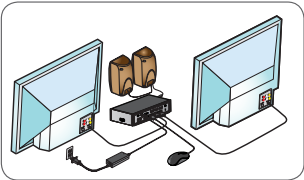

2. Connect the Targus Universal Docking Station to your host device.

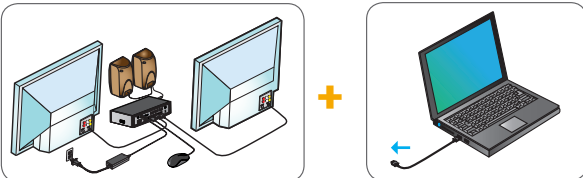

3. If your host device does not connect via USB-C, use the included USB-C to USB-A adapter as shown below.

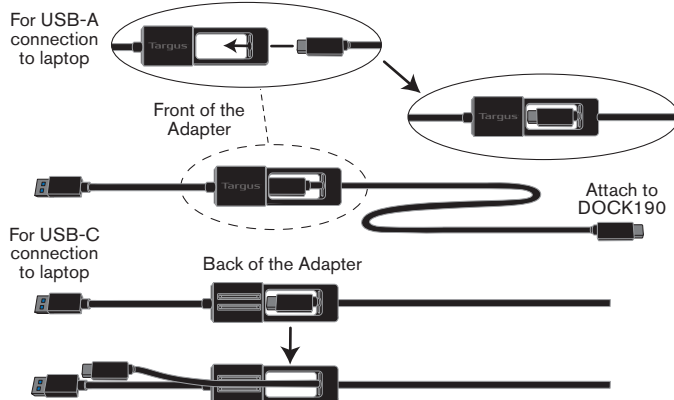

#### Power Setup

1. Locate the correct power tip (test fit in laptop if needed)

2. Connect to the power cord

3. Connect to your laptop and docking station

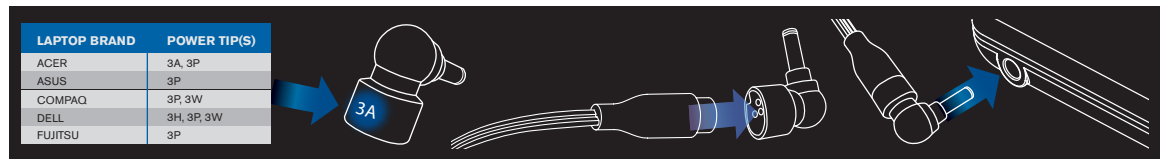

LAPTOP BRAND	POWER TIP(S)
ACER	3A, 3P
ASUS	3P
COMPAQ	3P, 3W
DELL	3H, 3P, 3W
FUJITSU	3P

LAPTOP BRAND	POWER TIP(S)	LAPTOP BRAND	POWER TIP(S)
ACER	3A, 3P	GATEWAY	3A, 3P
ASUS	3P	HP	3H2, 3P, 3W
COMPAQ	3P, 3W	IBM/LENOVO	3I2, 3P, 3X9
DELL	3H, 3P, 3W	TOSHIBA	3P
FUJITSU	3P		

#### Specifications

- 2 x DisplayPort (DP++; DP1.2) / HDMI Port (HDMI 2.0)
- 4 x USB 3.0 downstream ports (port marked with ⚡ supports BC 1.2 and iOS device charging at 2.4A max)
- 1 x USB-C upstream port with supporting Power Delivery 2.0 Profile 5 (up to 100W max. charging)
- 1 x USB-C downstream port (USB 3.0, data transfer only)
- Gigabit Ethernet
- Audio In/Out ports (3.5mm headset connector)
- Security lock slot
- USB-C cable
- LED Power Indicator
- Power ON/OFF button
- DC Power In: 20.5V, 150W
- DC Power Out: 19.5V 90W max

## Docking Station Diagram

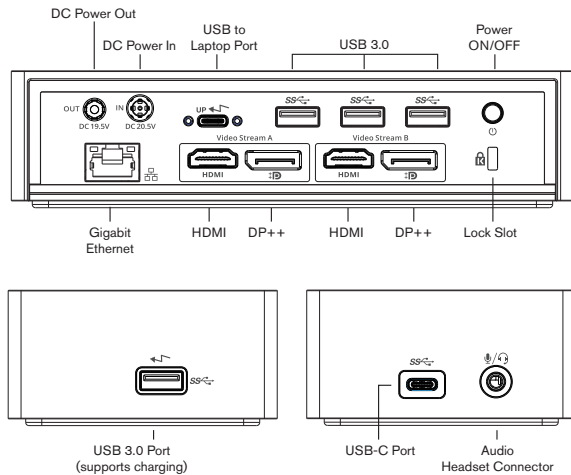

## System Requirements

### Hardware

- Thunderbolt 3 or USB-C port
- Power Delivery charging support requires host computer support Power Delivery 2.0 charging (up to 100W max)

### Operating System (any of the following)

- Microsoft Windows® 7, Windows® 8, Windows® 8.1, or Windows® 10 (32/64-bit)
- Mac OS® X v10.8 or later
- Android 5.0 or later
- Chromebooks
- Ubuntu 14.04.x LTS and 16.04 LTS on x86 platform

Visit [www.targus.com](http://www.targus.com) for a list of the latest compatible operating systems

## Windows Setup

To ensure the best Windows performance, please be sure to update your host PC Display Adaptor and USB 3.0 Drivers. These updates are often available from your IT department or from the PC manufacturer if you have Administrator rights to download and install drivers for your PC.

Welcome to your Targus Universal Docking Station DisplayLink Manager. The DisplayLink Manager software, if not already installed, can be downloaded from a Windows Update server or from [www.targus.com](http://www.targus.com). It is represented by the  icon in the Windows Task Tray and allows you to easily connect additional monitors to your laptop or desktop via the Targus Docking Station. Using the Windows Control Panel Display Screen Resolution window, the connected monitors can be configured to either mirror your main screen, or extend the Windows desktop allowing visibility of more applications at the same time. The DisplayLink USB Graphics devices can also be configured to be the main display.

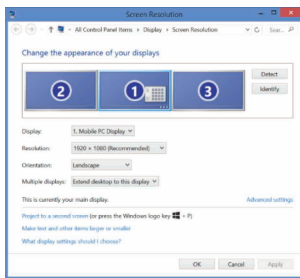

The DisplayLink Manager allows full configuration of all additional USB displays, including:

- Support for addition USB Displays in Windows 7, 8, 8.1, 10 and later
- Resolution up to 4096 x 2160 for Displayport or HDMI
- Display orientation and location modification
- Layout of displays

DisplayLink software also provides drivers for Sound and Ethernet built-in. These can also be selected in the Windows Control Panel.

## OS-X Setup

Upon installation of the DisplayLink software for OS-X available at [www.targus.com](http://www.targus.com), Macbook users can use the System Preferences for Displays to adjust the external monitors. OS-X allows configuration of all additional USB displays, including:

- Support for additional USB Displays in OS-X 10.9 or later
- Resolution up to 4096 x 2160 for Displayport or HDMI
- Display orientation and location modification
- Layout of displays

DisplayLink software also provides drivers for Sound and Ethernet built-in.

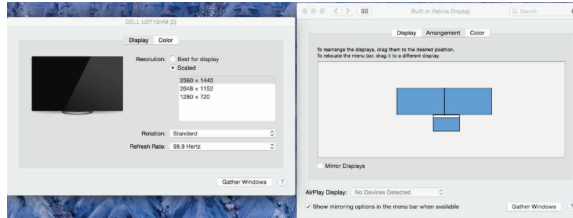

## Android Setup

Install the DisplayLink Desktop application for Android 5.0 and later from the Google Play Store. Enable USB Debugging/Host mode on your Android device.

## Technical Support

For technical questions, please visit:

US

Internet: <http://targus.com/us/support>

Australia

Internet: <http://www.targus.com/au/support>

Email: [infoaust@targus.com](mailto:infoaust@targus.com)

Telephone: 1800-641-645

New Zealand

Telephone: 0800-633-222

Latin America

Email: [soporte@targus.com](mailto:soporte@targus.com)

## Product Registration

Targus recommends that you register your Targus accessory shortly after purchasing it. Go to:

[http://targus.com/us/product\\_registration](http://targus.com/us/product_registration)

You will need to provide your full name, email address, country of residence and product information.

## Regulatory Compliance

This device complies with Part 15 of the FCC Rules. Operation is subject to the following two conditions: (1) This device may not cause harmful interference, and (2) This device must accept any interference received, including interference that may cause undesired operations.

## FCC Statement (Tested to Comply)

This device complies with Part 15 of the FCC Rules. Operation is subject to the following two conditions:

This device may not cause harmful interference, and

This device must accept any interference received, including interference that may cause undesired operation.

Warning: Changes or modifications not expressly approved by the party responsible for compliance could void the user's authority to operate the equipment.

NOTE: This equipment has been tested and found to comply with the limits for a Class B digital device, pursuant to Part 15 of the FCC Rules. These limits are designed to provide reasonable protection against harmful interference in a residential installation.

This equipment generates, uses, and can radiate radio frequency energy and, if not installed and used in accordance with the instructions, may cause harmful interference to radio communications. However, there is no guarantee that interference will not occur in a particular installation. If this equipment does cause harmful interference to radio or television reception, which can be determined by turning the equipment off and on, the user is encouraged to try to correct the interference by one or more of the following measures:

- Reorient or relocate the receiving antenna.
- Increase the separation between the equipment and receiver.
- Connect the equipment into an outlet on a circuit different from that to which the receiver is connected.
- Consult the dealer or an experienced radio/TV technician for help.

## Declaration of Conformity

Hereby, Targus declares that this device is in compliance with the essential requirements and other relevant provisions of Directive: 2014/30/EU and 2014/35/EU.

## Three Year Warranty

We pride ourselves on the quality of our products. For complete warranty details and a list of our worldwide offices, please visit [www.targus.com](http://www.targus.com). Targus product warranty does not cover any device or product that is not manufactured by Targus (including, but not limited to, laptops, smartphones, devices, or any other product that may be used in connection with the Targus product). Australian customers: For complete warranty details see warranty statement enclosed.

Targus is a registered trademark of Targus International LLC in the U.S. and in certain other countries. Microsoft, Windows, and Windows Vista are registered trademarks or trademarks of Microsoft Corporation in the United States and/or other countries. Broadcom and the Broadcom logo are trademarks of Broadcom Corp. Bluetooth and the Bluetooth logos are trademarks owned by Bluetooth SIG, Inc., U.S.A. and licensed to Broadcom Corp. All logos and registered trademarks are the property of their respective owners. ©2018 Targus, 1211 North Miller Street, Anaheim, CA 92806. All rights reserved.

### AUSTRALIAN AND NEW ZEALAND CONSUMERS ONLY

Thank you for your purchase. Targus warrants to the original purchaser that its products are free from defects in materials and workmanship, during the specified warranty period, and lasts as long as the original purchaser owns the product. The warranty period is stated on the packaging or in the documentation provided with this Targus product. Targus' Limited Product Warranty excludes damage caused by accident, neglect, abuse, misuse, improper care, normal wear and tear, ownership transfer, or alteration. The limited warranty also excludes any product that is not manufactured by Targus (including, without limitation, laptops, smartphones, devices, tablets, or any other non-Targus item) that is used in connection with the Targus product.

In the event that the Targus product has a defect in materials or workmanship Targus will, after receiving a warranty claim and inspecting the product, at its discretion, do one of the following: repair, replace, or refund with the same or a similar product (or part) of no lesser quality and ship it to the original purchaser at Targus' expense. As part of this inspection, proof of purchase will be required. There is no charge for inspection. To make a warranty claim, please contact Targus Australia or New Zealand (see details below), or return the product to the place of purchase. The original purchaser must bear the cost of the delivery to Targus.

Under Australian and/or New Zealand Consumer Laws, in addition to any warranty Targus gives, our products come with guarantees that cannot be excluded. You are entitled to a replacement or refund for a major failure and compensation for any other reasonably foreseeable loss or damage. You are entitled to have the products repaired or replaced if they fail to be of acceptable quality and the failure does not amount to a major failure.

For any warranty question, contact Targus Australia Pty. Ltd. (i) by mail at Suite 2, Level 8, 5 Rider Boulevard, Rhodes NSW 2138, by phone AUS 1800 641 645 or NZ 0800 633 222 or by Email: [infoaust@targus.com](mailto:infoaust@targus.com). For additional information, check out our website at [targus.com/au/warranty](http://targus.com/au/warranty).