

Voltage Regulator and Battery Charger

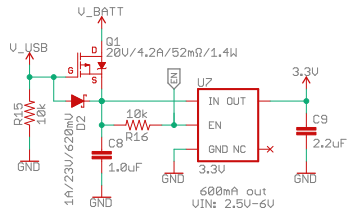

Lithium-Polymer Battery Charger (1-cell)

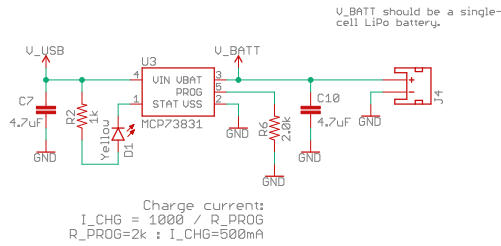

Debug Header

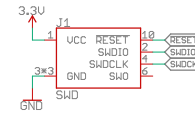

USB Connector

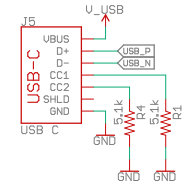

Raspberry Pi RP2040

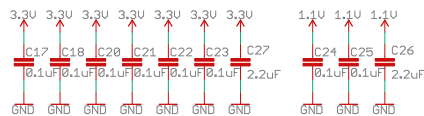
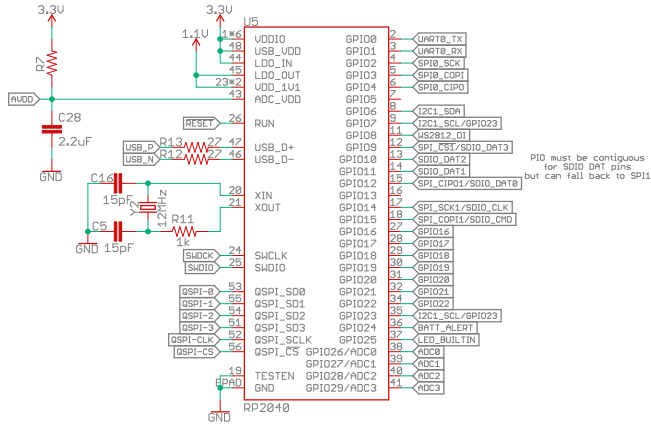

WS2812

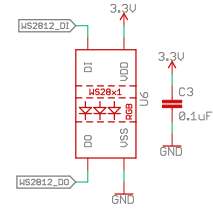

Quic Connector

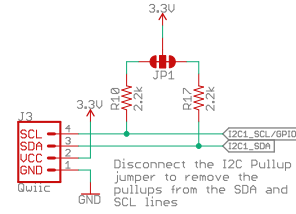

16MB / 128mbit Flash

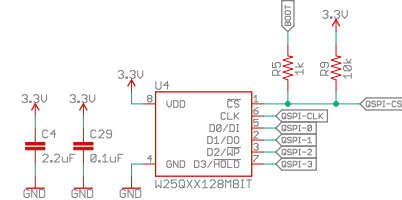

Battery Fuel Gauge

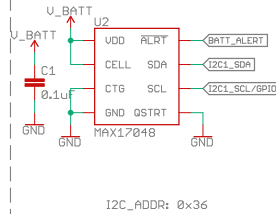

uSD Connector

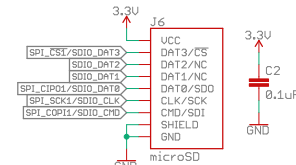

Headers

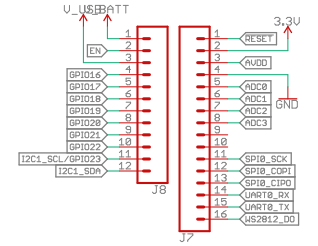

Status LED

Power LED

Boot Select

Reset Button

Released under the Creative Commons Attribution Share-Alike 4.0 License
<https://creativecommons.org/licenses/by-sa/4.0/>
 TITLE: RP2040_Thing_Plus THIS IS A FOUR-LAYER BOARD!
 Design by: _____ REV: v1.0
 Date: 1/7/2021 8:58 AM Sheet: 1/1