

CARMEN-50-S-C

~24° spot beam. Assembly with holder C compatible with LEDiL HEKLA.

TECHNICAL SPECIFICATIONS:

Dimensions	Ø 50.0 mm
Height	25.5 mm
Fastening	socket
Colour	black
Box size	476 x 273 x 292 mm
Box weight	6.9 kg
Quantity in Box	308 pcs
ROHS compliant	yes ⓘ





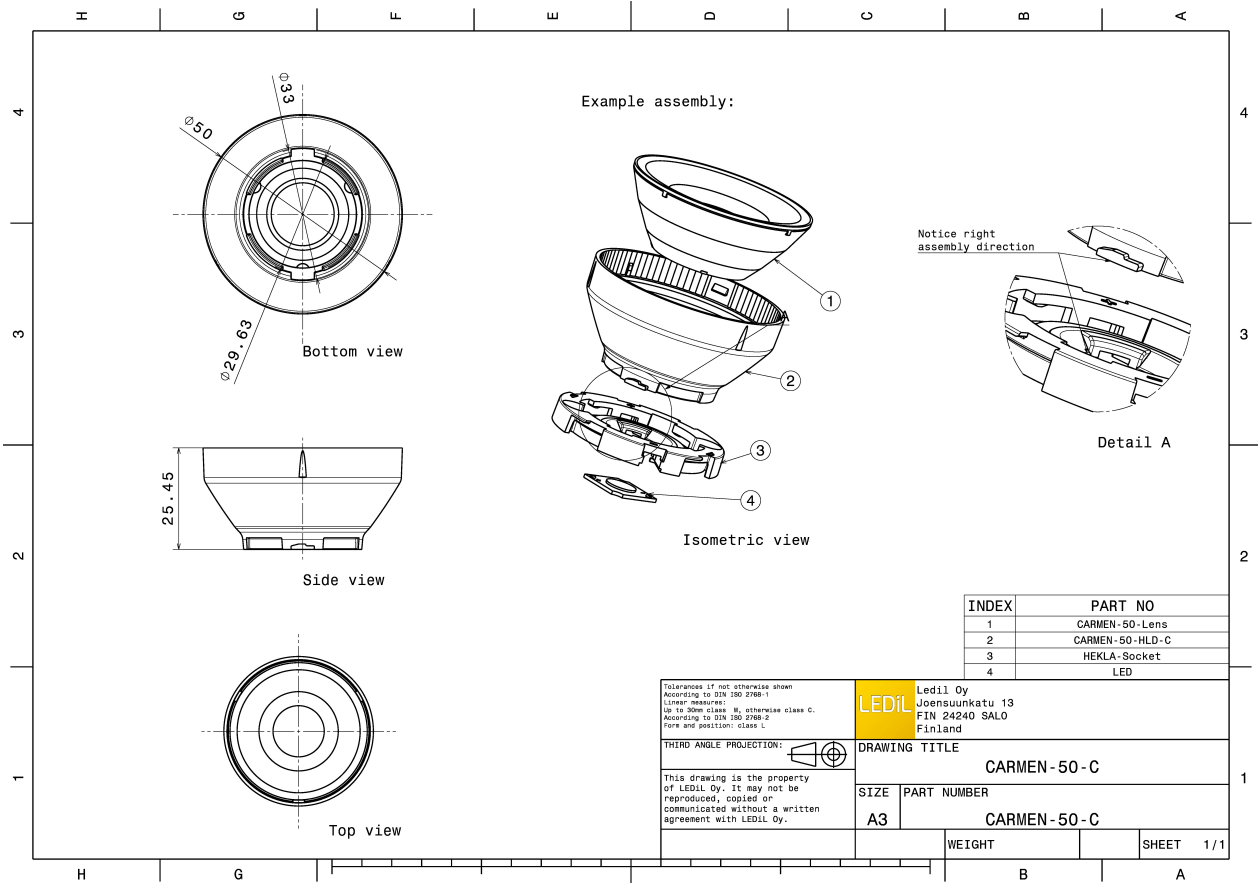

MATERIAL SPECIFICATIONS:

Component	Type	Material	Colour
CARMEN-50-S	Single lens	PMMA	
CARMEN-50-HLD-C	Holder	PC	

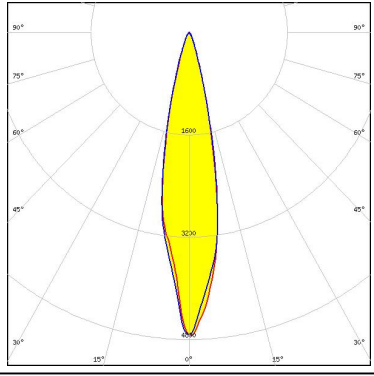
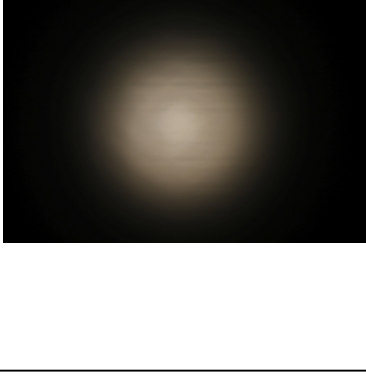
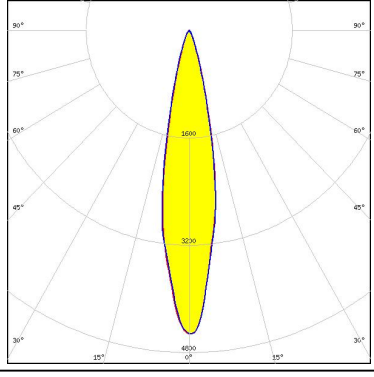

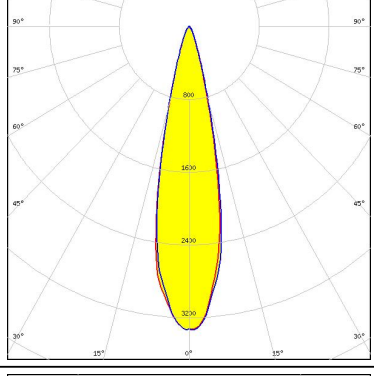
PHOTOMETRIC DATA (MEASURED):

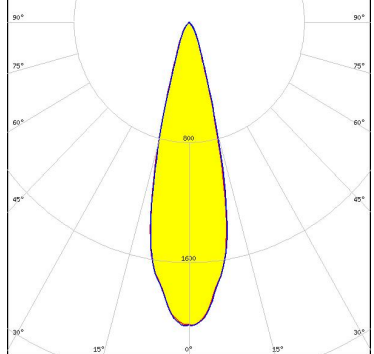
<p>bridgelux.</p> <p>LED V4 HD FWHM 21.0° Efficiency 79 % Peak intensity 4.700 cd/lm LEDs/each optic 1 Light colour White Required components: F15253_HEKLA-SOCKET-A</p>		
<p>bridgelux.</p> <p>LED V6 HD FWHM 20.0° Efficiency 73 % Peak intensity 4.500 cd/lm LEDs/each optic 1 Light colour White Required components: F15255_HEKLA-SOCKET-C</p>		
<p>bridgelux.</p> <p>LED V9 HD FWHM 23.0° Efficiency 65 % Peak intensity 3.300 cd/lm LEDs/each optic 1 Light colour White Required components: F15859_HEKLA-SOCKET-I</p>		
<p>bridgelux.</p> <p>LED VERO13 FWHM 27.0° Efficiency 53 % Peak intensity 2.027 cd/lm LEDs/each optic 1 Light colour White Required components: C16142_HEKLA-SOCKET-K</p>		

PHOTOMETRIC DATA (MEASURED):

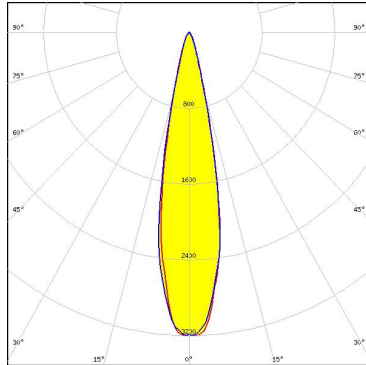
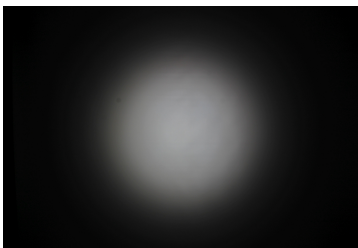
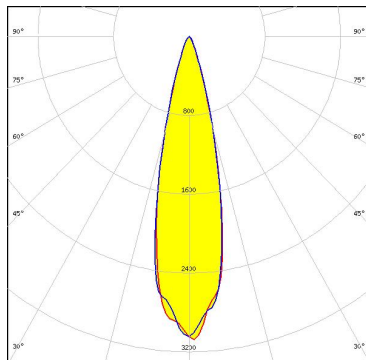
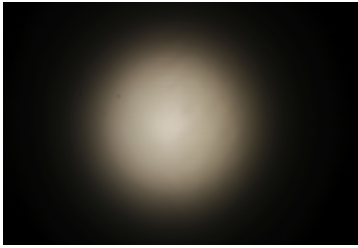
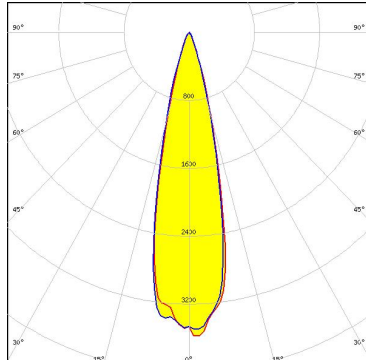
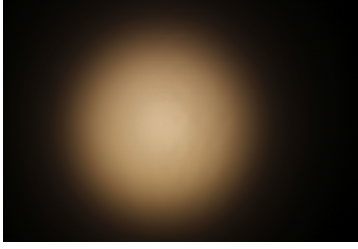
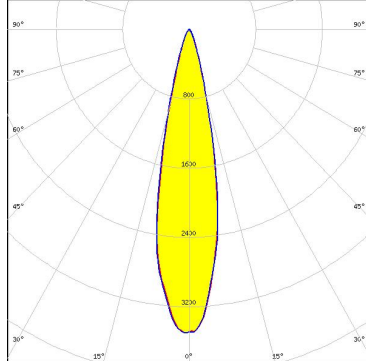
<p>bridgelux</p> <p>LED Vesta TW 9mm (9W) DP FWHM 22.0° Efficiency 55 % Peak intensity 3.203 cd/lm LEDs/each optic 1 Light colour White Required components: C16142_HEKLA-SOCKET-K Bender Wirth: 489 Typ L8</p>		
<p>CITIZEN</p> <p>LED CLL02x/CLU02x (LES10) FWHM 24.0° Efficiency 66 % Peak intensity 3.100 cd/lm LEDs/each optic 1 Light colour White Required components: F15255_HEKLA-SOCKET-C</p>		
<p>CITIZEN</p> <p>LED CLU700/701/702 FWHM 19.0° Efficiency 73 % Peak intensity 5.300 cd/lm LEDs/each optic 1 Light colour White Required components: F15255_HEKLA-SOCKET-C</p>		
<p>CITIZEN</p> <p>LED CLU710/711 FWHM 22.0° Efficiency 65 % Peak intensity 3.506 cd/lm LEDs/each optic 1 Light colour White Required components: F15859_HEKLA-SOCKET-I</p>		

PHOTOMETRIC DATA (MEASURED):



LED CMA1516
 FWHM 25.0°
 Efficiency 68 %
 Peak intensity 3.000 cd/lm
 LEDs/each optic 1
 Light colour White
 Required components:
 F15256_HEKLA-SOCKET-D

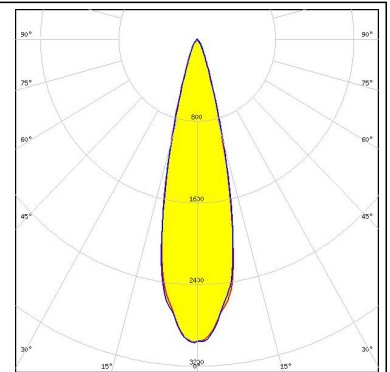

LED CMT14xx
 FWHM 25.0°
 Efficiency 44 %
 Peak intensity 1.900 cd/lm
 LEDs/each optic 1
 Light colour White
 Required components:
 F15255_HEKLA-SOCKET-C

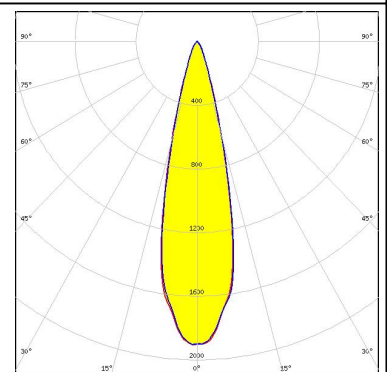
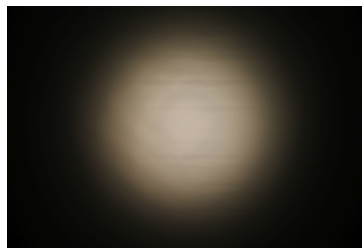

LED CXA/B 13xx
 FWHM 21.0°
 Efficiency 76 %
 Peak intensity 4.500 cd/lm
 LEDs/each optic 1
 Light colour White
 Required components:
 F15956_HEKLA-SOCKET-J

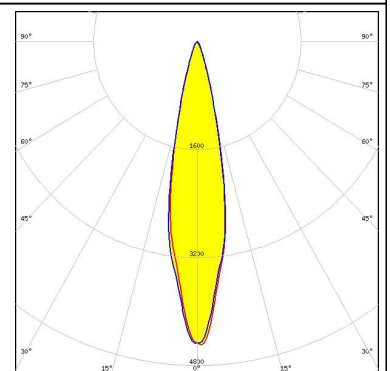
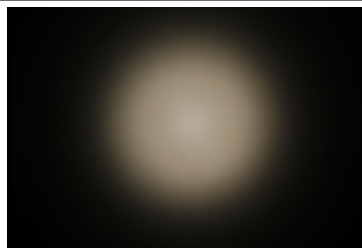

LED CXA/B 13xx
 FWHM 22.0°
 Efficiency 77 %
 Peak intensity 4.500 cd/lm
 LEDs/each optic 1
 Light colour White
 Required components:
 F15956_HEKLA-SOCKET-J

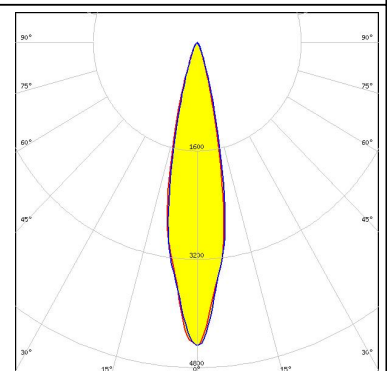

PHOTOMETRIC DATA (MEASURED):



LED CXA/B 15xx
 FWHM 24.0°
 Efficiency 69 %
 Peak intensity 3.400 cd/lm
 LEDs/each optic 1
 Light colour White
 Required components:
 F15256_HEKLA-SOCKET-D

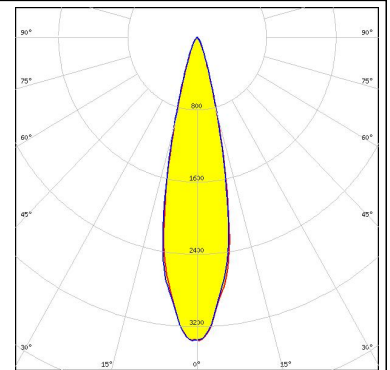

LED LUXEON CoB 1202HD
 FWHM 21.0°
 Efficiency 73 %
 Peak intensity 4.400 cd/lm
 LEDs/each optic 1
 Light colour White
 Required components:
 F15848_HEKLA-SOCKET-G

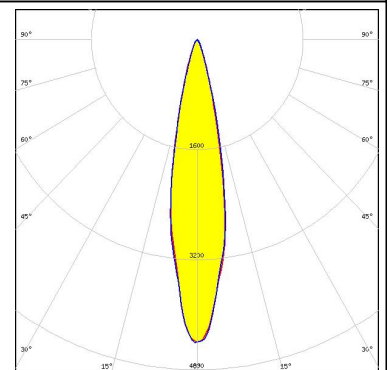
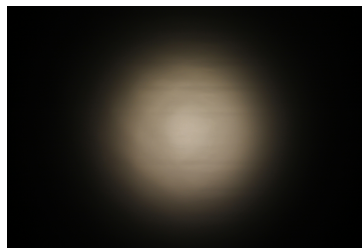

LED LUXEON CoB 1202s
 FWHM 21.0°
 Efficiency 75 %
 Peak intensity 4.700 cd/lm
 LEDs/each optic 1
 Light colour White
 Required components:
 F15848_HEKLA-SOCKET-G

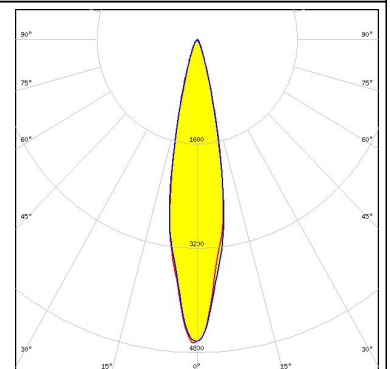
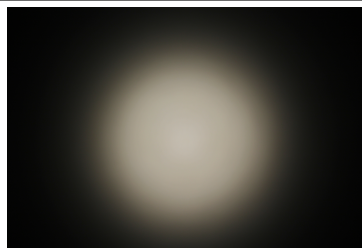

LED CDM-9 (Dim-To-Warm)
 FWHM 21.0°
 Efficiency 57 %
 Peak intensity 3.700 cd/lm
 LEDs/each optic 1
 Light colour White
 Required components:
 C16142_HEKLA-SOCKET-K
 Bender Wirth: 490 Typ L8

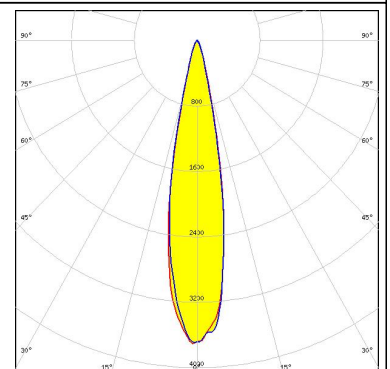
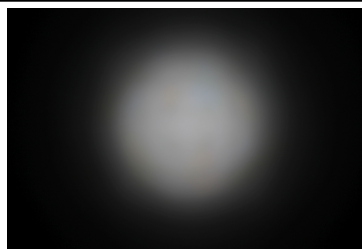

PHOTOMETRIC DATA (MEASURED):



LED CXM-4
 FWHM 18.0°
 Efficiency 76 %
 Peak intensity 5.522 cd/lm
 LEDs/each optic 1
 Light colour White
 Required components:
 F15255_HEKLA-SOCKET-C

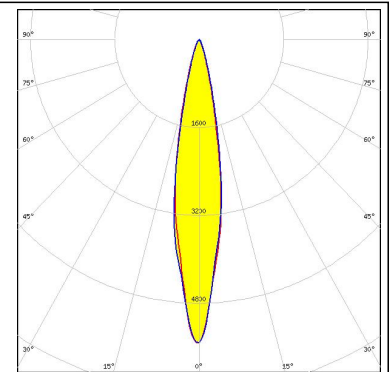
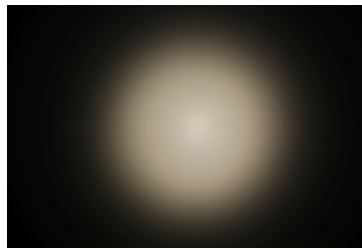

LED CxM-9 (13.5x13.5)
 FWHM 24.0°
 Efficiency 67 %
 Peak intensity 3.100 cd/lm
 LEDs/each optic 1
 Light colour White
 Required components:
 F15255_HEKLA-SOCKET-C

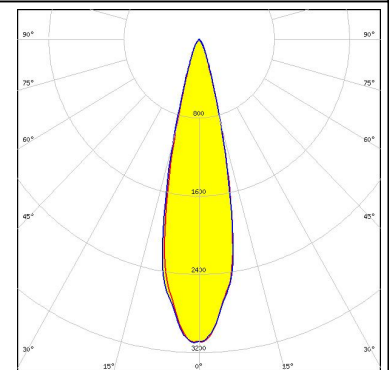
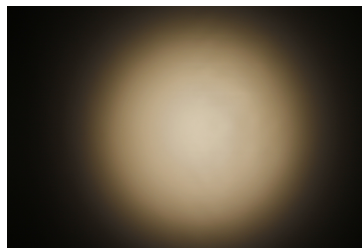

LED COB S-Type (LES 7)
 FWHM 22.0°
 Efficiency 73 %
 Peak intensity 4.100 cd/lm
 LEDs/each optic 1
 Light colour White
 Required components:
 F15848_HEKLA-SOCKET-G

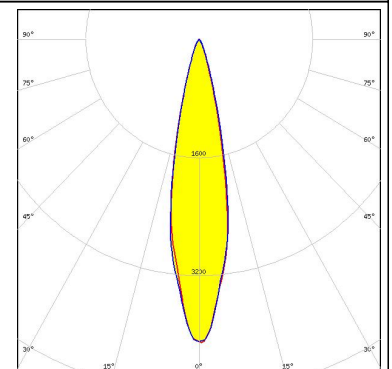
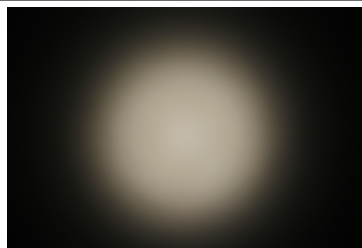

LED NJCWL024Z-V1MT: COB L-Type Tunable White
 FWHM 17.0°
 Efficiency 56 %
 Peak intensity 4.700 cd/lm
 LEDs/each optic 1
 Light colour White
 Required components:
 C16142_HEKLA-SOCKET-K
 Bender Wirth: 497 Typ L8

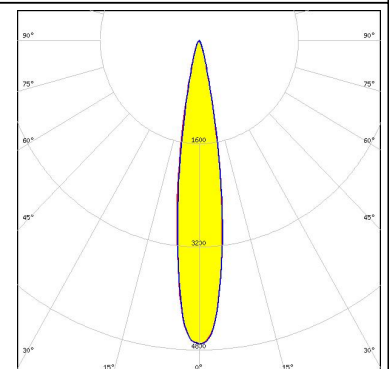

PHOTOMETRIC DATA (MEASURED):

PHILIPS

LED Fortimo SLM L09 CoB
FWHM 24.0°
Efficiency 65 %
Peak intensity 3.100 cd/lm
LEDs/each optic 1
Light colour White
Required components:
F15858_HEKLA-SOCKET-H

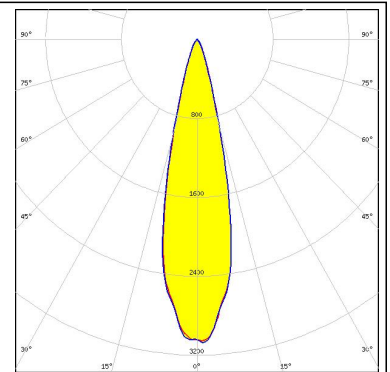
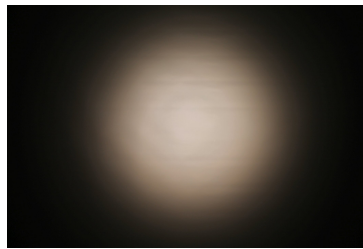

SAMSUNG

LED COB D Series LES 9.8 mm
FWHM 25.0°
Efficiency 67 %
Peak intensity 3.000 cd/lm
LEDs/each optic 1
Light colour White
Required components:
F15255_HEKLA-SOCKET-C

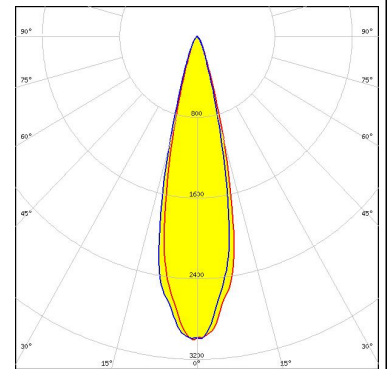

SAMSUNG

LED LC010C G2
FWHM 19.0°
Efficiency 74 %
Peak intensity 5.300 cd/lm
LEDs/each optic 1
Light colour White
Required components:
F15255_HEKLA-SOCKET-C

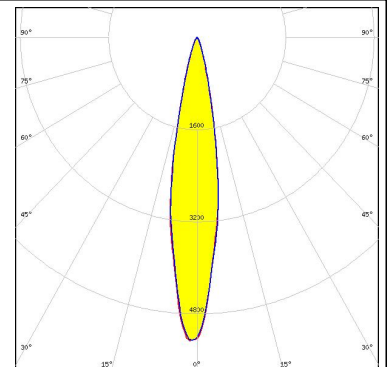
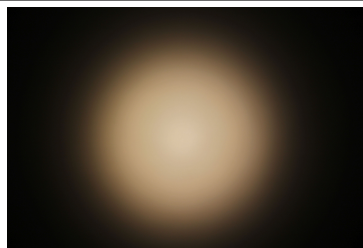

SAMSUNG

LED LC020C G2
FWHM 23.0°
Efficiency 65 %
Peak intensity 3.300 cd/lm
LEDs/each optic 1
Light colour White
Required components:
F15859_HEKLA-SOCKET-I

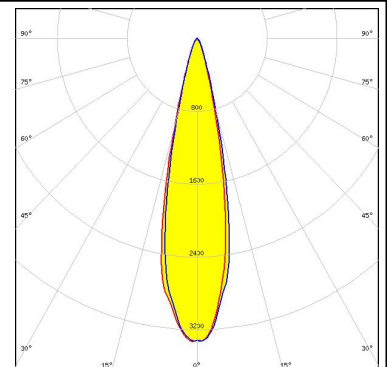
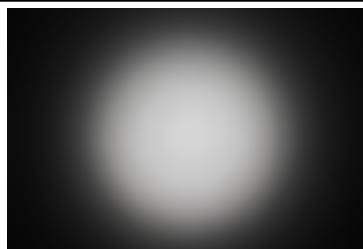

PHOTOMETRIC DATA (MEASURED):

TRIDONIC

LED SLE G7 LES09
 FWHM 23.0°
 Efficiency 69 %
 Peak intensity 3.500 cd/lm
 LEDs/each optic 1
 Light colour White
 Required components:
 F15255_HEKLA-SOCKET-C

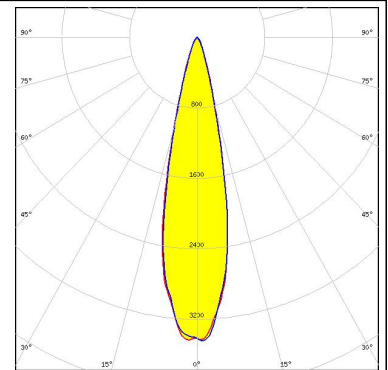
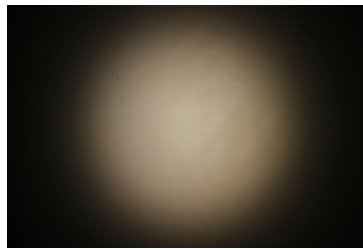

TRIDONIC

LED SLE G7 LES13
 FWHM 31.0°
 Efficiency 58 %
 Peak intensity 1.800 cd/lm
 LEDs/each optic 1
 Light colour White
 Required components:
 F15859_HEKLA-SOCKET-I

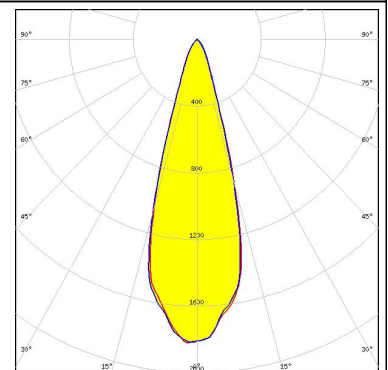
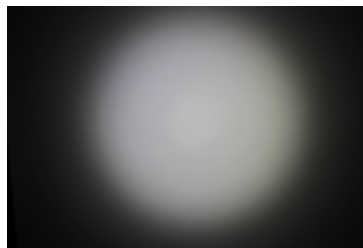

XICATO

LED XOB 6 mm
 FWHM 19.0°
 Efficiency 73 %
 Peak intensity 4.870 cd/lm
 LEDs/each optic 1
 Light colour White
 Required components:
 F15255_HEKLA-SOCKET-C

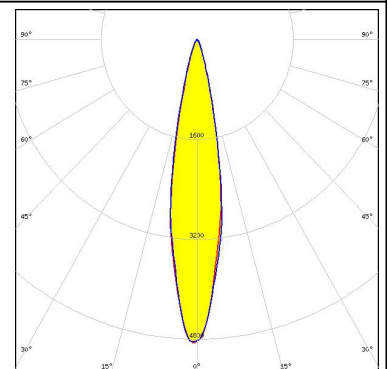
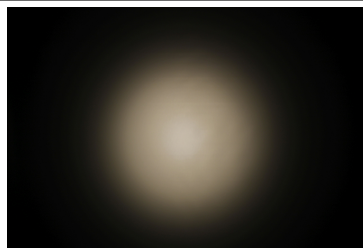





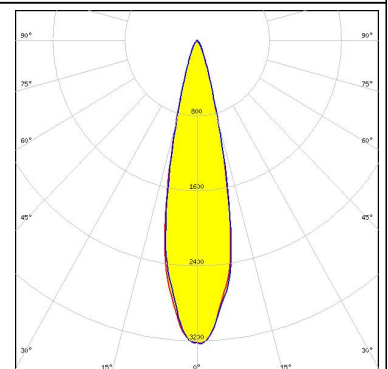
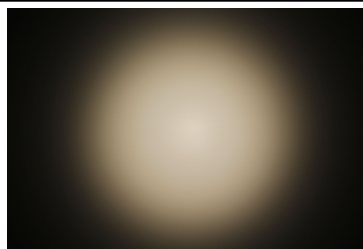

XICATO

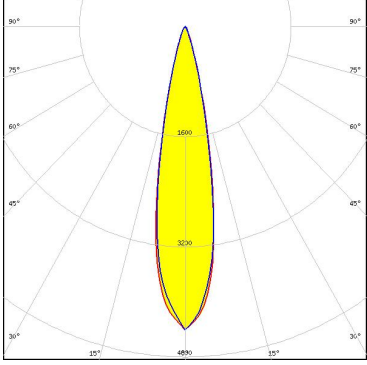
LED XOB 9.8 mm
 FWHM 24.0°
 Efficiency 67 %
 Peak intensity 3.232 cd/lm
 LEDs/each optic 1
 Light colour White
 Required components:
 F15255_HEKLA-SOCKET-C

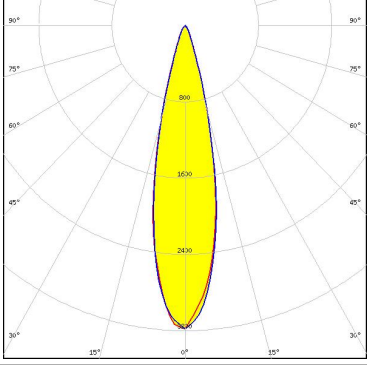

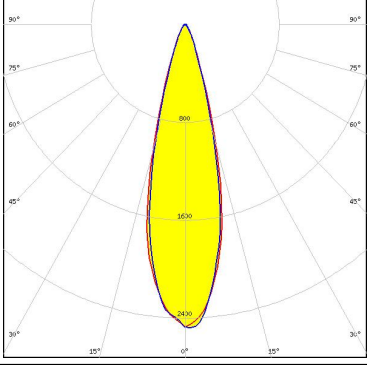
PHOTOMETRIC DATA (SIMULATED):

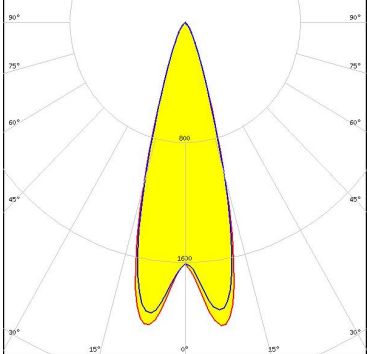
<p> bridgelux</p> <p>LED V6 Gen6 FWHM 21.0° Efficiency 71 % Peak intensity 4.400 cd/lm LEDs/each optic 1 Light colour White Required components: F15253_HEKLA-SOCKET-A</p>	
<p> bridgelux</p> <p>LED VERO10 FWHM 24.0° Efficiency 64 % Peak intensity 3.180 cd/lm LEDs/each optic 1 Light colour White Required components: F15616_HEKLA-SOCKET-F</p>	
<p> bridgelux</p> <p>LED VERO13 FWHM 27.0° Efficiency 66 % Peak intensity 2.500 cd/lm LEDs/each optic 1 Light colour White Required components: C16142_HEKLA-SOCKET-K</p>	
<p> NICHIA</p> <p>LED COB S-Type (LES 6) FWHM 30.0° Efficiency 62 % Peak intensity 2.058 cd/lm LEDs/each optic 1 Light colour White Required components: F15848_HEKLA-SOCKET-G</p>	

PHOTOMETRIC DATA (SIMULATED):

SAMSUNG

LED LH231B
FWHM 23.0°
Efficiency 63 %
Peak intensity 3.017 cd/lm
LEDs/each optic 7
Light colour White
Required components:
F15255_HEKLA-SOCKET-C

XICATO

LED XTM - 9mm LES
FWHM 25.0°
Efficiency 67 %
Peak intensity 3.000 cd/lm
LEDs/each optic 1
Light colour White
Required components:
C15743_XTM-ADAPTER-50-B

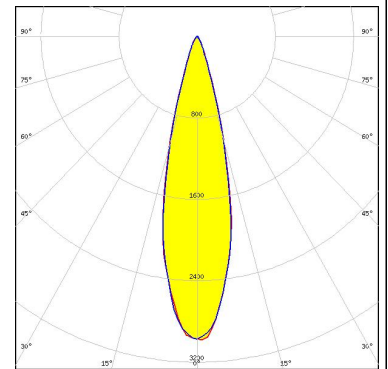

GENERAL INFORMATION:

NOTE: The typical beam angle will be changed by different color, chip size and chip position tolerance. The typical total beam angle is the full angle measured where the luminous intensity is half of the peak value.

Due to use of high power COB's with this product, special attention to proper thermal design is highly recommended. LEDiL has no liability for direct, indirect or consecutive damages arising from the LEDiL products being used outside of the recommended temperature range.

MATERIALS:

As part of our continuous research and improvement processes, and to ensure the best possible quality and availability of our products, LEDiL reserves the right to change material grades without notice.

PRODUCT DATA USER AGREEMENT AND DISCLAIMER:

The measured data in the provided downloadable LEDiL Product Datasheets and Mechanical 2D-Drawings is rounded and provided as reference for planning. LEDiL Oy's optical specifications have been verified by conducting performance testing of the products in accordance with the company's quality system. The reported data are averaged results of multiple measurements with typical variation. LEDiL Oy reserves the right to without prior notification make changes and improvements to its products.

LEDiL Oy assumes neither warranty, nor guarantee nor any other liability of any kind for the contents and correctness of the provided data. The provided data has been generated with highest diligence but the provided data may in reality not represent the complete possible variation range of all intrinsic parameters. Therefore, in certain cases a deviation from the provided data could occur.

LEDiL Oy reserves the right to undertake technical changes of its products without further notification which could lead to changes in the provided data. LEDiL Oy assumes no liability of any kind for the possible deviation from any provided data or any other damage resulting from the usage of the provided data.

The user agrees to this disclaimer and user agreement with the download or usage of the provided files.

LEDiL Oy

Joensuunkatu 13
FI-24240 SALO
Finland

LEDiL Inc.

228 West Page Street
Suite D
Sycamore IL 60178
USA

Local sales and technical support

www.ledil.com/where_to_buy

Shipping locations

Salo, Finland
Hong Kong, China

Distribution Partners

www.ledil.com/where_to_buy