

Programmable Controllers

CJ2 FAMILY

New PLCs with a proven track record



» Flexibility in communication

» Faster machine development

» Innovation through evolution

Innovation without growing pains

As a modern machine manufacturer you need to continuously increase the intelligence and flexibility of your product to remain competitive. But you also need to be absolutely certain that it all works perfectly, first time, every time.

The CJ2 is the result of years of experience as market leader in the field of modular controllers and represents a logical next step in controller design. It offers greater performance and faster I/O response as well as extreme scalability - so you will only need one family. In addition, programming, debugging and networking are faster and easier. Welcome to the new CJ2 Family: built to give you innovation without growing pains.

Although CJ2 is a can directly replace any CJ1 CPU, it offers the following additional significant advantages:

Open to the world

Data communication is via standard Ethernet port with EtherNet/IP Data Link function.

Advanced motion control

CJ2 units offer multi-axes synchronous control, and can replace expensive motion controllers.

High-speed

Faster program execution and immediate I/O refreshing enables flexible machine control.

Learn one, know them all

Thanks to the wide variety of CPUs with consistent architecture across all PLC families, you only need to learn one, and you will know them all.

Highly flexible

Adapt the PLC to your needs with the wide variety of compatible CJ1 Family I/O units (nearly 100).





The wide range of CPUs means you need only to get familiar with one PLC family for use in everything from simple stand-alone applications up to networked, high-speed machines.

Inspired by proven technology

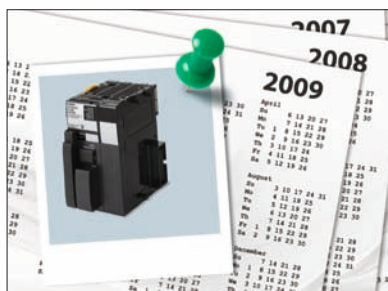

Proved track record

The CJ2 Family is based on the highly popular CJ1, which after its launch in 2001 is operating in an extraordinary variety of applications all over the world. Now, as the natural successor, the CJ2 combines that field-proven technology with a wider choice of CPUs, more speed and memory, and a wider variety of communication interfaces.

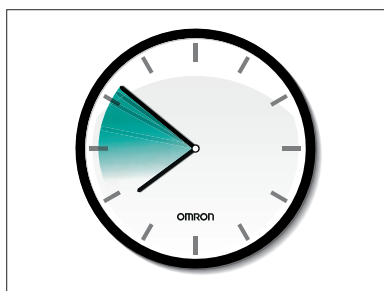

Faster development

Tag-based communications technology will simplify the interfacing of the PLC to the outside world. On-line debugging improvements also help to accelerate software development so you can change the code and test the results quickly. The added function block memory will allow you improve to program structure and reuse of code even in the the entry-level models.

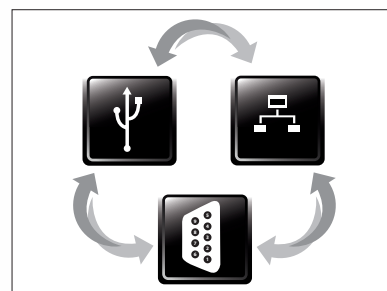

Talks to all

The CJ2 Family supports major open networking technologies including:

- Ethernet-based communication based on open industrial standards
- Serial communications over RS-232 C, RS-422, RS-485 and USB
- The major open Fieldbus standards
- Fast and accurate motion control networks.

Built to answer your needs

Omron has used its long experience as a specialist machine automation supplier to develop CJ2. The result is an extremely reliable PLC that is also a powerful example of our commitment to continuous improvement. The CJ2 Family is a major opportunity to innovate and simultaneously reduce cost now and in the future. It's the obvious choice for modern machine builders.



Power supply Pulse I/O CPU

Wide range CPU capacity

To stay ahead in the machine-building business, you need to grow with your end-user's needs. Faster production, better quality control and better traceability require more speed and more memory. That's why the CJ2 Family offers a wide range of CPUs to suit any task. From 5 Ksteps program capacity and 64 Kwords memory, right up to 500 Ksteps capacity and 832 Kwords.

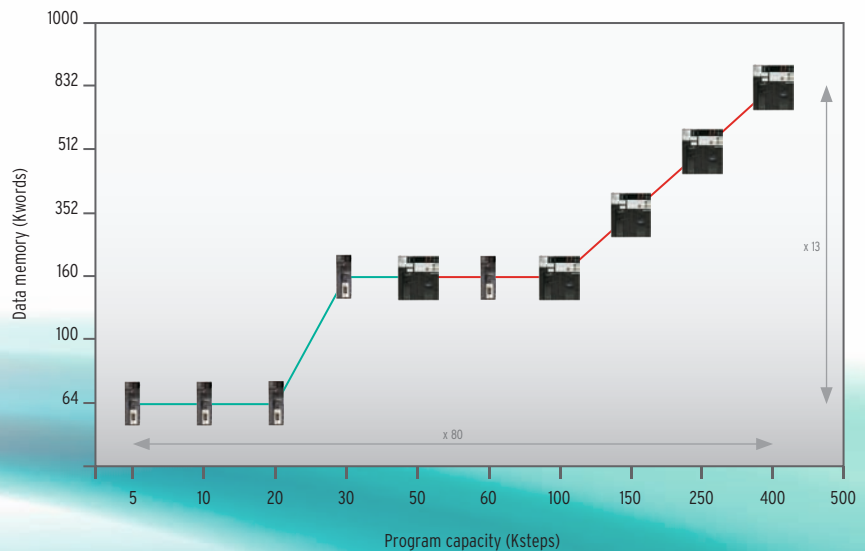
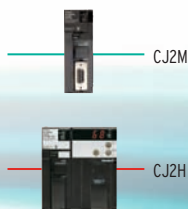



Higher precision

In addition to the greater CPU processing performance, Omron has also added new high-speed I/O units, such as analog input units with 20 μs conversion time, while new PLC instructions provide immediate access to fast I/O data. The result is even more real-time reliability.

Select what you need

With CJ2 you can also still connect to the existing CJ1 I/O units. You can benefit from CJ2's improvements without redesigning the entire system.

Easy connection by USB

Simply connect the cable, with no settings required

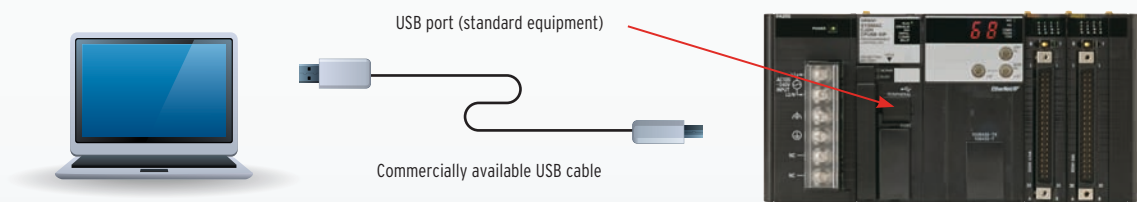

A CJ2 CPU Unit on an EtherNet/IP network can be accessed via USB, with no need for routing tables



One family - two performance classes

CJ2M for basic machine automation

The CJ2M Series is ideal for packaging and general machine automation needs. Connectivity is assured thanks to the built-in USB port and the choice of Ethernet and RS-232C/422/485 interfaces on the CPU.

- Always accessible through standard USB port
- Standard Ethernet port with EtherNet/IP Data Link function
- Wide range of program capacities, from 5 Ksteps to 60 Ksteps
- Pulse I/O add-on modules have a special connection to the CPU and are controlled by convenient positioning instructions
- Serial option board for CJ2M-CPU3*
- Dedicated function block memory ensures efficient execution of function block software modules

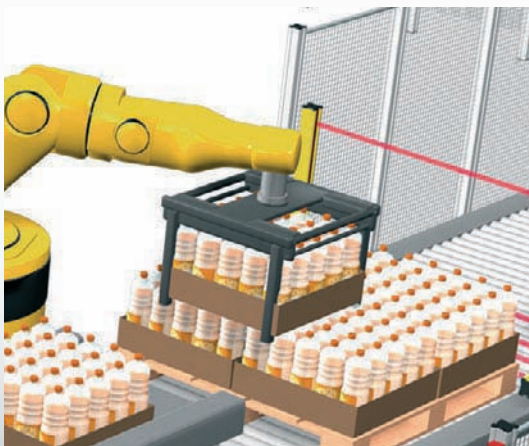
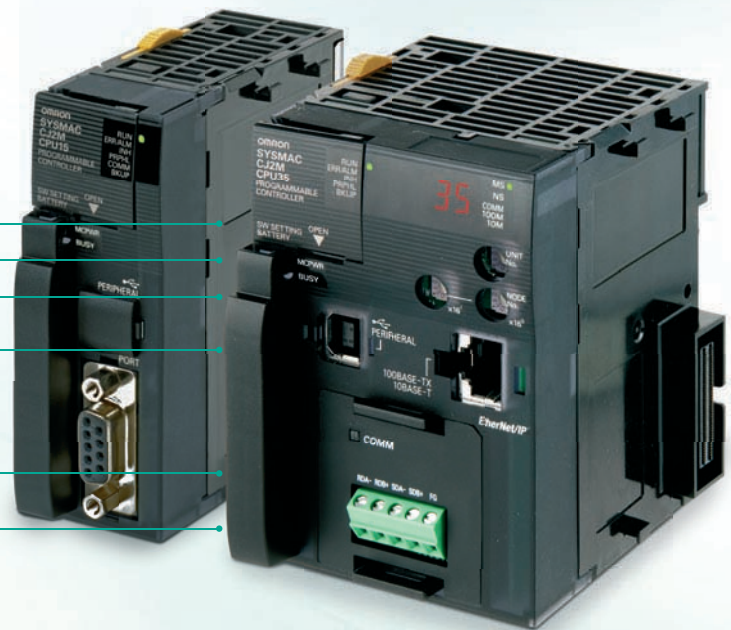

Pulse I/O modules

By mounting optional pulse I/O modules, you can extend the functionality of any CJ2M CPU with:

- interrupt inputs
- quick-response inputs
- high-speed counters
- incremental encoder inputs
- pulse frequency control outputs
- pulse width control outputs

Up to two modules can be mounted per CPU, allowing direct control of four motion axes. Using dedicated instructions, these axes can be controlled directly by the PLC program, without communication delays.

* Supported by the CJ2M CPU Unit with version 2.0 or later.

CJ2H for high speed, high capacity

The CJ2H Series is ideal for advanced machine automation needs such as those required in image processing inspection of electrical components and high speed sorting on conveyors.

Advanced motion control - made simple

The CJ2H's advanced motion control avoids the use of expensive motion controllers. Synchronized control is possible on up to 20 axes by using just five Position Control units (High-speed type). And, programming is easy – simply paste an electronic cam function block into a synchronized interrupt task.



- Always accessible through standard USB port
- Standard Ethernet port with EtherNet/IP Data Link function
- High program capacity of up to 400K Steps
- Higher precision for machine operation and processing quality
- Immediate refreshing of basic I/O ensures real-time processing
Faster response means higher precision and better quality
- High data memory capacity of up to 832 Kwords

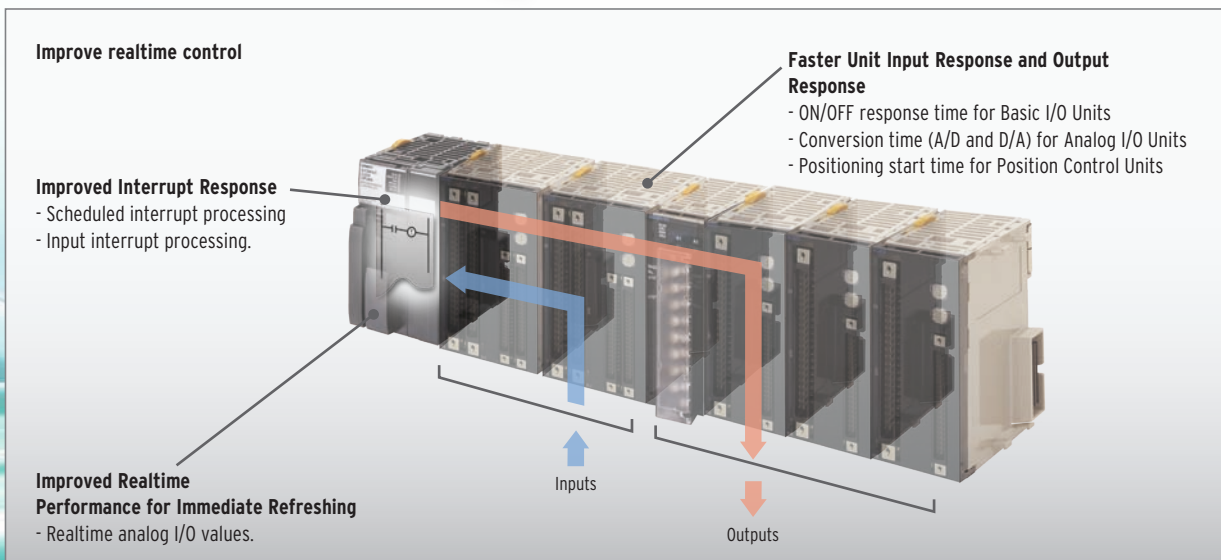

The CJ2 Provides a Complete Lineup

The complete lineup provides high-performance features from machine control to information processing.

Units		CJ2M		CJ2H	
Type		Simple Types	Standard Types	High - end Types	Flagship Types
Models		CJ2M-CPU1□	CJ2M-CPU3□	CJ2H-CPU6□	CJ2H-CPU6□-EIP
Appearance					
Program Capacity		Up to 60 Ksteps		Up to 400 Ksteps	
Data Memory Capacity		Up to 160 Kwords		Up to 832 Kwords	
I/O Bits		2,560			
Basic Instructions(LD)		40ns		16ns	
Special instruction (MOV)		120ns		48ns	
Floating-point decimal instructions (SIN)		0.86μs		0.59μs	
System overhead time		160μs	270μs	100μs	200μs
FB Program Area		YES (Equivalent to 20K steps.)		—	
Communications Port	USB Port	YES			
	Serial Port	YES (RS-232C)	One Serial Option Board can be mounted (RS-232C or RS-422A/485)	YES (RS-232C)	
	EtherNet/IP Port	—	YES	—	YES
Serial PLC Links		YES	YES (A Serial Option Board is required)	—	
High-speed Interrupt Function		—		YES	
Synchronous Unit Operation		—		YES (In combination with a CJ1W-NC□□4 Position Control Unit)	
Pulse I/O Modules*		YES (Up to two Pulse I/O Modules can be mounted)		—	

*A Pulse I/O Module must be mounted for CJ2M CPU Units with unit version 2.0 or later.

CJ2H

The Pursuit of High-speed Performance as a Controller

All processes that affect the cycle time have been made faster.

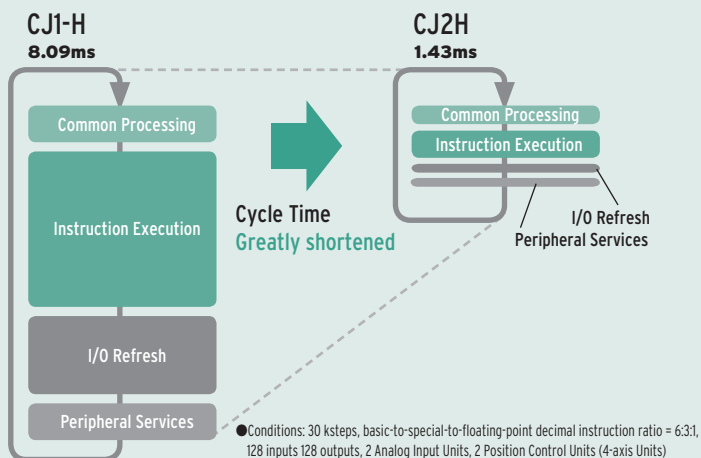

- Common Processing 300μs ▶ 100μs 3 times faster
- Instruction Execution LD 20ns ▶ 16ns 1.2 times faster
 SIN 42μs ▶ 0.59μs 71 times faster
- Refresh
- Basic I/O Unit: 3μs ▶ 1.4μs 2 times faster
- Immediate refreshing 20μs ▶ 1μs 20 times faster
- Interrupt Response
- Minimum Interval for Scheduled Interrupts 200μs ▶ 100μs 2 times faster
- Interrupt Response Time for Input Interrupts 30μs ▶ 17μs 1.8 times faster

Ample Instruction Execution Performance for Machine Control.

The CJ2 Series fully responds to customer requests for improved tact time and increased information.

System Overhead

- Common processing ▶ 100μs*
- Interrupt response ▶ 30μs

*CJ2H-CPU6□-EIP:200μs

Basic instructions

- LD instruction execution ▶ 16ns
- OUT instruction execution ▶ 16ns

Floating-point decimal instructions

- SIN calculation ▶ 0.59μs
- Floating-point decimal addition and subtraction ▶ 0.24μs

Faster Immediate I/O Refreshing

Realtime I/O during Instruction Execution

Immediate refreshing(ILD) ▶ 1μs **20 Times Faster**

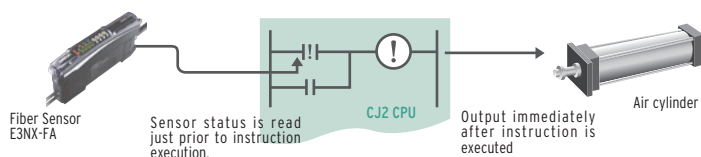

Improved Interrupt Response

For Finer Control

Faster Interrupt Response Time for Input Interrupts

[Immediate Execution at a Sensor Input]

Interrupt Response Time for Input Interrupts ▶ 17μs* **1.8 Times Faster**



CJ2H CPU Unit with unit version 1.1 or later is used.

Shorter Minimum Interval for Scheduled Interrupts

[Ideal for Processing at a Fixed Interval]

Minimum Interval for Scheduled Interrupts ▶ 100μs*1 **2 Times Faster** **Fastest in the Industry***2



CJ2H CPU Unit with unit version 1.1 or later is used.

* With the High-speed Interrupt Function

*1 Supported only for one scheduled interrupt task. The peripheral (USB) port or serial port of the CPU Unit can not be used at the same time.

*2 According to February 2010 OMRON survey in Japan.

Pulse I/O Modules expand the applicable positioning applications



Easily execute the position control of up to four axes

Either one or two Pulse I/O Modules can be connected to a CJ2M CPU Unit. The programming is as easy as pasting OMRON Function Blocks for positioning, or special instructions.

Pulse I/O Functions (for Two Pulse I/O Modules)

Input interrupts	8 points
High-speed counter inputs:	Single-phase, 100 kHz, 4 CHs or Phase-different input, 50 kHz, 4 CHs
Pulse outputs:	100 kHz, 4 axes or four PWM outputs

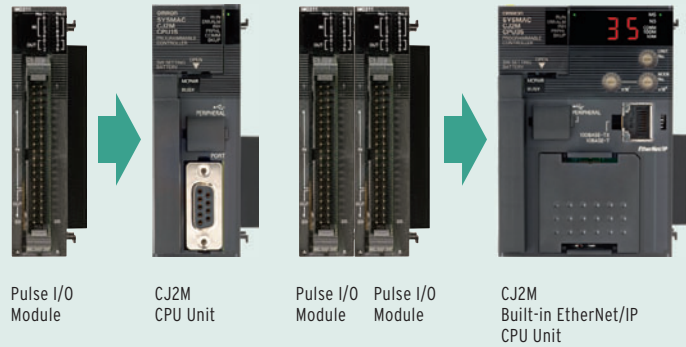

Note. A Pulse I/O Module must be mounted for CJ2M CPU Units with unit version 2.0 or later.

Input Interrupts

Up to eight interrupt inputs or quick-response inputs can be used.

- Pulse width as short as 30μs can be input with quick-response inputs.
- High-speed processing and interrupt response time of 33μs (in Direct Mode).
- Interrupts can be created for both of rising and falling edges.

High-speed Counters

Up to four high-speed counter inputs can be used by connecting rotary encoders to Pulse inputs.

- High-speed counting at 100 kHz for single-phase and 50 kHz for phase-different input.

High-speed Counter in Linear Mode

For applications such as conveyors.

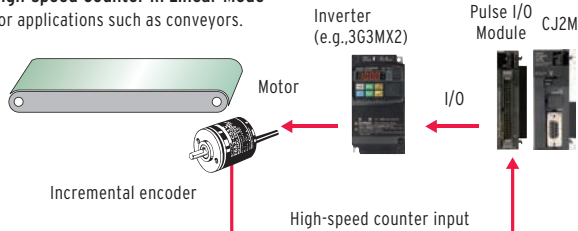

High-speed Counter in Ring Mode

For applications such as electronic component index tables.

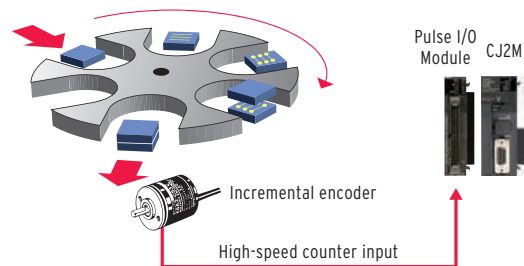

- The ring counter maximum value of a high-speed counter can be changed temporarily during operation.
- Start Interrupt Tasks using Target Value Comparison or Range Comparison for high-speed processing.
- The frequency (speed) can be easily measured by executing HIGH-SPEED COUNTER PV READ (PRV(881)) instruction. Ideal for applications such as measuring the speed of rotating bodies for inspections or detecting conveyor speeds. Can also be used for monitoring accumulated motor rotations.







Pulse Outputs

From stepping motors to servos, positioning control can be easily achieved using pulse outputs for up to four axes.

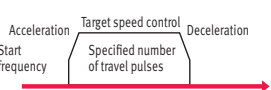
Faster and easier

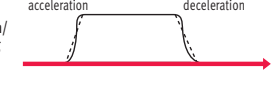
- Pulse control cycle of 1 ms (1/4 of OMRON's CJ1M). Achieve smoother acceleration and deceleration.
- Faster starting of position control (twice as fast as OMRON's CJ1M). Helps reduce machine takt time.
- INTERRUPT FEED instruction (IFEED(892)). Execute high-precision feeding from interrupt inputs with just one instruction.
- Close integration with the data trace function of the CX-Programmer for easy monitoring of positioning operations.

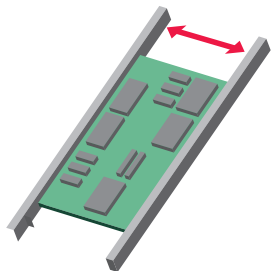
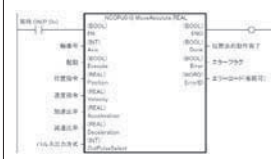
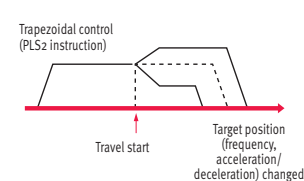
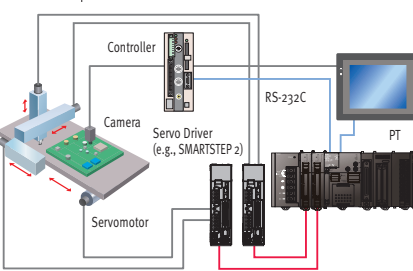
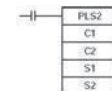
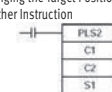
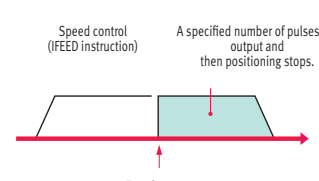
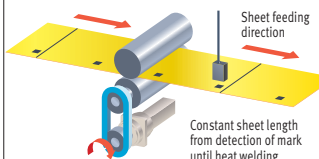
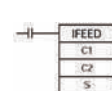
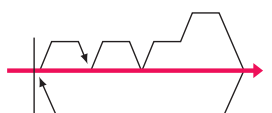
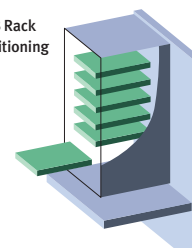
Complete positioning functions

Positioning control variations	Operation patterns	Application examples	Special instructions, OMRON Function Blocks
<p>Trapezoidal Acceleration/Deceleration Positioning</p> <p>Acceleration/deceleration time can be shortened with Trapezoidal Acceleration/Deceleration Positioning function and Triangular control. Detailed functions are provided for reducing out-of-step operation for stepping motors and eliminating error downtime.</p>	<p>•Basic Form</p>  <p>•Setting Acceleration and Deceleration Separately</p>  <p>•S-curve Acceleration/Deceleration Setting</p>  <p>•Triangular Control</p> 	<p>PCB Conveyor Rail Width Positioning</p> 	<p>Achieved with a single OMRON Function Blocks for specifying absolute (or relative) travel.</p> 
<p>Changing the Target Position during Positioning</p> <p>The target position can be changed during positioning. It is also possible to reverse direction when changing the target position.</p>	 	<p>Position Control Using Data Measured after Startup</p>	<p>While position control is being executed by a PLS2 instruction, another PLS2 instruction can be used to override the first PLS2 instruction.</p> <p>•Starting Trapezoidal Control</p>  <p>• Changing the Target Position with Another Instruction</p> 
<p>Interrupt Feeding</p> <p>It is possible to change to positioning control during speed control. Interrupt feeding can be executed after the interrupt for a specified number of pulses. Setting and starting interrupt feeding is possible with one instruction without using an interrupt task.</p>		<p>High-precision Interrupt for Positioning</p>  <p>Constant sheet length from detection of mark until heat welding.</p>	<p>Achieved with a single OMRON Function Block for interrupt feeding.</p> 
<p>Sequential Positioning</p> <p>Travel to multiple preset points can be executed. This is effective for applications such as positioning loaders and unloaders at multiple points.</p>		<p>PCB Rack Positioning</p> 	<p>Achieved with a single OMRON Function Block for specifying sequential positioning.</p> 

Flexible Machine Control with Refined I/O Perform

Improve realtime control.

CJ2H

CJ2M

Improved Realtime Performance for Immediate Refreshing

Direct Processing with analog I/O

Faster Unit Input Response and Output Response

Basic I/O Units, Position Control Units, Analog I/O Units, Serial Communication Units

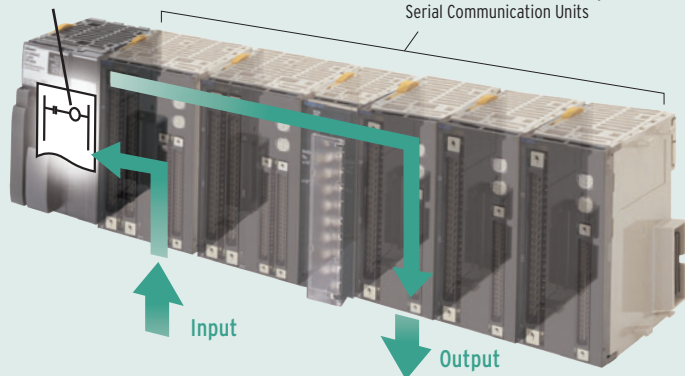

In addition to the greater processing performance of the CPU Unit, OMRON has also improved the response performance of each Unit. Faster throughput from inputs and processing to outputs helps to improve equipment tact time and work processing quality.

Faster Unit I/O Response

Lineup of High-speed Units

Faster ON/OFF response time

[Improved Basic Response]

ON response time ▶ 15 μs

1.3 Times Faster

OFF response time ▶ 90 μs

4 Times Faster



Basic I/O Units:
High-speed type
CJ1W-ID212
ID233

High-speed Positioning

[High-speed All the Way to Pulse Output]

Positioning start time ▶ 0.1 ms*

20 Times Faster



Position Control Units:
High-speed type
CJ1W-NC□□4

* Starting time for first axis when all axes are stopped.

High-speed Analog I/O

[Improved Basic Response]

A/D, D/A conversion period ▶ 20 μs / 1 point
~ to 35 μs / 4 point

12 Times Faster

Fastest in the Industry*



Analog Input/Output Unit:
High-speed type
CJ1W-AD042
CJ1W-DA042V

* According to February 2010 OMRON survey in Japan.

High-speed Serial Communications (No-protocol)

[Data Reception in Microseconds]

Consistent high speed is achieved from data reception to storage in CPU Unit memory. ▶ 210 μs*

162 Times Faster



Continuous reception is possible on a high-speed cycle. ▶ 800 μs*

42 Times Faster

Serial Communication Unit:
High-speed type
CJ1W-SCU□2

Baud rate ▶ 230 kbps

* CJ2H CPU Unit with unit version 1.1 or later is used. 230kbps,10bytes,The DRXDU instruction is used in an interrupt task.

Direct Processing with Enhanced Immediate Refreshing

Analog Input and Output with no jitter

Consistency is achieved from input to processing and output with direct conversion functions for High-speed Units.*

* The analog-digital or digital-analog conversion and refreshing of converted values and set values are performed when the Direct Conversion Instruction (AIDC/APDC) is executed. Supported only by the CJ2H CPU Units with unit version 1.1 or later and CJ2M CPU Units.

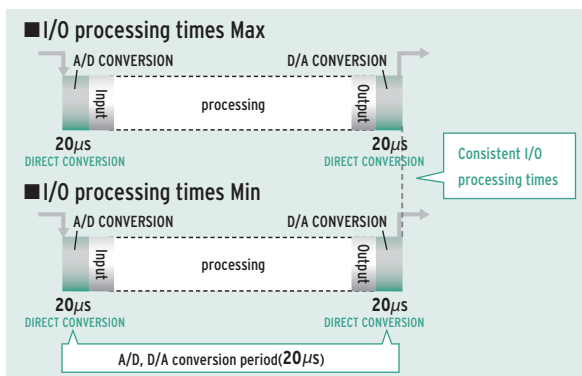

EtherNet/IP Is User Friendly in Three Ways

An open industrial network that implements a control protocol on general-purpose Ethernet technology.

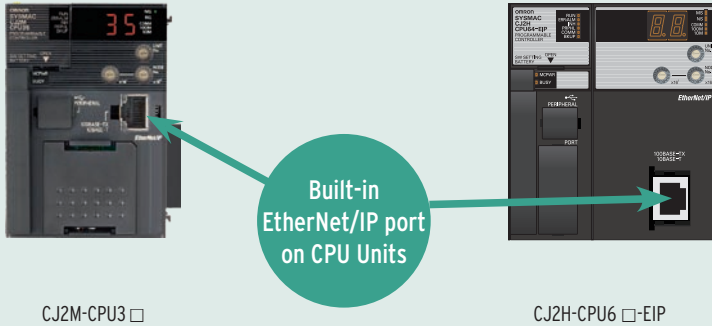

CJ2 CPU Units are available with multifunctional Ethernet ports that are compatible with EtherNet/IP. Peripheral Devices for universal Ethernet Technology (such as Cables, Hubs, and Wireless Devices) can be used with CJ2 CPU Units. Reduces network installation and wiring costs.



Multiple functions can be executed simultaneously on one port.



Support Software, Data Links, Message communications between PLCs, FTP Communications

The port connection does not need to be changed, which makes it easier to build the system.

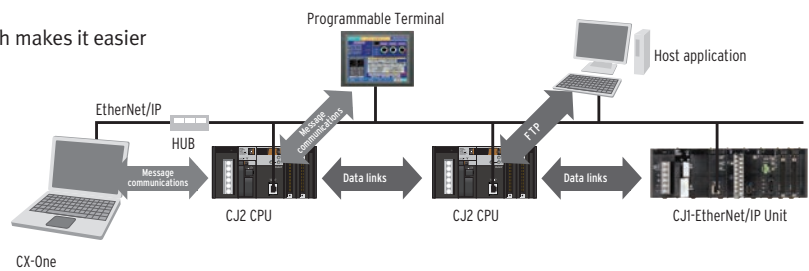

Extremely Fast and High-capacity Data Links



Large Data Transfers with High Reliability

From manufacturing recipes and information on interlocks between processes to production data, any type of data can be exchanged at high speed and at the optimal timing. Communications performance is vastly improved over OMRON's Controller Link and FL-net networks.

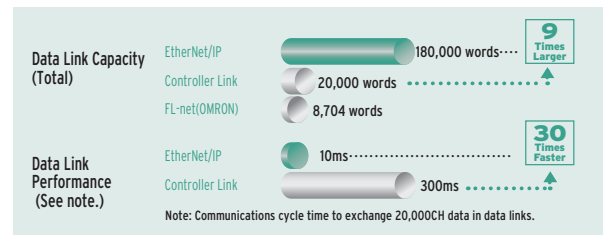

Using the CJ2H built-in EtherNet/IP port (Functionality differs when using the CJ2M built-in EtherNet/IP port)

Efficient Programming with Tag Symbols



There Is Little Effect on Address Changes.

Previously, when data was exchanged by specifying address and addresses were changed, the program had to be changed at other Controllers and various operations, such as memory checks, had to be performed. Now, tag names reduce the dependence on a memory map and the need for checking items affected by changes. This allows equipment to be easily added or upgraded.

CJ2H-CPU6 □ -EIP: 20,000 max., CJ2M-CPU3 □ : 2,000 max.

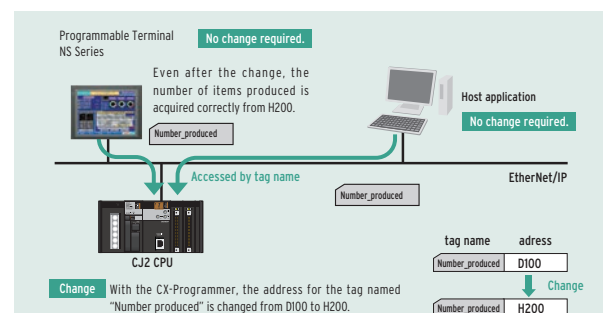

Network Solutions for Control Automation Technology

Simplified system on the integration of network

Expanding applications, not limited for motion control.
Flexible communication specification allows a wide variety of devices to join the same network. The connectable devices involve drive devices such as Servo Drives and Inverters, I/O devices, and other intelligent devices, including Vision Sensors.

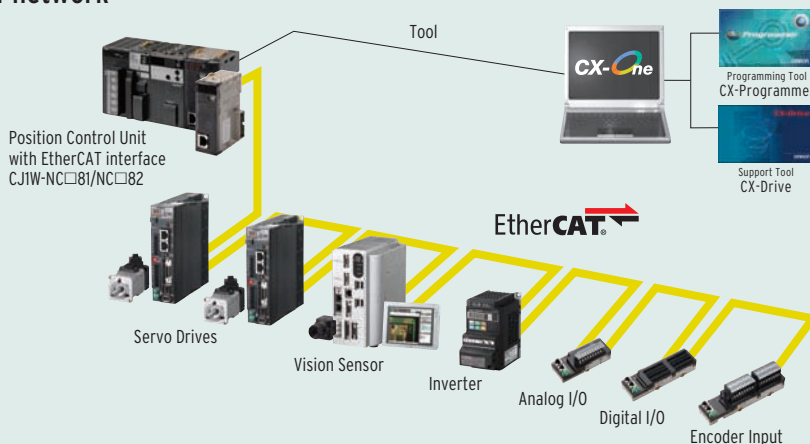

You Get Both the Easy Startup of Networks and the High-speed Starting



Superior Performance and Easy Operation

100Mbps

[High-speed communications]

With EtherCAT, you can improve the performance of overall system from PLCs to servo system, as well as stand-alone Servo performance.

0.4ms (when starting 4 axes)

[High-speed starting]

High-speed starting and control performance equivalent to those of pulse-train systems are achieved through network connections.

Starting time ► **0.4 ms** 5 Times Faster Control cycle ► **0.5 ms** 4 Times Faster

* A CJ2H CPU Unit with unit version 1.3 or higher or a CJ2M CPU Unit is required.

1 connection

[Simple wiring]

EtherCAT devices can be easily connected with Ethernet cables, which reduces wiring works.

1 port

[Simple startup]

Without reconnecting the computer, you can configure both the Position Control Units and EtherCAT communications setting via CPU unit. You can also directly connect the CX-Drive to set the Servo Drives.

Share the Same Programming



Common programming enables easy introduction into existing systems

The Position Control Units with EtherCAT interface use the same positioning functions* as High-speed Pulse-train Position Control Units, and the programming interface is also the same. You can easily switch the unit type between the Position Control Units depending on the application.

* Except Synchronized control function.

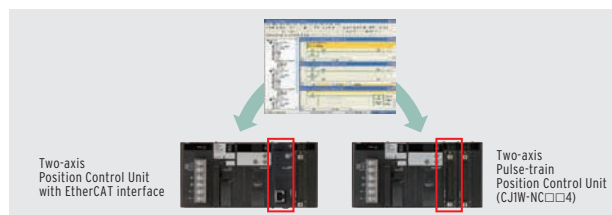

Achieve High-speed, Low-cost Synchronized Multi-axis Control with Pulse Outputs (CJ1W-NC□□4)



Building Synchronized Systems Using Only Ladder Programming and No Special Controllers

Synchronous unit operation between Special I/O Units and the CPU Unit ensures concurrency from input to processing and output. A consistent, high-speed synchronous control cycle of 1 ms makes it easy to ensure application performance.

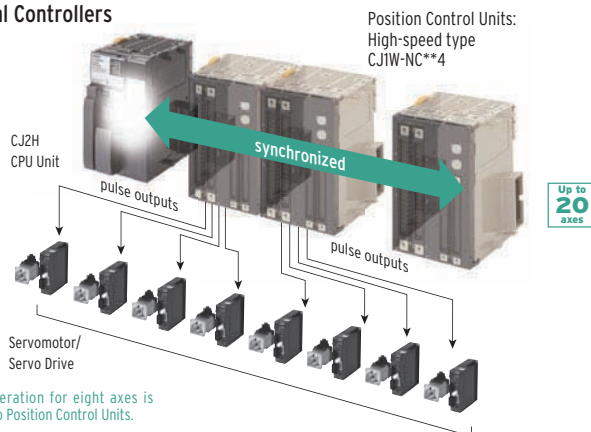
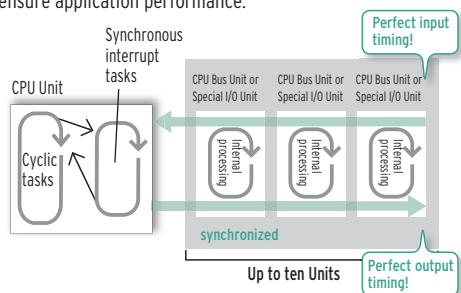

Supported only by the CJ2H CPU Units with unit version 1.1 or later.

Note: EtherCAT® is a registered trademark and patented technology, licensed by Beckhoff Automation GmbH, Germany.



More Flexible Programming, Easier Debugging

Changes to specifications can be handled easily and total lead time is reduced for system startup and troubleshooting.

A Smart Input Function greatly reduces the work required to input programs 50%* Reduced

Easy, Intuitive Programming Software

A complete range of intuitive programming functions is provided, including instruction and address input assistance, address incrementing, and address incremental copy. These functions enable waste-free programming with minimal effort.

* In comparison to CX-Programmer version 8.

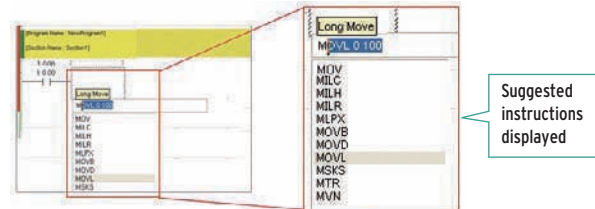

Highly Readable Programming

The Greatest Program Diversity in the Industry.

- Bit Addresses can be used in the DM Area and EM Area.
- BCD and Binary Timer instructions can be used Together.
- Function blocks make units of processing easy to understand.
- Function block definitions do not take up user program memory capacity.*

- Address offsets can be specified
- Array variables are supported, A symbol can be used for an array variable subscript.
- Structure symbols* make it easier to create data structures and data bases.

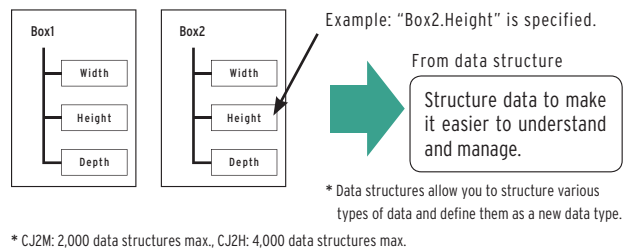
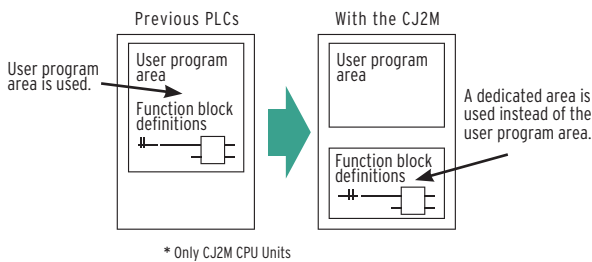

Stress-free Online Debugging

Effects on Machinery Operation Are Reduced.

- The additional cycle time due to online editing has been reduced to approx. 1 ms
- Unlimited ST and SFC online editing

Greatly Improved Debugging Efficiency Through Superior Data Tracing

High-speed, High-capacity Data Tracing Is Now Possible.

Ample Trigger Conditions

One, two, or four words of data and comparison conditions can be specified. For example, a trigger can be set for when double-precision data is larger than a specified value.

High-capacity Data Tracing

Maximum 32 Kwords (CJ2H) of data can be traced, and the EM Area can also be used as trace memory.

CX-One Data Trace Is Also Upgraded.

- The improved CJ2 trace function is fully utilized.
- A function has been added for superimposing trace waveforms
- Trace results can be printed or saved as bit maps.
- The measurement times for two selected points can be checked.

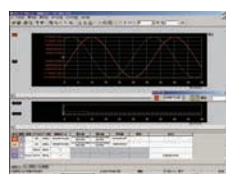

Data Trace

Continuous Data Tracing

Sampled data in the trace memory of the CPU Unit can be regularly collected at the personal computer to enable sampling for long periods or time. Data can be saved in the CSV files in personal computer.

Ideal for Applications Requiring High Speed, Synchronization, and Multiple Axes Helps Improve Machine I/O Throughput

Tension Control

Inconsistencies in I/O processing times are eliminated to reduce takt times.

Use High-speed Analog I/O Units

CJ2M

CJ2H

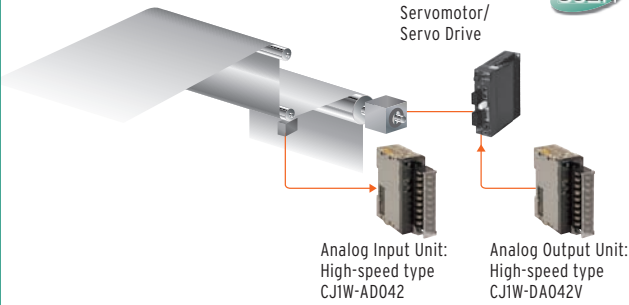

Direct conversion enables faster input of analog values into the CJ2 CPU Unit.

Inline Measurement

Analog quantities are input in ultra-high speed (20μs) to improve the accuracy of NG product detection.

Use High-speed Analog I/O Units

CJ2M

CJ2H

Analog Input Unit:
High-speed type
CJ1W-AD042

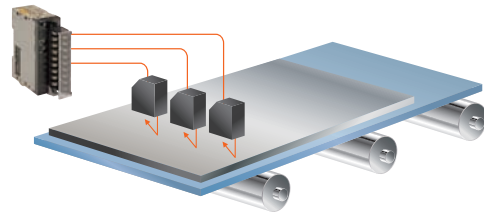

High-speed Serial Input from Laser Distance Meters

Achieve high-speed data input from high-speed measurement sensors, such as laser distance meters and displacement sensors.

Use High-speed Serial Communications Units

CJ2M

CJ2H

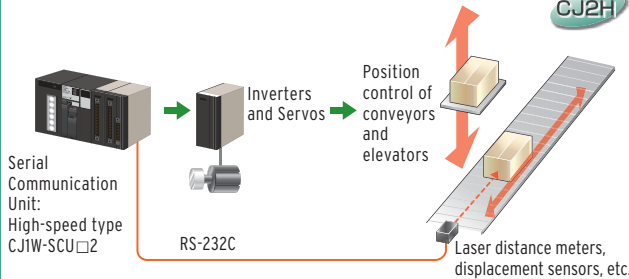

Transfer position data to the CPU Unit from laser distance meters with short measurement cycles without missing data to achieve precise control of inverters for conveyors and elevators.

High-speed Serial Input from Barcode Readers

High-speed Sorting Control Using a Barcode Reader

Use High-speed Serial Communications Units

CJ2M

CJ2H

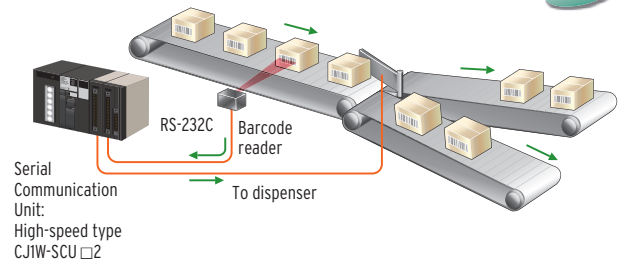

Data from the barcode reader is transferred quickly to the CPU Unit to recognize the code and output pulses at high speed.

Synchronized Control

An electronic cam enables high-precision synchronized control.

Use CJ2H CPU Unit and Position Control Unit

CJ2H

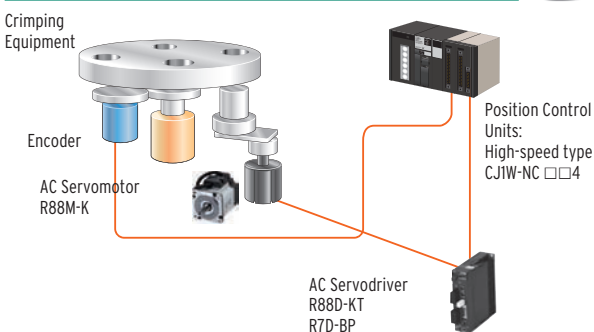

Multi-axis Position Control through EtherCAT

Reduce Production Takt Time with High-speed Startup at 0.4 ms.

Use CJ2 CPU Unit and Position Control Unit with EtherCAT interface

CJ2M

CJ2H

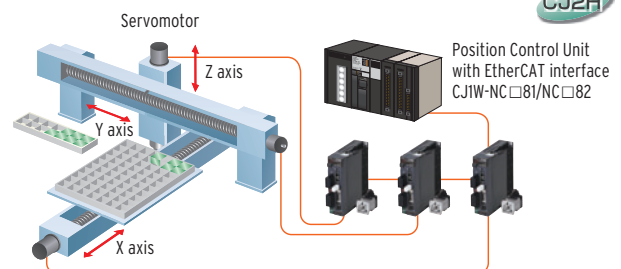

Palletizing: A starting time of 0.4 ms helps reduce the takt time of applications that perform repeated positioning.

System Design Guide

System Configuration	2
Checking Current Consumption and Power Consumption	10
Dimensions	11
General Specifications	14
Performance Specifications	15
Function Specifications	19
Specifications for Pulse I/O Functions	24

System Configuration

Basic System

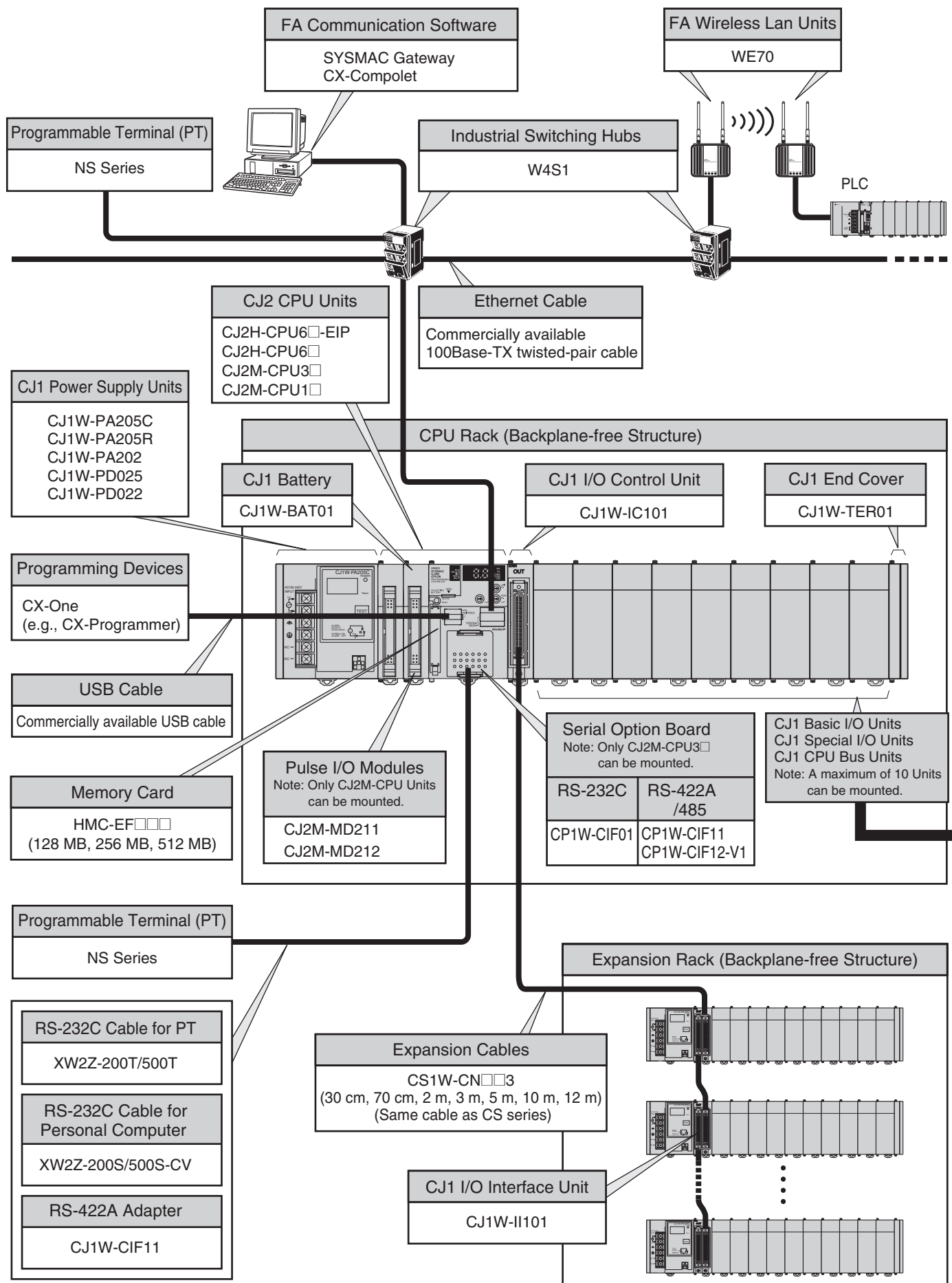

■ Configuration Units

CJ1 Basic I/O Units			
8-point Units	16-point Units	32-point Units	64-point Units
Input Units			
<ul style="list-style-type: none"> ● DC Input Unit CJ1W-ID201 ● AC Input Unit CJ1W-IA201 	<ul style="list-style-type: none"> ● DC Input Unit CJ1W-ID211 CJ1W-ID212 High-speed type ● AC Input Unit CJ1W-IA111 	<ul style="list-style-type: none"> ● DC Input Unit CJ1W-ID231 CJ1W-ID232 CJ1W-ID233 High-speed type 	<ul style="list-style-type: none"> ● DC Input Unit CJ1W-ID261 CJ1W-ID262
Output Units			
<ul style="list-style-type: none"> ● Relay Contact Output Unit (independent commons) CJ1W-OC201 ● Triac Output Unit CJ1W-OA201 ● Transistor Output Units CJ1W-OD201 CJ1W-OD203 CJ1W-OD202 CJ1W-OD204 	<ul style="list-style-type: none"> ● Relay Contact Output Unit CJ1W-OC211 ● Transistor Output Units CJ1W-OD211 CJ1W-OD213 High-speed type CJ1W-OD212 	<ul style="list-style-type: none"> ● Transistor Output Units CJ1W-OD231 CJ1W-OD233 CJ1W-OD234 High-speed type CJ1W-OD232 	<ul style="list-style-type: none"> ● Transistor Output Units CJ1W-OD261 CJ1W-OD263 CJ1W-OD262
I/O Units			
---	---	(16 inputs, 16 outputs) ● DC Input/Transistor Output Units CJ1W-MD231 CJ1W-MD233 CJ1W-MD232	32 inputs, 32 outputs ● DC Input/Transistor Output Units CJ1W-MD261 CJ1W-MD263 32 inputs, 32 outputs ● TTL I/O Unit CJ1W-MD563
Other Units			
---	<ul style="list-style-type: none"> ● Interrupt Input Unit CJ1W-INT01 ● Quick-response Input Unit CJ1W-IDP01 	---	<ul style="list-style-type: none"> ● B7A Interface Units (64 inputs) CJ1W-B7A14 (64 outputs) CJ1W-B7A04 (32 inputs, 32 outputs) CJ1W-B7A22

CJ1 Special I/O Units and CPU Bus Units			
<ul style="list-style-type: none"> ■ Process I/O Units ● Isolated-type Units with Universal Inputs CJ1W-PH41U CJ1W-AD04U ● Isolated-type Thermocouple Input Units CJ1W-PTS15 CJ1W-PTS51 ● Isolated-type Resistance Thermometer Input Units CJ1W-PTS16 CJ1W-PTS52 ● Isolated-type DC Input Unit CJ1W-PDC15 ■ Analog I/O Units ● Analog Input Units CJ1W-AD042 High-speed type CJ1W-AD081-V1 CJ1W-AD041-V1 ● Analog Output Units CJ1W-DA042V High-speed type CJ1W-DA08V CJ1W-DA08C CJ1W-DA041 CJ1W-DA021 ● Analog I/O Units CJ1W-MAD42 ■ Temperature Control Units CJ1W-TC001, CJ1W-TC002 CJ1W-TC003, CJ1W-TC004 CJ1W-TC101, CJ1W-TC102 CJ1W-TC103, CJ1W-TC104 	<ul style="list-style-type: none"> ■ High-speed Counter Units CJ1W-CT021 ■ Position Control Units CJ1W-NC214 High-speed type CJ1W-NC414 High-speed type CJ1W-NC234 High-speed type CJ1W-NC434 High-speed type CJ1W-NC113 CJ1W-NC213 CJ1W-NC413 CJ1W-NC133 CJ1W-NC233 CJ1W-NC433 ■ Position Control Unit with EtherCAT interface CJ1W-NC281 CJ1W-NC481 CJ1W-NC881 CJ1W-NCF81 CJ1W-NC482 CJ1W-NC882 CJ1W-NCF82 ■ Position Control Unit with MECHATROLINK-II interface CJ1W-NC271 CJ1W-NC471 CJ1W-NCF71 CJ1W-NCF71-MA ■ Motion Control Unit with MECHATROLINK-II interface CJ1W-MCH71 	<ul style="list-style-type: none"> ■ Serial Communications Units CJ1W-SCU22 High-speed type CJ1W-SCU32 High-speed type CJ1W-SCU42 High-speed type CJ1W-SCU21-V1 CJ1W-SCU31-V1 CJ1W-SCU41-V1 ■ EtherNet/IP Unit CJ1W-EIP21 ■ Ethernet Unit CJ1W-ETN21 ■ Controller Link Units CJ1W-CLK23 ■ FL-net Unit CJ1W-FLN22 ■ DeviceNet Unit CJ1W-DRM21 ■ CompoNet Master Unit CJ1W-CRM21 ■ CompoBus/S Master Unit CJ1W-SRM21 ■ EtherCAT Slave Unit CJ1W-ECT21 	<ul style="list-style-type: none"> ■ ID Sensor Units CJ1W-V680C11 CJ1W-V680C12 CJ1W-V600C11 CJ1W-V600C12 ■ High-speed Data Storage Unit CJ1W-SPU01-V2

Note 1. Microsoft, Visual Basic, Visual C#, Visual Studio and Windows are either registered trademarks or trademarks of Microsoft Corporation in the United States and/or other countries. Microsoft product screen shot(s) reprinted with permission from Microsoft Corporation.
 EtherCAT® is registered trademark and patented technology, licensed by Beckhoff Automation GmbH, Germany.
 EtherNet/IP™, DeviceNet™ and CompoNet™ are trademarks of the ODVA.
 Other company names and product names in this document are the trademarks or registered trademarks of their respective companies.

2. Including models whose production are discontinued.

■ CJ-series CPU Racks

A CJ-series CPU Rack consists of a CPU Unit, Power Supply Unit, Configuration Units (Basic I/O Units, Special I/O Units, and CPU Bus Units), and an End Cover.

CJ2H CPU Units

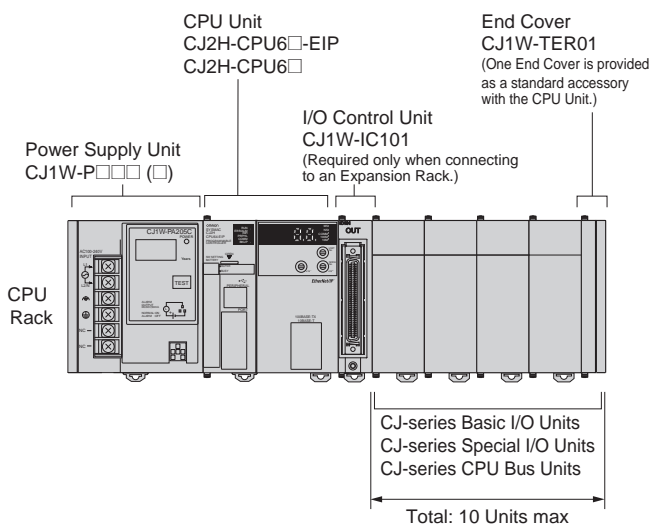

CJ2M CPU Units

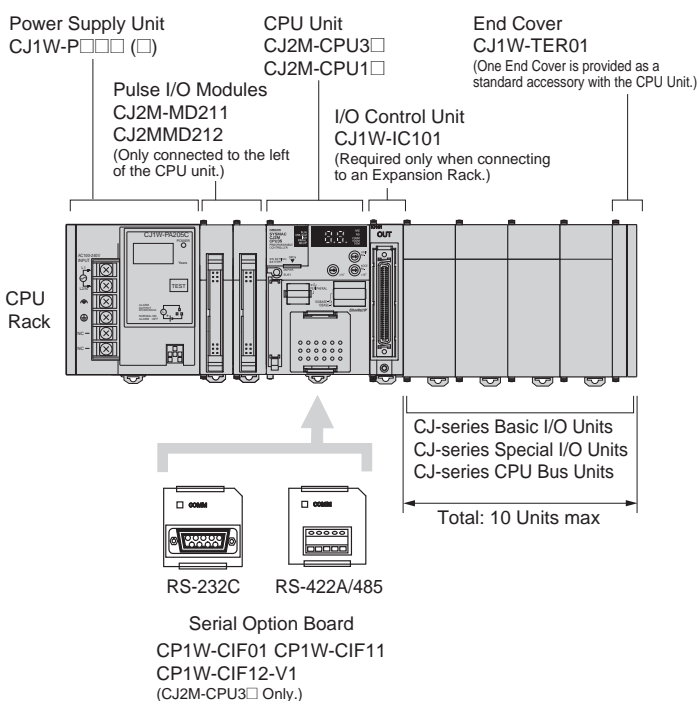

● Required Units

Rack	Unit name	Required number of Units
CPU Rack	Power Supply Unit	1
	CPU Unit	1
	Pulse I/O Modules	Required only for using Pulse I/O. Up to two Pulse I/O Modules can be connected to a CJ2M CPU Unit. They must be connected immediately to the left of the CPU Unit.
	Serial Option Board	One Serial Option Board can be mounted in the CJ2M-CPU3□.
	I/O Control Unit	Required only for mounting to an Expansion Rack. Mount the I/O Control Unit immediately to the right of the CPU Unit.
	Number of Configuration Units	10 max. (Same for all models of CPU Unit.) (The number of Basic I/O Units, Special I/O Units, and CPU Bus Units can be varied. The number does not include the I/O Control Unit.)
	End Cover	1 (Included with CPU Unit.)

● Types of Units

In the CJ Series, Units are classified into the following three types. The number of Racks differs depending on the type.

Type	Appearance (example)	Description	Unit recognition method	Max. Units mountable per CPU Unit
Basic I/O Units		Units with contact inputs and contact outputs.	Recognized by the CPU Unit according to the position of the Rack and slot.	A maximum of 40 Units can be mounted.
Special I/O Units		Special I/O Units provide more advanced functions than do Basic I/O Units, including I/O other than contact inputs and contact outputs. Examples of Special I/O Units are Analog I/O Units and High-speed Counter Units. They differ from CPU Bus Units (including Network Communications Units) in having a smaller area for exchanging data with the CPU Unit.	Recognized by the CPU Unit according to the unit number (0 to 95) set with the rotary switches on the front panel.	A maximum of 40 Units can be connected. (Multiple unit numbers are allocated per Unit, depending on the model and settings.)
CPU Bus Units		CPU Bus Units exchange data with the CPU Unit via the CPU Bus. Examples of CPU Bus Units are Network Communications Units and Serial Communications Units. They differ from Special I/O Units in having a larger area for exchanging data with the CPU Unit.	Recognized by the CPU Unit according to the unit number (0 to F) set with the rotary switch on the front panel.	A maximum of 16 Units can be mounted.

■ CJ-series Expansion Racks

A CJ-series Expansion Rack consists of a Power Supply Unit, an I/O Interface Unit, Configuration Units (Basic I/O Units, Special I/O Units, and CPU Bus Units), and an End Cover.

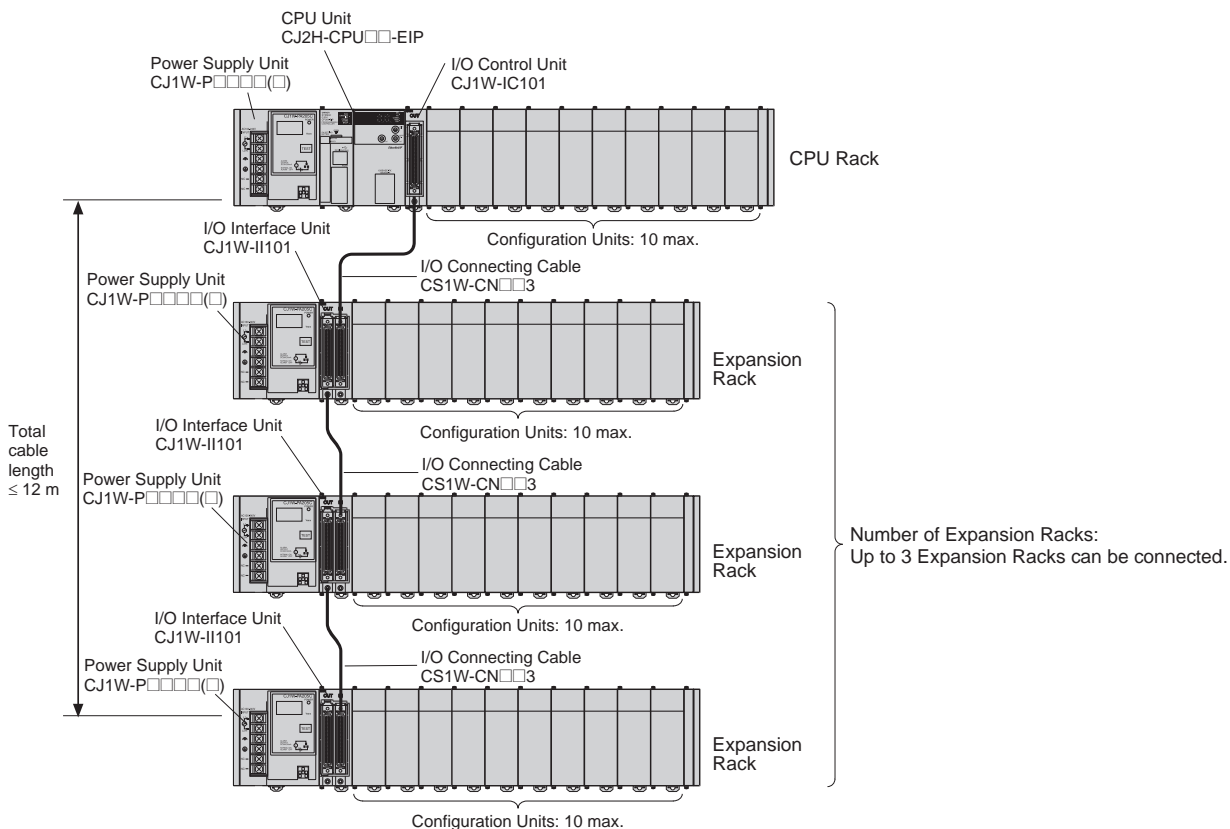

● Required Units

Rack	Unit name	Required number of Units
CPU Rack	I/O Control Unit	One Unit. Required only when an Expansion Rack is used. Mount the I/O Control Unit immediately to the right of the CPU Unit. (See note 1.)
Expansion Rack	Power Supply Unit	One Unit
	I/O Interface Unit	One Unit. Mount the I/O Interface Unit immediately to the right of the Power Supply Unit. (See note 2.)
	Number of Configuration Units	Ten Units max. (The number of Basic I/O Units, Special I/O Units, and CPU Bus Units can be varied. This number does not include the I/O Interface Unit.)
	End Cover	One (Included with the I/O Interface Unit.)

- Note 1.** Mounting the I/O Control Unit in any other location may cause faulty operation.
Note 2. Mounting the I/O Interface Unit in any other location may cause faulty operation.

● Maximum Number of Configuration Units That Can Be Mounted

CPU Unit	Model	Total Units	No. of Units on CPU Rack	No. of Expansion Racks
CJ2H	CJ2H-CPU68 (-EIP)	40	10 per Rack	3 Racks x 10 Units
	CJ2H-CPU67 (-EIP)			
	CJ2H-CPU66 (-EIP)			
	CJ2H-CPU65 (-EIP)			
	CJ2H-CPU64 (-EIP)			
CJ2M	CJ2M-CPU35	40	10 per Rack	3 Racks x 10 Units
	CJ2M-CPU34			
	CJ2M-CPU33			
	CJ2M-CPU32			
	CJ2M-CPU31			
	CJ2M-CPU15			
	CJ2M-CPU14			
	CJ2M-CPU13			
	CJ2M-CPU12			
CJ2M-CPU11				

Note: It may not be possible to mount the maximum number of configuration Units depending on the specific Units that are mounted. Refer to the next page for details.

● Configuration Units

CJ-series Special I/O Units

Type	Name	Specifications	Model	Number of words allocated (CIO 2000 to CIO 2959)	Number of words allocated (D20000 to D29599)	Unit No.	Number of mountable Units	Current consumption (A)		Weight
								5 VDC	24 VDC	
Special I/O Units	General-purpose Universal Analog Input Unit	4 inputs, fully universal	CJ1W-AD04U	10 words	100 words	0 to 95	40 Units	0.32	---	150 g max.
	Analog Input Units	8 inputs (4 to 20 mA, 1 to 5 V, etc.)	CJ1W-AD081-V1	10 words	100 words	0 to 95	40 Units	0.42	---	140 g max.
		4 inputs (4 to 20 mA, 1 to 5 V, etc.)	CJ1W-AD041-V1	10 words	100 words	0 to 95	40 Units	0.42	---	140 g max.
		4 inputs (4 to 20 mA, 1 to 5 V, etc.)	CJ1W-AD042	10 words	100 words	0 to 95	40 Units	0.52	---	150 g max.
	Analog Output Units	4 outputs (1 to 5 V, 4 to 20 mA, etc.)	CJ1W-DA041	10 words	100 words	0 to 95	40 Units	0.12	---	150 g max.
		2 outputs (1 to 5 V, 4 to 20 mA, etc.)	CJ1W-DA021	10 words	100 words	0 to 95	40 Units	0.12	---	150 g max.
		8 outputs (1 to 5 V, 0 to 10 V, etc.)	CJ1W-DA08V	10 words	100 words	0 to 95	40 Units	0.14	---	150 g max.
		8 outputs (4 to 20 mA)	CJ1W-DA08C	10 words	100 words	0 to 95	40 Units	0.14	---	150 g max.
		4 outputs (1 to 5 V, 0 to 10 V, etc.)	CJ1W-DA042V	10 words	100 words	0 to 95	40 Units	0.40	---	150 g max.
	Analog I/O Unit	4 inputs (1 to 5 V, 4 to 20 mA, etc.) 2 outputs (1 to 5 V, 4 to 20 mA, etc.)	CJ1W-MAD42	10 words	100 words	0 to 95	40 Units	0.58	---	150 g max.
	Isolated-type High-resolution Universal Input Unit	4 inputs, fully universal Resolution: 1/256,000, 1/64,000, 1/16,000	CJ1W-PH41U	10 words	100 words	0 to 95	40 Units	0.30	---	150 g max.
	Isolated-type Thermocouple Input Units	4 thermocouple inputs	CJ1W-PTS51	10 words	100 words	0 to 95	40 Units	0.25	---	150 g max.
		2 thermocouple inputs	CJ1W-PTS15	10 words	100 words	0 to 95	40 Units	0.18	---	150 g max.
	Isolated-type Resistance Thermometer Input Units	4 resistance thermometer inputs	CJ1W-PTS52	10 words	100 words	0 to 95	40 Units	0.25	---	150 g max.
		2 resistance thermometer inputs	CJ1W-PTS16	10 words	100 words	0 to 95	40 Units	0.18	---	150 g max.
	Direct Current Input Unit	DC voltage or DC current, 2 inputs	CJ1W-PDC15	10 words	100 words	0 to 95	40 Units	0.18	---	150 g max.
	Temperature Control Units	4 control loops, thermocouple inputs, NPN outputs	CJ1W-TC001	20 words	200 words	0 to 94 (uses words for 2 unit numbers)	40 Units	0.25	---	150 g max.
		4 control loops, thermocouple inputs, PNP outputs	CJ1W-TC002	20 words	200 words	0 to 94 (uses words for 2 unit numbers)	40 Units	0.25	---	150 g max.
		2 control loops, thermocouple inputs, NPN outputs, heater burnout detection	CJ1W-TC003	20 words	200 words	0 to 94 (uses words for 2 unit numbers)	40 Units	0.25	---	150 g max.
		2 control loops, thermocouple inputs, PNP outputs, heater burnout detection	CJ1W-TC004	20 words	200 words	0 to 94 (uses words for 2 unit numbers)	40 Units	0.25	---	150 g max.
4 control loops, temperature- resistance thermometer inputs, NPN outputs		CJ1W-TC101	20 words	200 words	0 to 94 (uses words for 2 unit numbers)	40 Units	0.25	---	150 g max.	
4 control loops, temperature- resistance thermometer inputs, PNP outputs		CJ1W-TC102	20 words	200 words	0 to 94 (uses words for 2 unit numbers)	40 Units	0.25	---	150 g max.	
2 control loops, temperature-resistance thermometer inputs, NPN outputs, heater burnout detection		CJ1W-TC103	20 words	200 words	0 to 94 (uses words for 2 unit numbers)	40 Units	0.25	---	150 g max.	
2 control loops, temperature-resistance thermometer inputs, PNP outputs, heater burnout detection		CJ1W-TC104	20 words	200 words	0 to 94 (uses words for 2 unit numbers)	40 Units	0.25	---	150 g max.	

Note: Including models whose production are discontinued.

Type	Name	Specifications	Model	Number of words allocated (CIO 2000 to CIO 2959)	Number of words allocated (D20000 to D29599)	Unit No.	Number of mountable Units	Current consumption (A)		Weight
								5 VDC	24 VDC	
Special I/O Units	Position Control Units	1 axis, pulse output; open collector output	CJ1W-NC113	10 words	100 words	0 to 95	40 Units	0.25	---	100 g max.
		2 axes, pulse outputs; open collector outputs	CJ1W-NC213	10 words	100 words	0 to 95	40 Units	0.25	---	100 g max.
			CJ1W-NC214 *1, *2	18 words *3	None	0 to 94 (uses words for 2 unit numbers)	5 Units/Rack	0.27	---	170 g max.
		4 axes, pulse outputs; open collector outputs	CJ1W-NC413	20 words	200 words	0 to 94 (uses words for 2 unit numbers)	40 Units	0.36	---	150 g max.
			CJ1W-NC414 *1, *2	18 words *3	None	0 to 94 (uses words for 2 unit numbers)	5 Units/Rack	0.31	---	220 g max.
		1 axis, pulse output; line driver output	CJ1W-NC133	10 words	100 words	0 to 95	40 Units	0.25	---	100 g max.
		2 axes, pulse outputs; line driver outputs	CJ1W-NC233	10 words	100 words	0 to 95	40 Units	0.25	---	100 g max.
			CJ1W-NC234 *1, *2	18 words *3	None	0 to 94 (uses words for 2 unit numbers)	5 Units/Rack	0.27	---	170 g max.
		4 axes, pulse outputs; line driver outputs	CJ1W-NC433	20 words	200 words	0 to 94 (uses words for 2 unit numbers)	40 Units	0.36	---	150 g max.
	CJ1W-NC434 *1, *2		18 words *3	None	0 to 94 (uses words for 2 unit numbers)	5 Units/Rack	0.31	---	220 g max.	
	Space Unit *4	CJ1W-SP001	None	None	---	---	---	---	50 g max.	
	ID Sensor Units	V600-series single-head type	CJ1W-V600C11	10 words	100 words	0 to 95	40 Units	0.26	0.12	120 g max.
		V600-series two-head type	CJ1W-V600C12	20 words	200 words	0 to 94 (uses words for 2 unit numbers)	40 Units	0.32	0.24	130 g max.
		V680-series single-head type	CJ1W-V680C11	10 words	100 words	0 to 95	40 Units	0.26	0.13	120 g max.
		V680-series two-head type	CJ1W-V680C12	20 words	200 words	0 to 94 (uses words for 2 unit numbers)	40 Units	0.32	0.26	130 g max.
High-speed Counter Unit	Number of counter channels: 2, Maximum input frequency: 500 kHz, line driver compatible *5	CJ1W-CT021 *7	40 words	400 words	0 to 92 (uses words for 4 unit numbers)	24 Units	0.28	---	100 g max.	
CompoBus/S Master Units	CompoBus/S remote I/O, 256 bits max.	CJ1W-SRM21	10 words or 20 words	None	0 to 95 or 0 to 94	40 Units	0.15	---	66 g max. *6	

- *1. With a CJ2 CPU Unit, up to 10 Configuration Units can be connected in the CPU Rack and in each Expansion Rack. The CJ1W-NC□□4, however, must be counted as two Units. Configure the Units to satisfy the following formula.
Number of CJ1W-NC□□4 Units × 2 + Number of other Units ≤ 10
For example, if five CJ1W-NC□□4 Units are connected to one Rack, no other Units can be connected.
- *2. The Units must be mounted on the CPU Rack to use synchronous unit operation.
- *3. In addition to the words allocated in the Special I/O Unit Area, up to 144 words are allocated according to the number of axes and functions uses. Word allocations are set using the CX-Programmer.
- *4. The Space Unit is for Position Control Units.
- *5. If interrupts to the CPU Unit are used, mount the Interrupt Input Unit in one of the following slots on the CPU Rack.
 - CJ2H-CPU6□-EIP: Slots 0 to 3
 - CJ2H-CPU6□ or CJ2M-CPU□□: Slots 0 to 4
- *6. Includes the weight of accessory connectors.
- *7. Use Lot No. 030121 or later (Unit Version 1.06) of CJ1W-CT021 when using with CJ2 CPU Units.

Type	Name	Specifications	Model	Number of words allocated (CIO 2000 to CIO 2959)	Number of words allocated (D20000 to D29599)	Unit No.	Number of mountable Units	Current consumption (A)		Weight
								5 VDC	24 VDC	
Special I/O Units	CompoNet Master Unit	CompoNet remote I/O	CJ1W-CRM21	20 words	None	0 to 94 (uses words for 2 unit numbers)	40 Units	0.40	---	130 g max.
		Communications mode No. 0: 128 inputs/ 128 outputs for Word Slaves		40 words	None	0 to 92 (uses words for 4 unit numbers)	24 Units	0.40	---	
		Communications mode No. 1: 256 inputs/ 256 outputs for Word Slaves		80 words	None	0 to 88 (uses words for 8 unit numbers)	12 Units	0.40	---	
		Communications mode No. 2: 512 inputs/ 512 outputs for Word Slaves		80 words	None	0 to 88 (uses words for 8 unit numbers)	12 Units	0.40	---	
		Communications mode No. 3: 256 inputs/ 256 outputs for Word Slaves and 128 inputs/ 128 outputs for Bit Slaves		10 words	Depends on setting	0 to 95 uses words for 1 unit number)	40 Units	0.40	---	
		Communications mode No. 8: 1,024 inputs/ 1,024 outputs for Word Slaves and 256 inputs/ 256 outputs for Bit Slaves maximum								

CJ-series CPU Bus Units

Type	Name	Specifications	Model	Number of words allocated (CIO 1500 to CIO 1899)	Unit No.	Maximum number of Units *1	Current consumption (A)		Weight	
							5 VDC	24 VDC		
CPU Bus Units *1	High-speed Analog Input Unit	4 inputs: 80 μs/2 inputs, 160 μs/4 inputs	CJ1W-ADG41 *2	25 words	0 to F	16 Units *3	0.65	---	150 g max.	
	Controller Link Units	Wired data links	CJ1W-CLK23	25 words	0 to F	8 Units	0.35	---	110 g max.	
	Serial Communications Units	One RS-232C port and one RS-422A/485 port	CJ1W-SCU41-V1	25 words	0 to F	16 Units *3	0.38 *4	---	110 g max.	
			Two RS-232C ports				CJ1W-SCU21-V1			0.28 *4
			Two RS-422A/485 ports				CJ1W-SCU31-V1			0.38
		Two RS-232C ports High-speed models	CJ1W-SCU22				0.28 *4			160 g max.
			Two RS-422A/485 ports High-speed models				CJ1W-SCU32			0.4
		One RS-232C port and one RS-422A/485 port High-speed models	CJ1W-SCU42				0.36 *4			140 g max.
	Ethernet Units	100Base-TX, FINS communications, socket service, FTP server, and mail communications	CJ1W-ETN21	25 words	0 to F	4 Units	0.37	---	100 g max.	
	EtherNet/IP Unit	Tag data links, FINS communications, CIP message communications, FTP server, etc.	CJ1W-EIP21	25 words	0 to F	*5	0.41	---	94 g max.	
	FL-net Unit	100Base-TX cyclic transmissions and message transmissions	CJ1W-FLN22	25 words	0 to F	4 Units	0.37	---	100 g max.	
	DeviceNet Unit	DeviceNet remote I/O, 2,048 points; Both Master and Slave functions, Automatic allocation possible without Configurator	CJ1W-DRM21	25 words *6	0 to F	16 Units *3	0.29	---	118 g max. *7	
	Position Control Units with EtherCAT interface *8	2 servo axes	CJ1W-NC281	25 words	0 to F	16 Units *3	0.46	---	110 g max.	
		4 servo axes	CJ1W-NC481							
		8 servo axes	CJ1W-NC881							
		16 servo axes	CJ1W-NCF81							
4 servo axes and 64 I/O slaves		CJ1W-NC482								
8 servo axes and 64 I/O slaves		CJ1W-NC882								
16 servo axes and 64 I/O slaves		CJ1W-NCF82								
EtherCAT Slave Unit	EtherCAT REMORT I/O DATA Input: 400 bytes Output: 400 bytes	CJ1W-ECT21	25 words	0 to F	16 Units	0.34	---	97g max.		
Position Control Units supporting MECHATROLINK-II communications	MECHATROLINK-II, 16 axes max.	CJ1W-NCF71(-MA)	25 words	0 to F	16 Units *3	0.36	---	95 g max.		
Motion Control Units supporting MECHATROLINK-II communications	MECHATROLINK-II, Real axes: 30 max., Virtual axes: 2 max., Special motion control language	CJ1W-MCH71	25 words	0 to F	3 Units/Rack *9	0.60	---	210 g max.		
SPU Unit (High-speed Storage and Processing Unit)	One CF card type I/II slot (used with OMRON HMC-EF□□□ Memory Card), one Ethernet port	CJ1W-SPU01-V2 *10	Not used.	0 to F	16 Units *3	0.56	---	180 g max.		

Note: Including models whose production are discontinued.

- *1. Some CJ-series CPU Bus Units are allocated words in the CPU Bus Unit Setup Area. The system must be designed so that the number of words allocated in the CPU Bus Unit Setup Area does not exceed its capacity. Refer to 4-6-2 CPU Bus Unit Setup Area in *CJ2 CPU Unit Software User's Manual* (Cat. No. W473). There may also be limits due to the capacity of the Power Supply Unit that you are using or the maximum number of Units to which memory can be allocated in the CPU Bus Unit Setup Area.
- *2. If interrupts to the CPU Unit are used, mount the Interrupt Input Unit in one of the following slots on the CPU Rack.
 - CJ2H-CPU6□-EIP: Slots 0 to 3
 - CJ2H-CPU6□ or CJ2M-CPU□□: Slots 0 to 4
- *3. Up to 15 Units can be connected for a CJ2H-CPU6□-EIP or CJ2M-CPU3□ CPU Unit.
- *4. Increases by 0.15 A/Unit when an NT-AL001 RS-232C/RS-422A Link Adapter is used. Increases by 0.04 A/Unit when a CJ1W-CIF11 RS-422A Converter is used. Increases by 0.20 A/Unit when an NV3W-M□20L(-V1) Programmable Terminal is used.
- *5. Up to seven Units can be connected for a CJ2H-CPU6□-EIP CPU Unit, up to eight Units can be connected for a CJ2H-CPU6□ CPU Unit, and up to two Units can be connected for a CJ2M CPU Unit.
- *6. Slave I/O are allocated in DeviceNet Area (CIO 3200 to CIO 3799).
- *7. Includes the weight of accessory connectors.
- *8. Only G5-series Servo Drives with Built-in EtherCAT can be connected.
- *9. When mounting to a CJ-series CPU Rack or a CJ-series Expansion Rack, one of these Units uses the space of three Units.
- *10. Use version 2 or higher of the SPU Unit with a CJ2 CPU Unit.

Checking Current Consumption and Power Consumption

After selecting a Power Supply Unit based on considerations such as the power supply voltage, calculate the current and power requirements for each Rack.

Condition 1: Current Requirements

There are two voltage groups for internal power consumption: 5 V and 24 V.

Current consumption at 5 V (internal logic power supply)

Current consumption at 24 V (relay driving power supply)

Condition 2: Power Requirements

For each Rack, the upper limits are determined for the current and power that can be provided to the mounted Units. Design the system so that the total current consumption for all the mounted Units does not exceed the maximum total power or the maximum current supplied for the voltage groups shown in the following tables.

The maximum current and total power supplied for CPU Racks and Expansion Racks according to the Power Supply Unit model are shown below.

Note 1. For CPU Racks, include the CPU Unit current and power consumption in the calculations. When expanding, also include the current and power consumption of the I/O Control Unit in the calculations.

2. For Expansion Racks, include the I/O Interface Unit current and power consumption in the calculations.

Power Supply Units	Max. current supplied		Max. total power supplied
	5 V	24 V (relay driving current)	
CJ1W-PA205C	5.0 A	0.8 A	25 W
CJ1W-PA205R	5.0 A	0.8 A	25 W
CJ1W-PA202	2.8 A	0.4 A	14 W
CJ1W-PD025	5.0 A	0.8 A	25 W
CJ1W-PD022	2.0 A	0.4 A	19.6 W

Conditions 1 and 2 below must be satisfied.

Condition 1: Maximum Current

(1) Total Unit current consumption at 5 V ≤ (A) value

(2) Total Unit current consumption at 24 V ≤ (B) value

Condition 2: Maximum Power

(1) × 5 V + (2) × 24 V ≤ (C) value

Example: Calculating Total Current and Power Consumption

Example: When the Following Units are Mounted to a CJ-series CPU Rack Using a CJ1W-PA205R Power Supply Unit

Unit type	Model	Quantity	Voltage group	
			5 V	24 V
CPU Unit	CJ2H-CPU68-EIP	1	0.820 A	---
I/O Control Unit	CJ1W-IC101	1	0.020 A	---
Basic I/O Units (Input Units)	CJ1W-ID211	2	0.080 A	---
	CJ1W-ID231	2	0.090 A	---
Basic I/O Units (Output Units)	CJ1W-OC201	2	0.090 A	0.048 A
Special I/O Unit	CJ1W-DA041	1	0.120 A	---
CPU Bus Unit	CJ1W-CLK23	1	0.350 A	---
Current consumption	Total		$0.820 + 0.020 + 0.080 \times 2 + 0.090 \times 2 + 0.090 \times 2 + 0.120 + 0.350$	$0.048 A \times 2$
	Result		1.83 A (≤ 5.0 A)	0.096 A (≤ 0.8 A)
Power consumption	Total		$1.83 \times 5 V = 9.15 W$	$0.096 A \times 24 V = 2.30 W$
	Result		$9.15 + 2.30 = 11.45 W (\leq 25 W)$	

Note: For details on Unit current consumption, refer to *Ordering Information*.

Using the CX-Programmer to Display Current Consumption and Width

CPU Rack and Expansion Rack current consumption and width can be displayed by selecting Current Consumption and Width from the Options Menu in the CJ2 Table Window. If the capacity of the Power Supply Unit is exceeded, it will be displayed in red characters.

Example:

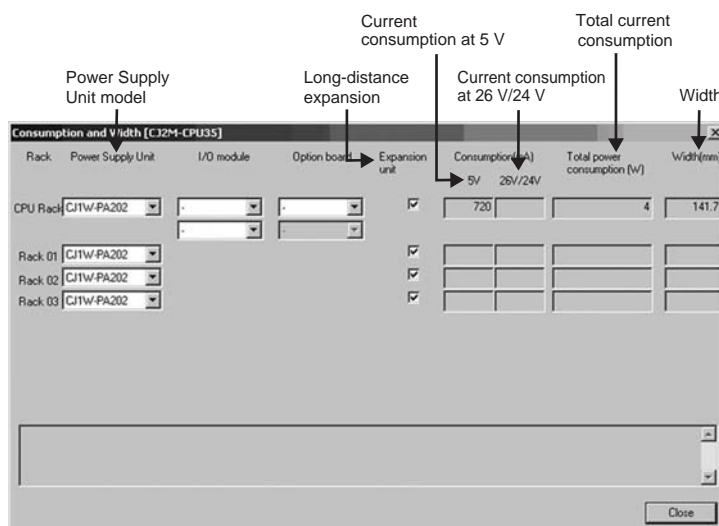

Dimensions

Note: Units are in mm unless specified otherwise.

Product Dimensions

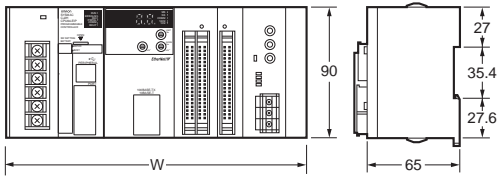

Example Rack Widths using CJ1WPA202 Power Supply Unit (AC, 14 W)

No. of Units mounted with 31-mm width	Rack width (mm)			
	With CJ2H-CPU6□-EIP	With CJ2H-CPU6□	With CJ2M-CPU3□	With CJ2M-CPU1□
1	170.5	139.5	152.7	121.7
2	201.5	170.5	183.7	152.7
3	232.5	201.5	214.7	183.7
4	263.5	232.5	245.7	214.7
5	294.5	263.5	276.7	245.7
6	325.5	294.5	307.7	276.7
7	356.5	325.5	338.7	307.7
8	387.5	356.5	369.7	338.7
9	418.5	387.5	400.7	369.7
10	449.5	418.5	431.7	400.7

Power Supply Units, CPU Units, and End Covers

Unit/product	Model	Width
Power Supply Unit	CJ1W-PA205C	80
	CJ1W-PA205R	80
	CJ1W-PA202	45
	CJ1W-PD025	60
	CJ1W-PD022	27
CPU Unit	CJ2H-CPU6□-EIP	79.8
	CJ2H-CPU6□	48.8
	CJ2M-CPU3□	62
	CJ2M-CPU1□	31
End Cover	CJ1W-TER01	14.7

Power Supply Units

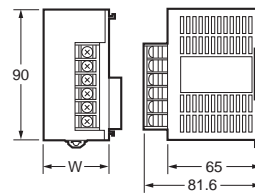

W=27: CJ1W-PD022
 W=45: CJ1W-PA202
 W=80: CJ1W-PA205R
 CJ1W-PA205C
 W=60: CJ1W-PD025

End Cover (included with CPU Units)

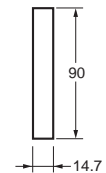

RS-422A Adapter CJ1W-CIF11

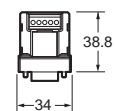

CPU Units CJ2H-CPU6□-EIP

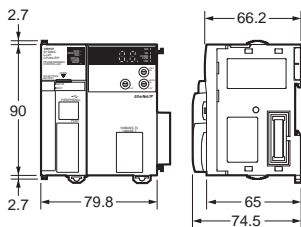

CJ2H-CPU6□

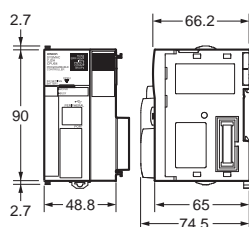

CJ2M-CPU3□

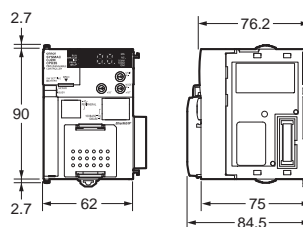

CJ2M-CPU1□

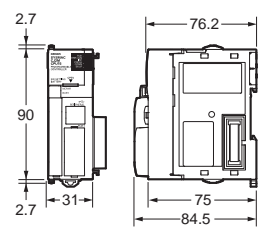

Option Boards (CJ2M-CPU3□ only)

Serial Option Boards CP1W-CIF01

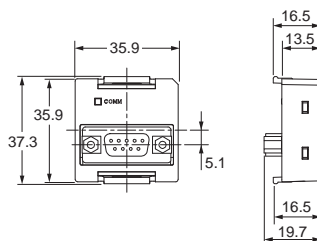

CP1W-CIF11/CP1W-CIF12-V1

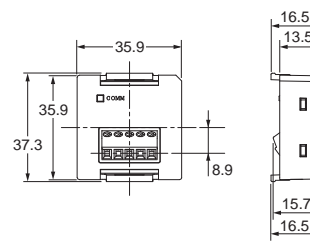

● Units of Width 20 mm

Unit/product	Model	Width
I/O Control Unit	CJ1W-IC101	20
Pulse I/O Modules	CJ2M-MD211/212	
32-point Basic I/O Units	CJ1W-ID231/232/233	
	CJ1W-OD231/232/233/234	
B7A Interface Unit	CJ1W-B7A22	
	CJ1W-B7A14	
	CJ1W-B7A04	
CompoBus/S Master Unit	CJ1W-SRM21	
Space Unit	CJ1W-SP001	

● I/O Control Unit

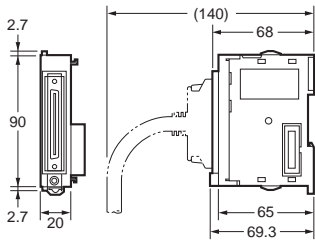

● Pulse I/O Modules (Only CJ2M CPU Unit)

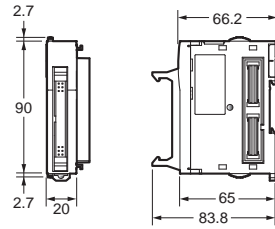

● 32-Point I/O Units (CJ1W-ID223□/OD23□)

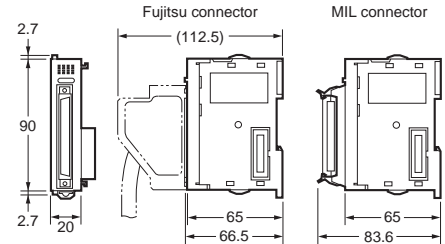

● Units of Width 31 mm

Unit	Model	Width
I/O Interface Unit	CJ1W-II101	31
8/16-point Basic I/O Units	CJ1W-ID201	
	CJ1W-ID211/212	
	CJ1W-IA111/201	
	CJ1W-OD20□	
	CJ1W-OD211/212/213	
	CJ1W-OC201/211	
	CJ1W-OA201	
32-point Basic I/O Units	CJ1W-MD231	
	CJ1W-MD232/233	
64-point Basic I/O Units	CJ1W-ID261	
	CJ1W-OD261	
	CJ1W-MD261	
	CJ1W-ID262	
	CJ1W-OD262/263	
Interrupt Input Unit	CJ1W-INT01	
	Quick-response Input Unit	
Analog I/O Units	CJ1W-AD□□□□ (-V1)	
	CJ1W-DA□□□□ (□)	
	CJ1W-MAD42	
Process Input Units	CJ1W-PH41U	
	CJ1W-AD04U	
	CJ1W-PTS51/52/15/16	
	CJ1W-PDC15	
Temperature Control Units	CJ1W-TC□□□□	
Position Control Units	CJ1W-NC113/133	
	CJ1W-NC213/233	
	CJ1W-NC413/433	
Position Control Unit with EtherCAT interface	CJ1W-NC281	
	CJ1W-NC481	
	CJ1W-NC881	
	CJ1W-NCF81	
	CJ1W-NC482	
	CJ1W-NC882	
	CJ1W-NCF82	
EtherCAT Slave Unit	CJ1W-ECT21	
Position Control Unit with MECHATROLINK-II interface	CJ1W-NCF71	
High-speed Counter Unit	CJ1W-CT021	
ID Sensor Units	CJ1W-V680C11	
	CJ1W-V680C12	
	CJ1W-V600C11	
	CJ1W-V600C12	

Unit	Model	Width
Controller Link Units	CJ1W-CLK23	31
Serial Communications Units	CJ1W-SCU22	
	CJ1W-SCU32	
	CJ1W-SCU42	
	CJ1W-SCU41-V1	
	CJ1W-SCU21-V1	
CJ1W-SCU31-V1		
EtherNet/IP Unit	CJ1W-EIP21	
Ethernet Unit	CJ1W-ETN21	
DeviceNet Unit	CJ1W-DRM21	
CompoNet Master Unit	CJ1W-CRM21	
FL-net Unit	CJ1W-FLN22	

● I/O Interface Unit

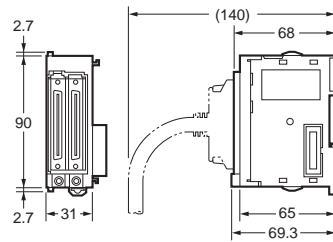

● 8/6-point Basic I/O Units, Interrupt Input Unit, and High-speed Input Unit

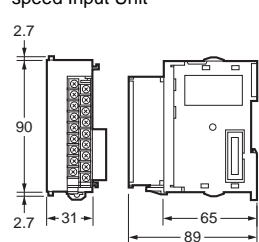

● 64-point Basic I/O Units and 32-point Basic I/O Units (CJ1W-MD23□)

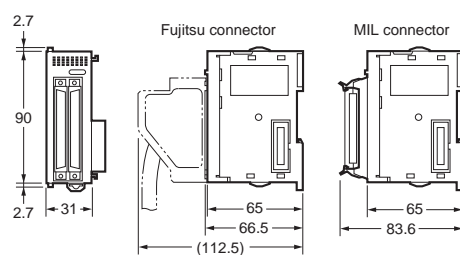

● Special I/O Units and CPU Bus Units

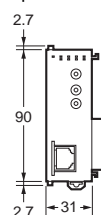

● Units of Width 51 mm

Unit	Model	Width
SPU Unit (High-speed Data Storage Unit)	CJ1W-SPU01-V2	51
Position Control Units (High-speed type)	CJ1W-NC214/234	

● SPU Unit (High-speed Data Storage Unit)
CJ1W-SPU01-V2

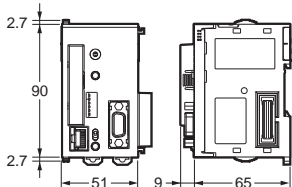

● Unit of Width 62 mm

Unit	Model	Width
Position Control Units (High-speed type)	CJ1W-NC414/434	62

● Position Control Unit (High-speed model)
CJ1W-NC414/434

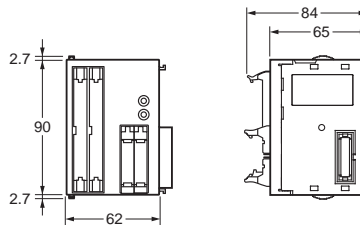

■ Mounting Dimensions

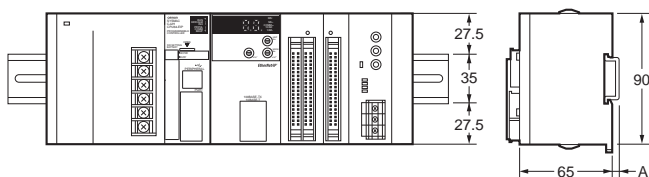

DIN Track model number	A
PFP-100N2	16 mm
PFP-100N	7.3 mm
FPP-50N	7.3 mm

■ Mounting Height

The mounting height of CJ-series CPU Racks and Expansion Racks is from 81.6 to 89.0 mm depending on the Units that are mounted.

Additional height is required to connect Programming Devices (e.g., CX-Programmer) and Cables. Be sure to allow sufficient mounting height.

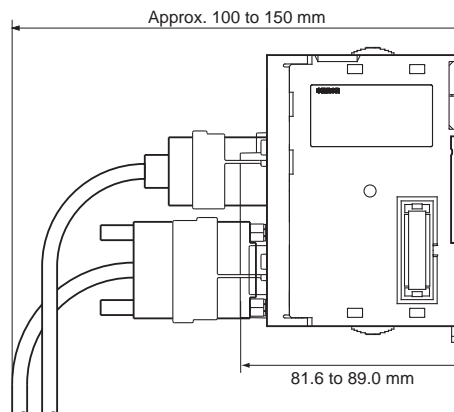

Note: Consider the following points when expanding the configuration:
The total length of I/O Connecting Cable must not exceed 12 m.
I/O Connecting Cables require the bending radius indicated below.

● Expansion Cable

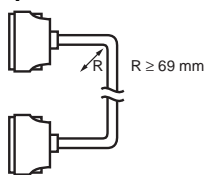

Note: Outer diameter of cable: 8.6 mm.

General Specifications

Item	CJ2H-					CJ2M-	
	CPU64 (-EIP)	CPU65 (-EIP)	CPU66 (-EIP)	CPU67 (-EIP)	CPU68 (-EIP)	CPU1□	CPU3□
Enclosure	Mounted in a panel						
Grounding	Less than 100 Ω						
CPU Unit Dimensions (H × D × W)	CJ2H-CPU6□-EIP : 90 mm × 65 mm × 80 mm CJ2H-CPU6□ : 90 mm × 65 mm × 49 mm					90 mm × 75 mm × 31 mm	90 mm × 75 mm × 62 mm
Weight *1	CJ2H-CPU6□-EIP : 280 g or less CJ2H-CPU6□ : 190 g or less					130 g or less	190 g or less *2
Current Consumption	CJ2H-CPU6□-EIP : 5 VDC, 0.82 A CJ2H-CPU6□ : 5 VDC, 0.42 A					5 VDC, 0.5 A	5 VDC, 0.7 A
Operation Environment	Ambient Operating Temperature	0 to 55°C					
	Ambient Operating Humidity	10% to 90% (with no condensation)					
	Atmosphere	Must be free from corrosive gases.					
	Ambient Storage Temperature	-20 to 70°C (excluding battery)					
	Altitude	2,000 m or less					
	Pollution Degree	2 or less: Meets IEC 61010-2-201.					
	Noise Immunity	2 kV on power supply line (Conforms to IEC 61000-4-4.)					
	Overvoltage Category	Category II: Meets IEC 61010-2-201.					
	EMC Immunity Level	Zone B					
	Vibration Resistance	Conforms to IEC60068-2-6. 5 to 8.4 Hz with 3.5-mm amplitude, 8.4 to 150 Hz Acceleration of 9.8 m/s ² for 100 min in X, Y, and Z directions (10 sweeps of 10 min each = 100 min total)					
Shock Resistance	Conforms to IEC60068-2-27. 147 m/s ² , 3 times in X, Y, and Z directions (100 m/s ² for Relay Output Units)						
Battery	Life	5 years at 25°C					
	Weight	Approx. 10 g					
	Model	CJ1W-BAT01					
Applicable Standards	Conforms to cULus, NK, LR and EC Directives.						

*1. Includes the weight of end covers and battery.

*2. Without a Serial Option Board.

Performance Specifications

Item		CJ2H-					CJ2M-					
		CPU64 (-EIP)	CPU65 (-EIP)	CPU66 (-EIP)	CPU67 (-EIP)	CPU68 (-EIP)	CPU 11/31	CPU 12/32	CPU 13/33	CPU 14/34	CPU 15/35	
User Memory		50K steps	100K steps	150K steps	250K steps	400K steps	5K steps	10K steps	20K steps	30K steps	60K steps	
I/O Bits		2,560 bits										
Processing Speed	Overhead Processing Time *1	Normal Mode: CJ2H-CPU6□-EIP : 200 μs CJ2H-CPU6□ : 100 μs					Normal Mode: CJ2M-CPU3□ : 270 μs CJ2M-CPU1□ : 160 μs					
	Execution Time	Basic Instructions: 0.016 μs min.; Special Instructions: 0.048 μs min.					Basic Instructions: 0.04 μs min.; Special Instructions: 0.06 μs min.					
	Interrupts	I/O Interrupts and External Interrupts	Interrupt task startup time: 17 μs *2 or 26 μs (30 μs for unit version 1.0) Return times to cyclic tasks: 8 μs *2 or 11 μs (15 μs for unit version 1.0)					Interrupt task startup time: 31 μs Return times to cyclic tasks: 10 μs				
		Scheduled Interrupts	Minimum time interval: 0.2 ms *2 (set in 0.1-ms increments) Interrupt task startup time: 13 μs *2 or 22 μs (27 μs for unit version 1.0) Return times to cyclic tasks: 8 μs *2 or 11 μs (15 μs for unit version 1.0)					Minimum time interval: 0.4 ms (set in 0.1-ms increments) Interrupt task startup time: 30 μs Return time to cyclic task: 11 μs				
Maximum Number of Connectable Units		Total per CPU Rack or Expansion Rack: 10 Units max.; Total per PLC: 40 Units max.										
	Basic I/O Units	No limit However, a maximum of two CJ1W-INT01 Interrupt Input Units can be mounted.										
	Special I/O Units	Units for up to 96 unit numbers can be mounted. (Unit numbers run from 0 to 95. Units are allocated between 1 and 8 unit numbers.)										
	CPU Bus Units	CJ2M-CPU3□: 15 Units max. CJ2M-CPU1□: 16 Units max.										
	Pulse I/O Modules	2 Units max. *3										
	Slots for which interrupts can be used	Slots 0 to 4 on CPU Rack										
Maximum Number of Expansion Racks		3 max.										
CIO Area	I/O Area	2,560 bits (160 words): Words CIO 0000 to CIO 0159										
	Link Area	3,200 bits (200 words): Words CIO 1000 to CIO 1199										
	Synchronous Data Refresh Area	1,536 bits (96 words): Words CIO 1200 to CIO 1295									---	
	CPU Bus Unit Area	6,400 bits (400 words): Words CIO 1500 to CIO 1899										
	Special I/O Unit Area	15,360 bits (960 words): Words CIO 2000 to CIO 2959										
	Pulse I/O Area	---					20 inputs, 12 outputs (CIO 2960 to CIO 2963) *3					
	Serial PLC Link Words	---					1,440 bits (90 words): Words CIO 3100 to CIO 3189					
	DeviceNet Area	9,600 bits (600 words): Words CIO 3200 to CIO 3799										
	Internal I/O Area	3,200 bits (200 words): Words CIO 1300 to CIO 1499 (Cannot be used for external I/O.) 37,504 bits (2,344 words): Words CIO 3800 to CIO 6143 (Cannot be used for external I/O.)										
Work Area		8,192 bits (512 words): Words W000 to W511 (Cannot be used for external I/O.)										
Holding Area		8,192 bits (512 words): Words H000 to H511 Bits in this area maintain their ON/OFF status when PLC is turned OFF or operating mode is changed. Words H512 to H1535: These words can be used only for function blocks. They can be used only for function block instances (i.e., they are allocated only for internal variables in function blocks).										
Auxiliary Area		Read-only: 31,744 bits (1,984 words) • 7,168 bits (448 words): Words A0 to A447 • 24,576 bits (1,536 words): Words A10000 to A11535 *4 Read/write: 16,384 bits (1,024 words) in words A448 to A1471 *4										
Temporary Area		16 bits: TR0 to TR15										
Timer Area		4,096 timer numbers (T0000 to T4095 (separate from counters))										
Counter Area		4,096 counter numbers (C0000 to C4095 (separate from timers))										
DM Area		32k words *5 DM Area words for Special I/O Units: D20000 to D29599 (100 words × 96 Units) DM Area words for CPU Bus Units: D30000 to D31599 (100 words × 16 Units)										
EM Area		32k words/bank × 25 banks max.: E00_00000 to E18_32767 max. *5, *6					32k words/bank × 4 banks max.: E00_00000 to E3_32767 max. *5					
		32K words × 4 banks	32K words × 4 banks	32K words × 10 banks	32K words × 15 banks	32K words × 25 banks	32K words × 1 bank			32K words × 4 banks		

*1. The following times are added if EtherNet/IP data tag links are used for the CJ2H-CPU6□-EIP.

Normal operation: 100 μs + Number of transfer words x 0.33 μs
High-speed interrupt enabled: 100 μs + Number of transfer words x 0.87 μs
The following time must be added when using EtherNet/IP tag data links for the CJ2M-CPU3□.
100 μs + (No. of words transferred x 1.8 μs)

The following time must be added when using Pulse I/O Modules with a CJ2M CPU Unit: 10 μs x Number of Pulse I/O Modules.

*2. This applies when High-speed interrupt function is used.

*3. Supported only by CJ2M CPU Units with unit version 2.0 or later. A Pulse I/O Module must be mounted.

*4. A960 to A1471 and A10000 to A11535 cannot be accessed by CPU Bus Units, Special I/O Units, PTs, and Support Software that do not specifically support the CJ2 CPU Units.

*5. Bits in the EM Area can be addressed either by bit or by word. These bits cannot be addressed by CPU Bus Units, Special I/O Units, PTs, and Support Software that do not specifically support the CJ2 CPU Units.

*6. EM banks D to 18 cannot be accessed by CPU Bus Units, Special I/O Units, PTs, and Support Software that do not specifically support the CJ2 CPU Units.

Item		CJ2H-					CJ2M-				
		CPU64 (-EIP)	CPU65 (-EIP)	CPU66 (-EIP)	CPU67 (-EIP)	CPU68 (-EIP)	CPU 11/31	CPU 12/32	CPU 13/33	CPU 14/34	CPU 15/35
Banks for which bits can be force-set/reset *7	Using EM Area force-setting/resetting	Banks 0 to 3 hex	Banks 0 to 3 hex	Banks 0 to 9 hex	Banks 0 to E hex	Banks 0 to 18 hex	Bank 0 hex			Banks 0 to 3 hex	
	Using automatic address allocation specifications	Bank 3 hex	Bank 3 hex	Banks 6 to 9 hex	Banks 7 to E hex	Banks 11 to 18 hex	---				
Index Registers		IR0 to IR15 These are special registers for storing PLC memory addresses for indirect addressing. (Index Registers can be set so that they are unique in each task or so that they are shared by all tasks.)									
Cyclic Task Flag Area		128 flags									
Memory Card		128 MB, 256 MB, or 512 MB									
Operating Modes		PROGRAM Mode: Programs are not executed. Preparations can be executed prior to program execution in this mode. MONITOR Mode: Programs are executed, and some operations, such as online editing, and changes to present values in I/O memory, are enabled in this mode. RUN Mode: Programs are executed. This is the normal operating mode.									
Execution Mode		Normal Mode									
Programming Languages		Ladder Logic (LD), Sequential Function Charts (SFC), Structured Text (ST), and Instruction Lists (IL)									
Function Blocks	Maximum number of definitions	2,048					256			2,048	
	Maximum number of instances	2,048					256			2,048	
FB Program Area		---					20K steps				
Tasks	Type of Tasks	Cyclic tasks Interrupt tasks (Power OFF interrupt tasks, scheduled interrupt tasks, I/O interrupt tasks, and external interrupt tasks, and input interrupt tasks *3)									
	Number of Tasks	Cyclic tasks: 128 Interrupt tasks: 256 (Interrupt tasks can be defined as cyclic tasks to create extra cyclic tasks. Therefore, the total number of cyclic tasks is actually 384 max.)									
Symbols (Variables)	Type of Symbols	<ul style="list-style-type: none"> Local symbols: Can be used only within a single task in the PLC. Global symbols: Can be used in all tasks in the PLC. Network symbols (tags) *8: I/O memory in the CPU Unit can be externally accessed using symbols, depending on parameter settings. 									
	Data Type of Symbols	<ul style="list-style-type: none"> • BOOL (bit) • UINT (one-word unsigned binary) • UDINT (two-word unsigned binary) • ULINT (four-word unsigned binary) • INT (one-word signed binary) • DINT (two-word signed binary) • LINT (four-word signed binary) • UINT BCD (one-word unsigned BCD) *9 • UDINT BCD (two-word unsigned BCD) *9 • ULINT BCD (four-word unsigned BCD) *9 • REAL (two-word floating-point) • LREAL (four-word floating-point) • CHANNEL (word) *9 • NUMBER (constant or number) *9 • WORD (one-word hexadecimal) • DWORD (two-word hexadecimal) • LWORD (four-word hexadecimal) • STRING (1 to 255 ASCII characters) • TIMER *10 • COUNTER *10 • user-defined data types (delta structures) *11 									
Maximum Size of Symbol		32k words									
Array Symbols (Array Variables)		One-dimensional arrays									
Number of Array Elements		32,000 elements max.									
Number of Registrable Network Symbols (Tags) *8		20,000 max.					2,000 max.				
Length of Network Symbol (Tag) Name *8		255 bytes max.									
Encoding of Network Symbols (Tags) *8		UTF-8									

*7. With CJ2H CPU Units with unit version 1.2 or later, force-setting/resetting bits in the EM Area is possible either for banks that have been specified for automatic address assignment or for banks specified for the EM Area force-set/reset function. With CJ2M CPU Units, force-setting/resetting bits in the EM Area is possible only for banks specified for the EM Area force-set/reset function.

*8. Supported only by the CJ2H-CPU6□-EIP and CJ2M-CPU3□.

*9. This data type cannot be used in Function blocks.

*10. This data type can be used only in Function blocks.

*11. Supported only when CX-Programmer version 9.0 or later is used.

Item		CJ2H-					CJ2M-					
		CPU64 (-EIP)	CPU65 (-EIP)	CPU66 (-EIP)	CPU67 (-EIP)	CPU68 (-EIP)	CPU 11/31	CPU 12/32	CPU 13/33	CPU 14/34	CPU 15/35	
Data Tracing	Memory Capacity	8,000 words		16,000 words	32,000 words		8,000 words					
		The EM Area can be specified from the CX-Programmer to use up to 32K words multiplied by the number of banks supported by the CPU Unit model.										
	Number of Samplings	Bits = 31, one-word data = 16, two-word data = 8, four-word data = 4										
	Sampling Cycle	1 to 2,550 ms (Unit: 1 ms)										
	Trigger Conditions	ON/OFF of specified bit Data comparison of specified word Data size: 1 word, 2 words, 4 words Comparison Method: Equals (=), Greater Than (>), Greater Than or Equals (≥), Less Than (<), Less Than or Equals (≤), Not Equal (≠)										
	Delay Value	-32,768 to +32,767 ms										
File Memory		Memory Card (128, 256, or 512 Mbytes) (Use the Memory Cards provided by OMRON.) EM file memory (Part of the EM Area can be converted for use as file memory.)										
Source/ Comment Memory	Function block program memory, comment file, program index file, symbol tables	Capacity: 3.5 Mbytes					Capacity: 1 Mbytes					
Comm unicati ons	Logical Ports for Communications	Logical Ports	8 ports (Used for SEND, RECV, CMND, PMCR, TXDU, and RXDU instructions.)									
		Extended Logical Ports	64 ports (Used for SEND2, RECV2, CMND2, and PMCR2 instructions.)									
	CIP Communications Specification	Class 3 (Connection Type)	Number of connections: 128									
		UCMM (Non-connection Type)	Maximum number of clients that can communicate at the same time: 32 Maximum number of servers that can communicate at the same time: 32				Maximum number of clients that can communicate at the same time: 16 Maximum number of servers that can communicate at the same time: 16					
	Peripheral (USB) Port		USB 2.0-compliant B-type connector									
		Baud Rate	12 Mbps max.									
		Transmission Distance	5 m max.									
	Serial Port		Interface: Conforms to EIA RS-232C.					<ul style="list-style-type: none"> • CJ2M-CPU1□ interface: Conforms to EIA RS-232C. • CJ2M-CPU3□: No serial ports with default system One of the following Serial Option Boards can be mounted. • CP1W-CIF01 RS-232C Option Board • CP1W-CIF11 RS-422A/485 Option Board (not isolated, max. transmission distance: 50 m) • CP1W-CIF12-V1 RS-422A/485 Option Board (isolated, max. transmission distance: 500 m) 				
		Communications Method	Half-duplex									
		Synchronization Method	Start-stop									
	Baud Rate	0.3, 0.6, 1.2, 2.4, 4.8, 9.6, 19.2, 38.4, 57.6, or 115.2 (kbps)										
	Transmission Distance	15 m max.										

Item		CJ2H-					CJ2M-						
		CPU64 (-EIP)	CPU65 (-EIP)	CPU66 (-EIP)	CPU67 (-EIP)	CPU68 (-EIP)	CPU 11/31	CPU 12/32	CPU 13/33	CPU 14/34	CPU 15/35		
Communications	EtherNet/IP Port *12	---											
	Transmission Specifications	Media Access Method	CSMA/CD										
		Modulation	Baseband										
		Transmission Paths	Star										
		Baud Rate	100 Mbps (100Base-TX)										
		Transmission Media	Shielded twisted-pair (STP) cable; Categories: 5, 5e										
		Transmission Distance	100 m (between ethernet switch and node)										
		Number of Cascade Connections	No restrictions if ethernet switch is used.										
	Communications Specifications	CIP Communications: Tag Data Links	---										
		Number of Connections	256					32					
		Packet Interval (Refresh period)	0.5 to 10,000 ms (Unit: 0.5 ms) Can be set for each connection. (Data will be refreshed at the set interval, regardless of the number of nodes.)					1 to 10,000 ms (in 0.5-ms increments) Can be set for each connection. (Data will be refreshed at the set interval, regardless of the number of nodes.)					
		Maximum allowed communications bandwidth per Unit	6,000 to 12,000 packets per second *13 *14					3,000 packets per second *13					
		Number of Tag Sets	256					32					
		Type of Tags	CIO, DM, EM, HR, WR, and network symbols										
		Number of Tags per Connection	8 (Seven tags if PLC status is included in the segment.)										
		Maximum Link Data Size per Node (total size of all tags)	184,832 words					640 words					
		Maximum Data Size per Connection	252 or 722 words *15 (Data is synchronized within each connection.)					640 words *16 (Data is synchronized within each connection.)					
		Number of Registrable Tag Set	256 (1 connection = 1 segment)					32 (1 connection = 1 segment)					
		Maximum Tag Set Size	722 words (One word is used when PLC status is included in the segment.)					640 words *16 (One word is used when PLC status is included in the segment.)					
		Maximum Number of Tags Refreshable in a Single Cycle of CPU Unit *17	Output/send (CPU Unit to EtherNet/IP): 256 Input/receive (EtherNet/IP to CPU Unit): 256					Output/send (CPU Unit to EtherNet/IP): 32 Input/receive (EtherNet/IP to CPU Unit): 32					
		Data Size Refreshable in a Single Cycle of CPU Unit *17	Output/send (CPU to EtherNet/IP): 6,432 words Input/receive (EtherNet/IP to CPU): 6,432 words					Output/send (CPU Unit to EtherNet/IP): 640 words Input/receive (EtherNet/IP to CPU Unit): 640 words					
		Change of Tag Data Link Parameter Settings during Operation	OK *18										
		Multi-cast Packet Filter *19	OK										
		CIP Communications: Explicit Messages	CIP Communications: Explicit Messages	---									
			Class 3 (Connection Type)	Number of connections: 128									
UCMM (Non-connection Type)			Maximum number of clients that can communicate at the same time: 32 Maximum number of servers that can communicate at the same time: 32					Maximum number of clients that can communicate at the same time: 16 Maximum number of servers that can communicate at the same time: 16					
CIP Routing	OK (CIP routing is enabled for the following remote Units: CJ1W-EIP21, CJ2H-CPU6□-EIP, CJ2M-CPU3□ and CS1W-EIP21.)												
FINS Communications	---												
FINS Communications	FINS/UDP	OK											
	FINS/TCP	16 connections max.											
	EtherNet/IP Conformance Test	Conforms to A5.											
EtherNet/IP Interface	10Base-T/100Base-TX Auto Negotiation/Fixed Setting												

- *12. The EtherNet/IP port is built into the CJ2H-CPU6□-EIP and CJ2M-CPU3□ only.
- *13. "Packets per second" is the number of communications packets that can be processed per second.
- *14. When using the EtherNet/IP Unit with version 3.0 or later. When using the EtherNet/IP Unit with version 2.1 or earlier, the maximum allowed communications bandwidth per Unit is 6,000 pps. When using the EtherNet/IP Unit with version 3.0 or later, the Network Configurator with version 3.57 or higher is required.
- *15. Large Forward Open (CIP optional specification) must be supported in order for 505 to 1,444 bytes to be used as the data size. Application is supported between CS/CJ-series PLCs. When connecting to devices from other manufacturers, make sure that the devices support the Large Forward Open specification.
- *16. Unit maximum 2.0 of built-in EtherNet/IP section: 20 words.
- *17. If the maximum number is exceeded, refreshing will require more than one CPU Unit cycle.
- *18. When changing parameters, however, the EtherNet/IP port where the change is made will be restarted. In addition, a timeout will temporarily occur at the other node that was communicating with that port, and it will then recover automatically.
- *19. The EtherNet/IP port supports an IGMP client, so unnecessary multicast packets are filtered by using an ethernet switch that supports IGMP snooping.

Function Specifications

Functions		Description	
Cycle Time Management	Minimum Cycle Time	A minimum cycle time can be set. (0.2 to 32,000 ms; Unit: 0.1 ms) The minimum cycle time setting can be changed in MONITOR mode. *1	
	Cycle Time Monitoring	The cycle time is monitored. (0.01 to 40,000 ms; Unit: 0.01 ms)	
	Background Processing	Instructions with long execution times can be executed over multiple cycles to prevent fluctuations in the cycle time.	
Unit (I/O) Management	Basic I/O Units, Special I/O Units, and CPU Bus Units	I/O Refreshing	Cyclic Refreshing Cyclic refreshing of Basic I/O Units, Special I/O Units, and CPU Bus Units
			Immediate Refreshing I/O refreshing by immediate refreshing instructions
			Refreshing by IORF I/O refreshing by IORF instruction
		Unit Recognition at Startup	The number of units recognized when the power is turned ON is displayed.
	Basic I/O Units	Input Response Time Setting	The input response times can be set for Basic I/O Units. The response time can be increased to reduce the effects of chattering and noise at input contacts. The response time can be decreased to enable detecting shorter input pulses.
		Load OFF Function	All of the outputs on Basic I/O Units can be turned OFF when an error occurs in RUN or MONITOR mode.
		Basic I/O Unit Status Monitoring	Alarm information can be read from Basic I/O Units and the number of Units recognized can be read.
		Reading/writing data using instructions for specific Units *1	Special instructions can be used to read/write required data for specific Units at high speed.
	Special I/O Units and CPU Bus Units	Unit Restart Bits to Restart Units	A Special I/O Unit or CPU Bus Unit can be restarted.
		Synchronous Unit Operation *2	The start of processing for all the specified Units can be synchronized at a fixed interval. Maximum number of Units: 10 Units (Only Units that support Synchronous Operation Mode can be used.) Synchronous operation cycle: 0.5 to 10 ms (default: 2 ms) Maximum number of words for synchronous data refreshing: 96 words (total of all Units)
	Configuration Management	Automatic I/O Allocation at Startup	I/O words can be automatically allocated to the Basic I/O Units that are connected in the PLC to start operation automatically without registering Units into I/O tables.
		I/O Table Creation	The current unit configuration can be registered in I/O tables to prevent it from being changed, to reserve words, and to set words.
		Rack/Slot First Word Settings	The first words allocated to a Units on the Racks can be set.
Memory Management	Holding I/O Memory when Changing Operating Modes	The status of I/O memory can be held when the operating mode is changed or power is turned ON. The forced-set/reset status can be held when the operating mode is changed or power is turned ON.	
	File Memory	Files (such as program files, data files, and symbol table files) can be stored in Memory Card, EM File Memory, or Comment Memory.	
	Built-in Flash Memory	The user program and Parameter Area can be backed up to an internal flash memory when they are transferred to the CPU Unit.	
	EM File Function	Parts of the EM Area can be treated as file memory.	
	Storing Comments	I/O comments can be stored as symbol table files in a Memory Card, EM file memory, or comment memory.	
	EM Configuration	EM Area can be set as trace memory or EM file memory.	
Memory Cards	Automatic File Transfer at Startup	A program file and parameter files can be read from a Memory Card when the power is turned ON.	
	Program Replacement during PLC Operation	User programs can be transferred from a Memory Card to CPU Unit during operation.	
	Function for Reading and Writing Data from a Memory Card	Data in I/O memory in the CPU Unit can be written to a Memory Card in CSV/TXT format. Data in CSV/TXT format in the Memory Card can be read to I/O memory in the CPU Unit.	

*1. Supported only by the CJ2H CPU Units with unit version 1.1 or later and CJ2M CPU Units.

*2. Position Control Units (High-speed type) CJ1W-NC□□4 supported by the CJ2H CPU Units with unit version 1.1 or later.
Position Control Units with EtherCAT interface CJ1W-NC□□82 are supported by the CJ2H CPU Units with unit version 1.4 or later.

Functions		Description
Communications		---
Peripheral (USB) Port	Peripheral Bus	Bus for communications with various kinds of Support Software running on a personal computer. High-speed communications are supported.
Serial Port *3		---
Host Link (SYSWAY) Communications		Host Link commands or FINS commands placed between Host Link headers and terminators can be sent from a host computer or PT to read/write I/O memory, read/control the operating mode, and perform other operations for PLC.
No-protocol Communications		I/O instructions for communications ports (such as TXD/RXD instructions) can be used for data transfer with peripheral devices such as bar code readers and printers.
NT Link Communications		I/O memory in the PLC can be allocated and directly linked to various PT functions, including status control areas, status notification areas, touch switches, lamps, memory tables, and other objects.
Peripheral Bus		Bus for communications with various kinds of Support Software running on a personal computer. High-speed communications are supported.
Serial Gateway		This gateway enables receiving and automatically converting FINS to the CompoWay/F.
Serial PLC Links *4		Data is exchanged between CPU Units using serial ports without communications programming. PTs set to the 1:N NT Link protocol can be included in the network.
EtherNet/IP Port *5		100Base-TX/10Base-T Protocols: TCP/IP, UDP, ARP, ICMP (ping only), BOOTP Applications: FINS, CIP, SNTP, DNS (Client), FTP (Server)
CIP Communications Service	Tag Data Links Message Communications	Programless cyclic data exchanges with the devices on the EtherNet/IP network. Any CIP commands can be received from the devices on the EtherNet/IP network.
FINS Communications Service	Message Communications	Any FINS commands can be transferred with the devices on the EtherNet/IP network.
Interrupt		
Scheduled Interrupts		Tasks can be executed at a specified interval
Resetting and restarting with MSKS(690) *6		When MSKS(690) is executed, the internal timer is restarted and the time to first interrupt is set to a fixed value.
Reading present value of internal timer with MSKS(690) *6		MSKS(690) can be used to read the time that has elapsed until the schedule interrupt is started or since the previous scheduled interrupt.
Power OFF Interrupts		A task can be executed when CPU Unit's power turns OFF.
I/O Interrupt Tasks		A task can be executed when an input signal is input to an Interrupt Input Unit.
External Interrupt Tasks		A task can be executed when interrupts are requested from a Special I/O Unit or a CPU Bus Unit.
High-speed Interrupt Function *7		Improves performance for executing interrupt tasks with certain restrictions.
Clock		
Clock Function		Clock data is stored in memory. Accuracy (Accuracy depends on the temperature.) Ambient temperature of 55°C: -3.5 to +0.5 min error per month Ambient temperature of 25°C: -1.5 to +1.5 min error per month Ambient temperature of 0°C: -3 to +1 min error per month
Operation Start Time Storage		The time when operating mode was last changed to RUN mode or MONITOR mode is stored.
Operation Stop Time Storage		The last time a fatal error occurred or the last time the operating mode was changed to PROGRAM mode is stored.
Startup Time Storage		The time when the power was turned ON is stored.
Power Interruption Time Storage		The time when the power is turned OFF is stored.
Total Power ON Time Calculation		The total time that the PLC has been ON is stored in increments of 10 hours.
Power ON Clock Data Storage		A history of the times when the power was turned ON is stored.
User Program Overwritten Time Storage		The time that the user program was last overwritten is stored.
Parameter Date Storage		The time when the Parameter Area was overwritten is stored.

*3. A Serial Option Board is required to use a serial port for the CJ2M-CPU3□ CJ2M CPU Unit.

*4. A Serial Option Board is required to use the CJ2M-CPU3□ CJ2M CPU Unit in Serial PLC Links.

*5. Supported only by the CJ2H-CPU6□-EIP and CJ2M-CPU3□.

*6. Supported only by the CJ2M CPU Units.

*7. Supported only by the CJ2H CPU Units with unit version 1.1 or later.

Functions		Description	
Power Supply Management	Memory Protection	Holding Area data, DM Area data, EM Area data, Counter Completion Flags, and counter present values are held even when power is turned OFF. CIO Area, Work Area, some Auxiliary Area data, and Timer Completion Flags, timer present values, index registers, and data registers can be protected by turning ON the IOM Hold Bit in the Auxiliary Area, and by also setting the IOM Hold Bit to "Hold" in the PLC Setup.	
	Power OFF Detection Time Setting	The detection time for power interruptions can be set. AC power supply: 10 to 25 ms (variable) DC power supply: 2 to 5 ms (CJ1W-PD022) or 2 to 20 ms (CJ1W-PD025)	
	Power OFF Detection Delay Time	The detection of power interruptions can be delayed: 0 to 10 ms (Not supported by the CJ1W-PD022.)	
	Number of Power Interruptions Counter	The number of times power has been interrupted is counted.	
Function Blocks		Standard programming can be encapsulated as function blocks.	
	Languages in Function Block Definitions	Ladder programming or structured text	
Debugging	Online Editing	The program can be changed during operation (in MONITOR or PROGRAM mode), except for block programming areas.	
	Force-Set/Reset	Specified bits can be set or reset. A parameter can be set to enable force-setting/resetting bits in EM Area banks. Force-setting/resetting is enabled for the specified bank and all the banks after it. *8	
	Differentiate Monitoring	ON/OFF changes in specified bits can be monitored.	
	Data Tracing	The specified I/O memory data can be stored in the trace memory in the CPU Unit. The triggers can be set.	
	Continuous Tracing	The trace data can be uploaded during data tracing using CX-Programmer, which enables continuously logging the data by constantly uploading the trace data (trace data uploading during tracing).	
	Automatically starting tracing when operation starts	Data tracing can be automatically started when operation is started (i.e., when the operating mode is changed from PROGRAM mode to MONITOR or RUN mode).	
	Storing Location of Error when an Error Occurs	The location and task number where execution stopped for a program error is recorded.	
	Program Check	The programs can be checked for items such as no END instruction and FALS/FAL errors at startup.	
Self-diagnosis and Restoration	Error Log	A function is provided to store predefined error codes in CPU Unit, error information, and time at which the error occurred.	
	CPU Error Detection	CPU Unit WDT errors are detected.	
	User-defined Failure Diagnosis	Errors can be generated for user-specified conditions: Non-fatal errors (FAL) and fatal errors (FALS). Program section time diagnosis and program section logic diagnosis are supported (FPD instruction).	
	Load OFF Function	This function turns OFF all outputs from Output Units when an error occurs.	
	RUN Output	The RUN output from the CJ1W-PA205R turns ON while CPU Unit is in RUN mode or MONITOR mode.	
	Basic I/O Load Short-circuit Detection	This function provides alarm information from Basic I/O Units that have load short-circuit protection.	
	Failure Point Detection	The time and logic of an instruction block can be analyzed using the FPD instruction.	
	CPU Standby Detection	This function indicates when the CPU Unit is on standby because all Special I/O Units and CPU Bus Units have not been recognized at the startup in RUN or MONITOR mode.	
	Non-fatal Error Detection	System FAL Error Detection (User-defined non-fatal error)	This function generates a non-fatal (FAL) error when the user-defined conditions are met in program.
		Duplicated Refreshing Error Detection	This function detects an error when an immediate refreshing instruction in an interrupt task is competing with I/O refreshing of a cyclic task.
		Basic I/O Unit Error Detection	This function detects the errors in Basic I/O Units.
		Backup Memory Error Detection	This function detects errors in the memory backup of the user programs and parameter area (backup memory).
		PLC Setup Error Detection	This function detects setting errors in the PLC Setup.
		CPU Bus Unit Error Detection	This function detects an error when there is an error in data exchange between the CPU Unit and a CPU Bus Unit.
		Special I/O Unit Error Detection	This function detects an error when there is an error in data exchange between the CPU Unit and a Special I/O Unit.
		Tag Memory Error Detection *9	This function detects errors in tag memory.
Battery Error Detection		This function detects an error when a battery is not connected to the CPU Unit or when the battery voltage drops.	
CPU Bus Unit Setting Error Detection		This function detects an error when the model of a CPU Bus Unit in the registered I/O tables does not agree with the model that is actually mounted in the PLC.	
Special I/O Unit Setting Error Detection	This function detects an error when the model of a Special I/O Unit in the registered I/O tables does not agree with the model of Unit that is actually mounted.		
Option Board Error Detection *10	This function detects the errors in Serial Option Board mounting status.		

*8. Supported only by CJ2H CPU Units with unit version 1.2 or later and CJ2M CPU Units.

*9. Supported only by CJ2H-CPU6□-EIP and CJ2H-CPU3□.

*10. Supported only by CJ2M-CPU3□.

Functions		Description		
Self-diagnosis and Restoration (Continued from previous page)	Fatal Error Detection	Memory Error Detection	This function detects errors that occur in memory of the CPU Unit.	
		I/O Bus Error Detection	This function detects when an error occurs in data transfers between the Units mounted in Rack slots and the CPU Unit and detects when the End Cover is not connected to the CPU Rack or an Expansion Rack.	
		Unit/Rack Number Duplication Error	This function detects an error when the same unit number is set for two or more Units, the same word is allocated to two or more Basic I/O Units, or the same rack number is set for two or more Racks.	
		Too Many I/O Points Error Detection	This function detects an error when the total number of I/O points set in the I/O tables or the number of Units per Rack exceeds the specified range.	
		I/O Setting Error Detection	The registered I/O tables are used to detect errors if the number of Units in the registered I/O tables does not agree with the actual number of Units that are connected or an Interrupt Unit has been connected in the wrong position, i.e., not in the following slots. <ul style="list-style-type: none"> • CJ2H-CPU6□-EIP: Slots 0 to 3 • CJ2H-CPU6□: Slots 0 to 4 • CJ2M-CPU3□: Slots 0 to 4 • CJ2M-CPU1□: Slots 0 to 4 	
		Program Error Detection	This function detects errors in programs.	
		Instruction Processing Error Detection	This function detects an error when the given data value is invalid when executing an instruction, or execution of instruction between tasks was attempted.	
		Indirect DM/EM BCD Error Detection	This function detects an error when an indirect DM/EM address in BCD mode is not BCD.	
		Illegal Area Access Error Detection	This function detects an error when an attempt is made to access an illegal area with an instruction operand.	
		No END Error Detection	This function detects an error when there is no END instruction at the end of the program.	
		Task Error Detection	This function detects an error when there are no tasks that can be executed in a cycle, there is no program for a task, or the execution condition for an interrupt task was met but there is no interrupt task with the specified number.	
		Differentiation Overflow Error Detection	This function detects an error when too many differentiated instructions are entered or deleted during online editing (131,072 times or more).	
		Invalid Instruction Error Detection	This function detects an error when an attempt is made to execute an instruction that is not defined in the system.	
		User Program Area Overflow Error Detection	This function detects an error when instruction data is stored after the last address in user program area.	
		Maintenance	Memory Self-restoration Function	Cycle Time Exceeded Error Detection
System FALS Error Detection (User-defined Fatal Error)	This function generates a fatal (FALS) error when the user-defined conditions are met in program.			
Version Error Detection	This function detects an error when a user program includes a function that is not supported by the current unit version.			
Memory Card Transfer Error Detection	This function detects an error when the automatic file transfer from Memory Card fails at startup.			
Simple Backup Function	This function collectively backs up the data in CPU Unit (user programs, parameters, and I/O memory) and internal backup data in the I/O Units.			
Unsolicited Communications	A function that allows the PLC to use Network Communications Instruction to send required FINS commands to a computer connected via a Host Link			
Remote Programming and Monitoring	Host Link communications can be used for remote programming and remote monitoring through a Controller Link, Ethernet, DeviceNet, or SYSMAC LINK Network. Communications across network layers can be performed. Controller Link or Ethernet: 8 layers DeviceNet or SYSMAC LINK: 3 layers			
Automatic Online Connection via Network	Direct Serial Connection			This function enables automatically connecting to the PLC online when the CX-Programmer is directly connected by a serial connection (peripheral (USB) port or serial port).
	Via Networks			This function enables connecting the CX-Programmer online to a PLC that is connected via an EtherNet/IP network.
Security	Read Protection using Password			This function protects reading and displaying programs and tasks using passwords. Write protection: Set using the DIP switch. Read protection: Set a password using the CX-Programmer.
	FINS Write Protection			This function prohibits writing by using FINS commands sent over the network.
	Unit Name Function			This function allows the users to give any names to the Units. Names are verified at online connection to prevent wrong connection
	Hardware ID Using Lot Numbers			This function sets operation protection by identifying hardware using the user programs according to lot numbers stored in the Auxiliary Area.

*11. Supported only by CJ2H CPU Units.

■ Unit Versions

Units	Models	Unit Version
CJ2H CPU Unit	CJ2H-CPU6□-EIP	Unit version 1.0 (Built-in EtherNet/IP section: Unit version 2.0)
		Unit version 1.1 (Built-in EtherNet/IP section: Unit version 2.0)
		Unit version 1.2 (Built-in EtherNet/IP section: Unit version 2.0)
		Unit version 1.3 (Built-in EtherNet/IP section: Unit version 2.0)
		Unit version 1.4 (Built-in EtherNet/IP section: Unit version 2.□/Unit version 3.0)
	CJ2H-CPU6□	Unit version 1.1
		Unit version 1.2
		Unit version 1.3
		Unit version 1.4
CJ2M CPU Unit	CJ2M-CPU3□	Unit version 1.0 (Built-in EtherNet/IP section: Unit version 2.0)
		Unit version 2.0 (Built-in EtherNet/IP section: Unit version 2.0)
		Unit version 2.0 (Built-in EtherNet/IP section: Unit version 2.1)
	CJ2M-CPU1□	Unit version 1.0 Unit version 2.0

■ Unit Versions and Programming Devices

The following tables show the relationship between unit versions and CX-Programmer versions.

CPU Unit		Functions		Required Programming Device						Programming Console	
				CX-Programmer							
				Ver.7.1 or lower	Ver.8.0	Ver.8.2	Ver.9.0	Ver.9.1	Ver.9.12	Ver.9.3 or higher	
CJ2H	CJ2H-CPU6□-EIP Unit version 1.0	Functions for unit version 1.0		---	OK	OK	OK	OK	OK	OK	--- *3
	CJ2H-CPU6□-EIP Unit version 1.1	Functions added for unit version 1.1	Using new functions	---	---	OK *2	OK	OK	OK	OK	
			Not using new functions	---	OK *1	OK	OK	OK	OK	OK	
	CJ2H-CPU6□ Unit version 1.1	Functions added for unit version 1.1	Using new functions	---	---	OK *2	OK	OK	OK	OK	
			Not using new functions	---	---	OK	OK	OK	OK	OK	
	CJ2H-CPU6□-EIP Unit version 1.2	Functions added for unit version 1.2	Using new functions	---	---	---	OK	OK	OK	OK	
			Not using new functions	---	OK *1	OK *1	OK	OK	OK	OK	
	CJ2H-CPU6□ Unit version 1.2	Functions added for unit version 1.2	Using new functions	---	---	---	OK	OK	OK	OK	
			Not using new functions	---	OK *1	OK *1	OK	OK	OK	OK	
	CJ2H-CPU6□-EIP Unit version 1.3	Functions added for unit version 1.3	Using new functions	---	---	---	---	OK	OK	OK	
Not using new functions			---	OK *1	OK *1	OK	OK	OK	OK		
CJ2H-CPU6□ Unit version 1.3	Functions added for unit version 1.3	Using new functions	---	---	---	---	OK	OK	OK		
		Not using new functions	---	OK *1	OK *1	OK	OK	OK	OK		
CJ2H-CPU6□-EIP Unit version 1.4	Functions added for unit version 1.4	Using new functions	---	---	---	---	---	OK	OK		
		Not using new functions	---	OK *1	OK *1	OK	OK	OK	OK		
CJ2H-CPU6□ Unit version 1.4	Functions added for unit version 1.4	Using new functions	---	---	---	---	---	---	OK		
		Not using new functions	---	OK *1	OK *1	OK	OK	OK	OK		
CJ2M	CJ2M-CPU□□ Unit version 1.0	Functions for unit version 1.0		---	---	---	---	OK	OK	OK	
	CJ2M-CPU□□ Unit version 2.0	Functions added for unit version 2.0	Using new functions	---	---	---	---	---	OK	OK	
			Not using new functions	---	---	---	---	OK *1	OK	OK	

- *1. It is not necessary to upgrade the version of the CX-Programmer if functionality that was enhanced for the upgrade of the CPU Unit will not be used.
- *2. CX-Programmer version 8.2 or higher is required to use the functions added for unit version 1.1. The high-speed interrupt function and changing the minimum cycle time setting in MONITOR mode, however, are also supported by CX-Programmer version 8.02.
- *3. A Programming Console cannot be used with a CJ2 CPU Unit.

Specifications for Pulse I/O Functions

The following functions of CJ2M can be used by installing one or two Pulse I/O Module. Each module has 10 high-speed inputs and 6 high-speed outputs. Pulse I/O Modules can be installed on CJ2M CPU Units with Unit Version 2.0 or Later.

- The inputs can be used as general-purpose inputs, interrupt inputs, quick-response inputs, high-speed counters, or origin search inputs.
- The outputs can be used as general-purpose outputs, pulse outputs, origin search outputs, or PWM outputs.

One Pulse I/O Module can be mounted

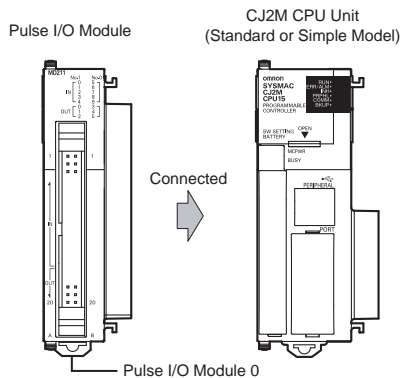

Two Pulse I/O Modules can be mounted

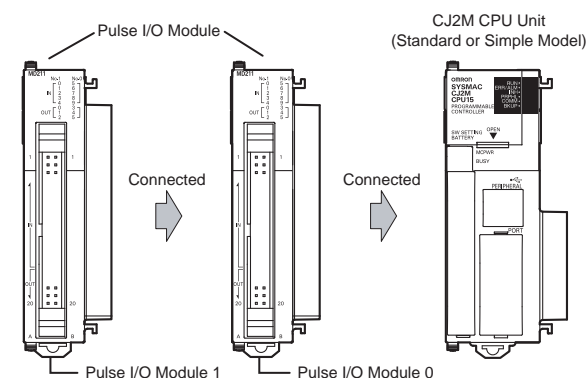

Note: The Pulse I/O Module closest to the CPU Unit is Pulse I/O Module 0 and the other one is Pulse I/O Module 1.

Performance Specifications

Item	Description
Model of Pulse I/O Modules	CJ2M-MD211 (Sinking-type) CJ2M-MD212 (Sourcing-type)
External interface	40-pin MIL connector
Pulse Inputs	Can be used as normal inputs, interrupt inputs, quick-response inputs, or high-speed counter inputs. (Function of each input must be selected in the PLC Setup.) Input method: Line-driver input or 24-VDC input (selected by via wiring)
Normal Inputs	20 max. (10 per Pulse I/O Module) Input constants: Set in the PLC Setup (0, 0.5, 1, 2, 4, 8, 16, or 32 ms). Default: 8 ms
Interrupt inputs and quick-response inputs	8 max. (4 per Pulse I/O Module) Input signal minimum ON pulse width: 30 μs
High-speed counter inputs	4 max. (2 per Pulse I/O Module) Input method: Differential-phase (×4) pulses, pulse + direction, up/down pulses, or increment pulse Maximum response frequency: 50 kHz for differential phases or 100 kHz for single phase Counting mode: Linear mode or circular (ring) mode Count value: 32 bits Counter reset: Phase Z + software reset or software reset Control method: Target-value comparison or range comparison Gate function: Supported
Pulse Outputs	Can be used as normal outputs, pulse outputs, or PWM outputs. (Function of each output must be selected in the PLC Setup.) Output method: Sinking or sourcing transistor outputs (The method is determined by Pulse I/O Module model.)
Normal Outputs	12 max. (6 per Pulse I/O Module)
Pulse Outputs	4 max. (2 per Pulse I/O Module) Output method: CW/CCW or pulse + direction (The method is determined by the I/O wiring and the instructions used in the ladder program.) Output frequency: 1 pps to 100 kpps (in increments of 1 pps) Output Mode: Continuous mode (for speed control) or independent mode (for position control) Output pulses: Relative coordinates: 0000 0000 to 7FFF FFFF hex (0 to 2,147,483,647 pulses) Absolute coordinates: 8000 0000 to 7FFF FFFF hex (-2,147,483,648 to 2,147,483,647) Acceleration/deceleration curves: Linear or S-curve Origin search function: Supported
PWM Outputs	4 max. (2 per Pulse I/O Module) Output frequency: 0.1 to 6,553.5 Hz (in 0.1-Hz increments) or 1 to 32,800 Hz (in 1-Hz increments) Duty ratio: 0.0% to 100.0% (in 0.1% increments)

Function Specifications

Functions	Description		
Pulse I/O Functions	Normal Inputs	Input signals are read during I/O refreshing and stored in I/O memory.	
	Pulse Input Functions	Interrupt Inputs	An interrupt task can be started when an input signal turns ON or turns OFF.
		Quick-response Inputs	Input signals that are shorter than the cycle time are read and stored in I/O memory.
		High-speed Counter Inputs	High-speed pulse signals are counted. Interrupt tasks can also be started.
	Pulse Output Functions	Normal Outputs	The status of I/O memory is output during I/O refreshing.
		Pulse Outputs	A pulse signal is output with the specified frequency and number of pulses at a fixed duty ratio (50%).
PWM Outputs		A pulse signal is output at the specified duty ratio.	
Origin Searches	The origin point of the machine is determined according to the specified origin search parameters while actually outputting pulses and using the origin and origin proximity input signals as conditions. (Pulse inputs and outputs are also used for this function.)		
Interrupt	Input Interrupt Function	A task is started for an interrupt input from a Pulse I/O Module or for a high-speed counter input.	
	Input Interrupts	Interrupt tasks are executed when the interrupt input turns ON or turns OFF. Direct Mode: An interrupt task is executed each time an input signal changes. Counter Mode: Changes in the input signal are counted up or down and the interrupt task is executed when the counter counts out. (The maximum response frequency is 3 kHz.)	
		High-speed Counter Interrupts	An interrupt task is executed when preset comparison conditions for a high-speed counter are met. Target-value comparison: The interrupt task is executed when the count matches a specified value. Range comparison: The interrupt task is executed when the count enters or leaves a specified range of values.

■Allocating Functions to I/O signals

Pulse I/O Module 0 (on the right)

Terminal symbol		IN 00	IN 01	IN 02	IN 03	IN 04	IN 05	IN 06	IN 07	IN 08	IN 09	OUT 00	OUT 01	OUT 02	OUT 03	OUT 04	OUT 05	
Address		2960											2961					
Bit		0	1	2	3	4	5	6	7	8	9	0	1	2	3	4	5	
Inputs	Normal inputs	Normal input 0	Normal input 1	Normal input 2	Normal input 3	Normal input 4	Normal input 5	Normal input 6	Normal input 7	Normal input 8	Normal input 9	---	---	---	---	---	---	
	Interrupt inputs (Direct Mode/Counter Mode)	Interrupt input 0	Interrupt input 1	Interrupt input 2	Interrupt input 3	---	---	---	---	---	---	---	---	---	---	---	---	
	Quick response inputs	Quick response input 0	Quick response input 1	Quick response input 2	Quick response input 3	---	---	---	---	---	---	---	---	---	---	---	---	
	High-speed counters	---	---	High-speed counter 1 (phase-Z/reset)	High-speed counter 0 (phase-Z/reset)	---	---	High-speed counter 1 (phase-A, increment, or count input)	High-speed counter 1 (phase-B, decrement, or direction input)	High-speed counter 0 (phase-A, increment, or count input)	High-speed counter 0 (phase-B, decrement, or direction input)	---	---	---	---	---	---	
Out-puts	Normal outputs	---	---	---	---	---	---	---	---	---	---	Normal output 0	Normal output 1	Normal output 2	Normal output 3	Normal output 4	Normal output 5	
	Pulse out-puts	CW/CCW outputs	---	---	---	---	---	---	---	---	---	---	Pulse output 0 (CW)	Pulse output 0 (CCW)	Pulse output 1 (CW)	Pulse output 1 (CCW)	---	---
		Pulse + direction outputs	---	---	---	---	---	---	---	---	---	---	Pulse output 0 (pulse)	Pulse output 1 (pulse)	Pulse output 0 (direction)	Pulse output 1 (direction)	---	---
		Variable duty ratio outputs	---	---	---	---	---	---	---	---	---	---	---	---	---	---	PWM output 0	PWM output 1
Origin search		Origin search 0 (Origin Input Signal)	Origin search 0 (Origin Proximity Input Signal)	Origin search 1 (Origin Input Signal)	Origin search 1 (Origin Proximity Input Signal)	Origin search 0 (Positioning Completed Signal)	Origin search 1 (Positioning Completed Signal)	---	---	---	---	---	---	---	---	---	Pulse output 0 error counter reset output (operation modes 1 and 2)	Pulse output 1 error counter reset output (operation modes 1 and 2)

Pulse I/O Module 1 (on the left)

Terminal symbol		IN 10	IN 11	IN 12	IN 13	IN 14	IN 15	IN 16	IN 17	IN 18	IN 19	OUT 10	OUT 11	OUT 12	OUT 13	OUT 14	OUT 15	
Address		2962											2963					
Bit		0	1	2	3	4	5	6	7	8	9	0	1	2	3	4	5	
Inputs	Normal inputs	Normal input 10	Normal input 11	Normal input 12	Normal input 13	Normal input 14	Normal input 15	Normal input 16	Normal input 17	Normal input 18	Normal input 19	---	---	---	---	---	---	
	Interrupt inputs (Direct Mode/Counter Mode)	Interrupt input 4	Interrupt input 5	Interrupt input 6	Interrupt input 7	---	---	---	---	---	---	---	---	---	---	---	---	
	Quick response inputs	Quick response input 4	Quick response input 5	Quick response input 6	Quick response input 7	---	---	---	---	---	---	---	---	---	---	---	---	
	High-speed counters	---	---	High-speed counter 3 (phase-Z/reset)	High-speed counter 2 (phase-Z/reset)	---	---	High-speed counter 3 (phase-A, increment, or count input)	High-speed counter 3 (phase-B, decrement, or direction input)	High-speed counter 2 (phase-A, increment, or count input)	High-speed counter 2 (phase-B, decrement, or direction input)	---	---	---	---	---	---	
Out-puts	Normal outputs	---	---	---	---	---	---	---	---	---	---	Normal output 6	Normal output 7	Normal output 8	Normal output 9	Normal output 10	Normal output 11	
	Pulse out-puts	CW/CCW outputs	---	---	---	---	---	---	---	---	---	---	Pulse output 2 (CW)	Pulse output 2 (CCW)	Pulse output 3 (CW)	Pulse output 3 (CCW)	---	---
		Pulse + direction outputs	---	---	---	---	---	---	---	---	---	---	Pulse output 2 (pulse)	Pulse output 3 (pulse)	Pulse output 2 (direction)	Pulse output 3 (direction)	---	---
		Variable duty ratio outputs	---	---	---	---	---	---	---	---	---	---	---	---	---	---	PWM output 2	PWM output 3
Origin search		Origin search 2 (Origin Input Signal)	Origin search 2 (Origin Proximity Input Signal)	Origin search 3 (Origin Input Signal)	Origin search 3 (Origin Proximity Input Signal)	Origin search 2 (Positioning Completed Signal)	Origin search 3 (Positioning Completed Signal)	---	---	---	---	---	---	---	---	---	Pulse output 2 error counter reset output (operation modes 1 and 2)	Pulse output 3 error counter reset output (operation modes 1 and 2)

■ Specifications of Pulse Input Functions

● Interrupt Inputs

Item	Direct Mode	Counter Mode
Number of interrupt inputs	Max. 8 inputs	
Allocated bit	CIO 2960 and CIO 2962, bits 00 to 03	
Interrupt detection method	ON-to-OFF or OFF-to-ON transitions	
Interrupt task numbers	140 to 147 (fixed)	
Counting method	---	Incrementing or decrementing (Set with the MSKS(690) instruction.)
Counting range	---	0001 to FFFF hex (16 bits) (Set in A532 to A535 and A544 to A547.)
Response frequency	---	Single-phase: 3 kHz x 8 inputs
Storage locations for PVs for interrupt inputs in Counter Mode	---	A536 to A539 and A548 to A551

● Quick-response inputs

Item	Specifications
Number of Quick-response inputs	Max. 8 inputs
Quick-response inputs	Signals that are shorter than the cycle time are latched for one PLC cycle, so they can be detected in the PLC program. Minimum detectable pulse width is 30 μs.

● High-speed Counter Inputs

Item	Description			
Number of High-speed Counter Inputs	Max. 4 inputs			
Pulse input method (counting mode)	Incremental pulse inputs	Differential phase input (4×)	Up/down inputs	Pulse + direction inputs
Input signals	Increment pulse	Phase A	Up pulse	Pulse
	---	Phase B	Down pulse	Direction
	---	Phase Z	Reset	Reset
Frequency and number of high-speed counters	100 kHz, 2 inputs × 2 I/O Modules	50 kHz, 2 inputs × 2 I/O Modules	100 kHz, 2 inputs × 2 I/O Modules	100 kHz, 2 inputs × 2 I/O Modules
Counting mode	Linear mode or ring mode			
Count value	Linear mode: 8000 0000 to 7FFF FFFF hex 0000 0000 to FFFF FFFF hex (for increment pulse) Ring mode: 0000 0000 to Max. ring value			
High-speed counter PV storage locations	High-speed counter 0: A271 (upper 4 digits) and A270 (lower 4 digits) High-speed counter 1: A273 (upper 4 digits) and A272 (lower 4 digits) High-speed counter 2: A317 (upper 4 digits) and A316 (lower 4 digits) High-speed counter 3: A319 (upper 4 digits) and A318 (lower 4 digits) Refreshed during overseeing processing. Use PRV(881) to read the most recent PVs.			
	Data format: 8 digit hexadecimal • Linear mode: 8000 0000 to 7FFF FFFF hex 0000 0000 to FFFF FFFF hex (for increment pulse) • Ring mode: 0000 0000 to Max. ring value			
Control method	Target value comparison	Up to 48 target values and corresponding interrupt task numbers can be registered.		
	Range Comparison	Up to 8 or up to 32 ranges can be registered, with a separate upper limit, lower limit, and interrupt task number for each range.		
Counter reset method	<ul style="list-style-type: none"> Phase-Z + Software reset The counter is reset when the phase-Z input goes ON while the Reset Bit (A531.00 to A531.03) is ON. Software reset The counter is reset when the Reset Bit (A531.00 to A531.03) is turned ON. Operation can be set to stop or continue the comparison operation when the high-speed counter is reset. 			

■ Specifications of Pulse Output Functions

● Position Control and Speed Control

Item	Specifications
Number of Pulse Outputs	Max. 4 outputs (Pulse Output 00 to 03)
Output mode	Continuous mode (for speed control) or independent mode (for position control)
Positioning (independent mode) instructions	PULS (886) and SPED (885), PULS (886) and ACC (888), or PULS2 (887) instruction
Speed control (continuous mode) instructions	SPED(885) and ACC (888) instructions
Origin (origin search and origin return) instructions	ORG (889) instruction
Interrupt feeding instruction	IFEED (892) instruction
Output frequency	1 pps to 100 kpps (1 pps units), two pulse outputs × 2 Pulse I/O Modules
Frequency acceleration and deceleration rates	Set in increments of 1 pps for acceleration/deceleration rates from 1 to 65,535 pps (every 4 ms). The acceleration and deceleration rates can be set independently only with the PLS2 (887) instruction.
Changing SVs during instruction execution	The target frequency, acceleration/deceleration rate, and target position can be changed.
Pulse output method	CW/CCW or pulse + direction
Number of output pulses	Relative coordinates: 0000 0000 to 7FFF FFFF hex (Accelerating or decelerating in either direction: 2,147,483,647) Absolute coordinates: 8000 0000 to 7FFF FFFF hex (-2,147,483,648 to 2,147,483,647)
Relative/absolute coordinate specifications for pulse output PVs	Absolute coordinates are specified automatically when the origin location has been defined by changing the pulse output PV with the INI (880) instruction or performing an origin search with the ORG(889) instruction. Relative coordinates must be used when the origin is undefined.
Relative pulse/absolute pulse specifications	The pulse type can be specified with an operand in the PULS (886) or PLS2 (887) instruction. Absolute pulses can be used when absolute coordinates are specified for the pulse output PV, i.e. the origin location has been defined. Absolute pulse cannot be used when relative coordinates are specified, i.e., when the origin location is undefined. An instruction error will occur.
Pulse output PV's storage location	The following Auxiliary Area words contain the pulse output PVs Pulse output 0: A277 (leftmost 4 digits) and A276 (rightmost 4 digits) Pulse output 1: A279 (leftmost 4 digits) and A278 (rightmost 4 digits) Pulse output 2: A323 (leftmost 4 digits) and A322 (rightmost 4 digits) Pulse output 3: A325 (leftmost 4 digits) and A324 (rightmost 4 digits) The PVs are refreshed during regular I/O refreshing.

● Variable-duty Pulse Outputs (PWM)

Item	Specifications
Number of PWM Outputs	Max. 4 outputs (PWM Output 00 to 03)
Duty ratio	0.0% to 100.0% in 0.1% increments
Frequency	0.1 Hz to 6,553.5 Hz (Set in 0.1-Hz increments.) 1 Hz to 32,800 Hz (Set in 1-Hz increments.)
Output mode	Continuous Mode
Instruction	PWM (891) instruction

■ Specifications of Pulse I/O Modules

● Input Specifications (IN00 to IN09/IN10 to IN19)

Normal Inputs

Inputs	IN00 to IN05 and IN10 to IN15	IN06 to IN09 and IN16 to IN19	IN00 to IN05 and IN10 to IN15	IN06 to IN09 and IN16 to IN19
Input form	24-VDC inputs		Line driver inputs	
Input current	6.0 mA typical	5.5 mA typical	13 mA typical	10 mA typical
Input voltage range	24 VDC +10%/–15%		RS-422A or RS-422 line driver (conforming to AM26LS31), Power supply voltage of 5 V ± 5%	
Input impedance	3.6 kΩ	4.0 kΩ	---	
Number of circuits	1 common, 1 circuit			
ON voltage/current	17.4 VDC min., 3 mA min.		---	
OFF voltage/current	1 mA max. at 5 VDC max.		---	
ON response time	8 ms max. (The input time constant can be set to 0, 0.5, 1, 2, 4, 8, 16, or 32 ms in the PLC Setup.)			
OFF response time	8 ms max. (The input time constant can be set to 0, 0.5, 1, 2, 4, 8, 16, or 32 ms in the PLC Setup.)			

Input Circuit Configuration

Item	Specifications	
Input	IN00 to IN05/IN10 to IN15	IN06 to IN09/IN16 to IN19
Circuit configuration		

Interrupt Input and Quick-response Input Specifications (IN00 to IN03 and IN10 to IN13)

Item	Specifications
ON response time	30 μs max.
OFF response time	150 μs max.
Response pulse	

High-speed Counter Input Specifications (IN06 to IN09 and IN16 to IN19)

	24-VDC input	Line driver input
Set to 60 kHz	<p>Phase-A/Phase-B encoder input, Single-phase 60-kHz pulse input with 50% duty ratio</p> <p>Rise time and fall time: 3.0 μs max. 16.6 μs min.</p> <p>ON 50% OFF</p> <p>8.3 μs min. 8.3 μs min.</p> <p>3 μs max. 3 μs max.</p>	<p>Encoder input phase A or B, single-phase 60-kHz pulse input with 50% duty ratio</p> <p>ON 50% OFF</p> <p>16.6 μs min.</p> <p>8.3 μs min. 8.3 μs min.</p>
	<p>Phase-A/Phase-B encoder inputs, Differential phases, 30 kHz</p> <p>Changes in phases A and B must be separated by at least 4.0 μs.</p> <p>ON 50% OFF ON 50% OFF</p> <p>33.3 μs min.</p> <p>T1 T2 T3 T4 T1, T2, T3, T4: 4.0 μs min.</p>	<p>Phase-A/Phase-B encoder inputs, Differential phases, 30 kHz</p> <p>Changes in phases A and B must be separated by at least 4.0 μs.</p> <p>ON 50% OFF ON 50% OFF</p> <p>33.3 μs min.</p> <p>T1 T2 T3 T4 T1, T2, T3, T4: 4.0 μs min.</p>
Set to 100 kHz	<p>Phase-A/Phase-B encoder input, Single-phase 100-kHz pulse input with 50% duty ratio</p> <p>Rise time and fall time: 2.5 μs max. 10.0 μs min.</p> <p>ON 50% OFF</p> <p>5.0 μs min. 5.0 μs min.</p> <p>2.5 μs max. 2.5 μs max.</p>	<p>Single-phase 100-kHz pulse input with 50% duty ratio</p> <p>ON 50% OFF</p> <p>10.0 μs min.</p> <p>5.0 μs min. 5.0 μs min.</p>
	<p>Phase-A/Phase-B encoder inputs, Differential phases, 50 kHz</p> <p>Changes in phases A and B must be separated by at least 2.5 μs.</p> <p>ON 50% OFF ON 50% OFF</p> <p>20.0 μs min.</p> <p>T1 T2 T3 T4 T1, T2, T3, T4: 2.5 μs min.</p>	<p>Differential-phase 50-kHz pulse input</p> <p>Changes in phases A and B must be separated by at least 2.5 μs.</p> <p>ON 50% OFF ON 50% OFF</p> <p>20.0 μs min.</p> <p>T1 T2 T3 T4 T1, T2, T3, T4: 2.5 μs min.</p>
Phase Z/reset input	<p>Encoder input phase Z (IN02/IN03 or IN12/IN13)</p> <p>Maintain an ON time of 30 μs min. and an OFF time of 150 μs min.</p> <p>ON 50% OFF</p> <p>30 μs min. 150 μs min.</p>	<p>Encoder input phase Z (IN02/IN03 or IN12/IN13)</p> <p>Maintain an ON time of 30 μs min. and an OFF time of 150 μs min.</p> <p>ON 50% OFF</p> <p>30 μs min. 150 μs min.</p>

Output Specifications (OUT00 to OUT05 and OUT10 to OUT15)

Item	Specifications	
	Sinking-type (CJ2M-MD211)	Sourcing-type (CJ2M-MD212)
Output Specifications	Sinking-type (CJ2M-MD211)	Sourcing-type (CJ2M-MD212)
Rated voltage	5 to 24 VDC	
Allowable voltage range	4.75 to 26.4 VDC	
Maximum switching current	0.3 A/output, 1.8 A/Unit	
Number of circuits	6 outputs (6 outputs/common)	
Maximum inrush current	3.0 A/output, 10 ms max.	2.0 A/output, 10 ms max.
Leakage current	0.1 mA max.	
Residual voltage	0.6 V max.	
ON response time	0.1 ms max.	
OFF response time	0.1 ms max.	
Fuse	None	
External supply power (power supply input for outputs)	10.2 to 26.4 VDC, 20 mA min.	
Circuit configuration		

Pulse Outputs (OUT00 to OUT03 and OUT10 to OUT13)

Item	Specifications	
	Sinking-type (CJ2M-MD211)	Sourcing-type (CJ2M-MD212)
Output Specifications	Sinking-type (CJ2M-MD211)	Sourcing-type (CJ2M-MD212)
Rated voltage	5 to 24 VDC	
Allowable voltage range	4.75 to 26.4 VDC	
Maximum switching capacity	30 mA	
Minimum switching capacity	7 mA	
Maximum output frequency	100 kHz	
Output waveform		

PWM Outputs (OUT04, OUT05, OUT14, and OUT15)

Item	Specifications	
	Sinking-type (CJ2M-MD211)	Sourcing-type (CJ2M-MD212)
Output Specifications	Sinking-type (CJ2M-MD211)	Sourcing-type (CJ2M-MD212)
Rated voltage	5 to 24 VDC	
Allowable voltage range	4.75 to 26.4 VDC	
Maximum switching capacity	6.5535 kHz or less: 300 mA, 6.5535 to 32.8 kHz: 100 mA	
Maximum output frequency	32,800 Hz	
PWM output accuracy (for ON pulse width of 2 μs or longer)	ON duty at 6.5535 kHz or less: -0.2% to +1%, ON duty at 32.8 kHz: -1% to +5% (at switching current of 30 mA)	ON duty at 6.5535 kHz or less: ±0.5%, ON duty at 32.8 kHz: ±2.5% (at switching current of 30 mA)
Output waveform		

Ordering Information

Basic Configuration Units	32
Programming Devices.....	37
Programming Device Connecting Cable.....	38
FA Communications Software.....	39
Optional Products and Maintenance Products	40
DIN Track Accessories	40
Basic I/O Units	41
Special I/O Units and CPU Bus Units.....	47

International Standards

- The standards are abbreviated as follows: U: UL, U1: UL (Class I Division 2 Products for Hazardous Locations), C: CSA, UC: cULus, UC1: cULus (Class I Division 2 Products for Hazardous Locations), CU: cUL, N: NK, L: Lloyd, CE: EC Directives, and KC: KC Registration.
- Contact your OMRON representative for further details and applicable conditions for these standards.
- Refer to the OMRON website (www.ia.omron.com) or ask your OMRON representative for the most recent applicable standards for each model.

● EC Directives

The EC Directives applicable to PLCs include the EMC Directives and the Low Voltage Directive. OMRON complies with these directives as described below.

- EMC Directives
Applicable Standards
EMI: EN61000-6-4, EN61131-2
EMS: EN61000-6-2, EN61131-2

PLCs are electrical devices that are incorporated in machines and manufacturing installations. OMRON PLCs conform to the related EMC standards so that the devices and machines into which they are built can more easily conform to EMC standards. The actual PLCs have been checked for conformity to EMC standards. Whether these

standards are satisfied for the actual system, however, must be checked by the customer.

EMC-related performance will vary depending on the configuration, wiring, and other conditions of the equipment or control panel in which the PLC is installed. The customer must, therefore, perform final checks to confirm that the overall machine or device conforms to EMC standards.

● Low Voltage Directive

Applicable Standard: EN61131-2

VDC must satisfy the appropriate safety requirements. With PLCs, this applies to Power Supply Units and I/O Units that operate in these voltage ranges.

These Units have been designed to conform to EN61131-2, which is the applicable standard for PLCs.

Ordering Information

Basic Configuration Units

CPU Units

■ CJ2H (Built-in EtherNet/IP) CPU Units

Product name	Specifications				Current consumption (A)		Model	Standards
	I/O capacity/ Mountable Units (Expansion Racks)	Program capacity	Data memory capacity	LD instruction execution time	5 V	24 V		
CJ2H (Built-in EtherNet/IP) CPU Units 	2,560 points/ 40 Units (3 Expansion Racks max.)	400K steps	832K words (DM: 32K words, EM: 32K words × 25 banks)	0.016 μs	0.82 (See note.)	---	CJ2H-CPU68-EIP	UC1, N, L, CE
		250K steps	512K words (DM: 32K words, EM: 32K words × 15 banks)				CJ2H-CPU67-EIP	
		150K steps	352K words (DM: 32K words, EM: 32K words × 10 banks)				CJ2H-CPU66-EIP	
		100K steps	160K words (DM: 32K words, EM: 32K words × 4 bank)				CJ2H-CPU65-EIP	
		50K steps	160K words (DM: 32K words, EM: 32K words × 4 bank)				CJ2H-CPU64-EIP	

Note: Add 0.15 A per Adapter when using NT-AL001 RS-232C/RS-222A Adapters.
 Add 0.04 A per Adapter when using CJ1W-CIF11 RS-422A Adapters.
 Add 0.20A/Unit when using NV3W-M□20L(-V1) Programmable Terminals.

■ CJ2H CPU Units

Product name	Specifications				Current consumption (A)		Model	Standards
	I/O capacity/ Mountable Units (Expansion Racks)	Program capacity	Data memory capacity	LD instruction execution time	5 V	24 V		
CJ2H CPU Units 	2,560 points/ 40 Units (3 Expansion Racks max.)	400K steps	832K words (DM: 32K words, EM: 32K words × 25 banks)	0.016 μs	0.42 (See note.)	---	CJ2H-CPU68	UC1, N, L, CE
		250K steps	512K words (DM: 32K words, EM: 32K words × 15 banks)				CJ2H-CPU67	
		150K steps	352K words (DM: 32K words, EM: 32K words × 10 banks)				CJ2H-CPU66	
		100K steps	160K words (DM: 32K words, EM: 32K words × 4 bank)				CJ2H-CPU65	
		50K steps	160K words (DM: 32K words, EM: 32K words × 4 bank)				CJ2H-CPU64	

Note: Add 0.15 A per Adapter when using NT-AL001 RS-232C/RS-222A Adapters.
 Add 0.04 A per Adapter when using CJ1W-CIF11 RS-422A Adapters.
 Add 0.20A/Unit when using NV3W-M□20L(-V1) Programmable Terminals.

■ CJ2M CPU Units (Built-in EtherNet/IP)

Product name	Specifications						Current consumption (A)		Model	Standards
	I/O capacity/ Mountable Units (Expansion Racks)	Program capacity	Data memory capacity	LD instruction execution time	EtherNet/IP function	Option board slot	5 V	24 V		
CJ2M (Built-in EtherNet/IP) CPU Units 	2,560 points/ 40 Units (3 Expansion Racks max.)	60K steps	160K words (DM: 32K words, EM: 32K words × 4 banks)	0.04 μs	YES	YES	0.7 (See note.)	---	CJ2M-CPU35	UC1, N, L, CE
		30K steps							CJ2M-CPU34	
		20K steps	64K words (DM: 32K words, EM: 32K words × 1 bank)						CJ2M-CPU33	
		10K steps							CJ2M-CPU32	
		5K steps							CJ2M-CPU31	

Note: Add 0.005A, 0.030A, and 0.075A when using Serial Communications Option Boards (CP1W-CIF01/CIF11/CIF12-V1), respectively.
 Add 0.15A/Unit when using NT-AL001 RS-232C/RS-422A Adapters.
 Add 0.04A/Unit when using CJ1W-CIF11 RS-422A Adapters.
 Add 0.20A/Unit when using NV3W-M□20L(-V1) Programmable Terminals.

■ CJ2M CPU Units

Product name	Specifications						Current consumption (A)		Model	Standards
	I/O capacity/ Mountable Units (Expansion Racks)	Program capacity	Data memory capacity	LD instruction execution time	EtherNet/IP function	Option board slot	5 V	24 V		
CJ2M CPU Units 	2,560 points/ 40 Units (3 Expansion Racks max.)	60K steps	160K words (DM: 32K words, EM: 32K words × 4 banks)	0.04 μs	---	---	0.5 (See note.)	---	CJ2M-CPU15	UC1, N, L, CE
		30K steps							CJ2M-CPU14	
		20K steps	64K words (DM: 32K words, EM: 32K words × 1 bank)						CJ2M-CPU13	
		10K steps							CJ2M-CPU12	
		5K steps							CJ2M-CPU11	

Note: Add 0.15A/Unit when using NT-AL001 RS-232C/RS-422A Adapters.
 Add 0.04A/Unit when using CJ1W-CIF11 RS-422A Adapters.
 Add 0.20A/Unit when using NV3W-M□20L(-V1) Programmable Terminals.



The following accessories are included with the CPU Unit.

Item	Specifications
Battery	CJ1W-BAT01
End Cover	CJ1W-TER01 (The End Cover must be connected to the right end of the CPU Rack.)
End Plate	PFP-M (2 stoppers)

Note: A serial port (RS-232C) connector is not provided. Purchase a connector separately for serial port connection.
 Plug : XM3A-0921 (manufactured by OMRON) or equivalent
 Hood : XM2S-0911-E (manufactured by OMRON) or equivalent

■ Serial Communications Option Boards (Only CJ2M-CPU3□)

The serial communications port can be equipped by installing the serial communications option board to the option board slot in front of CPU unit.

Product name	Specifications	Serial communications mode	Current consumption (A)		Model	Standards
			5 V	24 V		
RS-232C Option Board 	One RS-232C port Connector: D-Sub, 9 pin, female Maximum transmission distance: 15m	Host Link, 1:N NT Link, Noprotocol, Serial PLC Link Slave, Serial PLC Link Master, Serial Gateway converted to CompoWay/F, and Tool Bus *	0.005	---	CP1W-CIF01	UC1, N, L, CE
RS-422A/485 Option Board 	One RS-422A/485 port Terminal block: using ferrules Maximum transmission distance: 50m		0.030	---	CP1W-CIF11	
RS-422A/485 Isolated-type Option Board 	One RS-422A/485 port (Isolated) Terminal block: using ferrules Maximum transmission distance: 500m		0.075	---	CP1W-CIF12-V1	

Note: It is not possible to use a CP-series Ethernet Option Board (CP1W-CIF41), LCD Option Board (CP1W-DAM01) with a CJ2M CPU Unit.
 * The following modes cannot be used: 1:1 NT Link, Serial Gateway converted to Host Link FINS, 1:1 Link Master, and 1:1 Link Slave.

■Pulse I/O Modules (Only CJ2M CPU Unit with Unit Version 2.0 or Later)



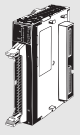





Optional Pulse I/O Modules can be mounted to enable pulse I/O. Up to two Pulse I/O Modules can be mounted to the left side of a CJ2M CPU Unit.

Product name	Specifications	Current consumption (A)		Model	Standards
		5 V	24 V		
 Pulse I/O Module	Sinking outputs, MIL connector 10 inputs (including four interrupt/quickresponse inputs and two high-speed counter inputs) 6 outputs (including two pulse outputs and two PWM outputs)	0.08	---	CJ2M-MD211	UC1, N, L, CE
	Sourcing outputs, MIL connector 10 inputs (including four interrupt/quickresponse inputs and two high-speed counter inputs) 6 outputs (including two pulse outputs and two PWM outputs)	0.08	---	CJ2M-MD212	

Note: Connectors are not provided with Pulse I/O Modules. Purchase the following Connector, an OMRON Cable with Connectors for Connector Terminal Block Conversion Units, or an OMRON Cable with Connectors for Servo Relay Units.

■Connecting to Pulse I/O Modules

On wiring, refer to Pulse I/O Modules Connector Wiring Methods.

Product name	Specifications	Model	Standards
Applicable Connector	MIL Flat Cable Connectors *1 	40-pin Pressure-welded Connectors	XG4M-4030-T
	MIL Loose Wire Connectors *2 	40-pin Crimped Connectors	XG5N-401 *4
	Crimp Contacts for XG5N *3 	Loose contacts	XG5W-0232
		Reel contacts	XG5W-0232-R
Manual Crimping Tool for XG5N 		XY2B-7007	
Connector-Terminal Block Conversion Units	Phillips screw (M3 screw terminals, 40-terminals) 		XW2R-J40G-T
	Slotted screw (M3 European type, 40-terminals) 		XW2R-E40G-T
	Push-in spring (Clamp 40-terminals) 		XW2R-P40G-T
Cable for Connector-Terminal Block Conversion Unit		Cable length: 0.25 m	XW2Z-C25K
		Cable length: 0.5 m	XW2Z-C50K
		Cable length: 1 m	XW2Z-100K
		Cable length: 1.5 m	XW2Z-150K
		Cable length: 2 m	XW2Z-200K
		Cable length: 3 m	XW2Z-300K
		Cable length: 5 m	XW2Z-500K

Note: Minimum ordering quantity for loose contacts is 100 pieces and for reel contacts is 1 reel (10,000 pieces).





*1. Socket and Strain Relief set

*2. Crimp Contacts (XG5W-0232) are sold separately.

*3. Applicable wire size is 28 to 24 AWG.

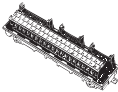
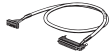
For applicable conductor construction and more information, visit the OMRON website at www.ia.omron.com.

*4. Crimp Contacts are also required.

Product name	Specifications			Model	Standards
Servo Relay Units	Servo Relay Unit for 1 axis 			XW2B-20J6-8A	
	Servo Relay Unit for 2 axes 			XW2B-40J6-9A	---
Cables for Servo Relay Units	G5/G Series	Cable for Pulse I/O Modules 	Cable length: 0.5 m	XW2Z-050J-A33	---
		Cable length: 1 m	XW2Z-100J-A33		
		Servo Driver Connecting Cables 	Cable length: 1 m	XW2Z-100J-B31	
		Cable length: 2 m	XW2Z-200J-B31		
	SMARTSTEP2	Cable for Pulse I/O Modules 	Cable length: 0.5 m	XW2Z-050J-A33	
		Cable length: 1 m	XW2Z-100J-A33		
		Servo Driver Connecting Cables 	Cable length: 1 m	XW2Z-100J-B32	
		Cable length: 2 m	XW2Z-200J-B32		

■ Power Supply Units

One Power Supply Unit is required for each Rack.

Product name	Power supply voltage	Output capacity			Options			Model	Standards
		5-VDC output capacity	24-VDC output capacity	Total power consumption	24-VDC service power supply	RUN output	Maintenance forecast monitor		
 AC Power Supply Unit	100 to 240 VAC	5 A	0.8 A	25 W	No	No	Yes	CJ1W-PA205C	UC1, N, L, CE
						Yes	No	CJ1W-PA205R	
		2.8 A	0.4 A	14 W		No	No	No	
 DC Power Supply Unit	24 VDC	5 A	0.8 A	25 W	No	No	CJ1W-PD025	UC1, CE	
		2 A	0.4 A	19.6 W	No	No	CJ1W-PD022		

Expansion Racks

Select the I/O Control Unit, I/O Interface Unit, Expansion Connecting Cable, and CJ-series Power Supply Unit.

■ CJ-series I/O Control Unit (Mounted on CPU Rack when Connecting Expansion Racks)

Product name	Specifications	Current consumption (A)		Model	Standards
		5 V	24 V		
 CJ-series I/O Control Unit	Mount one I/O Control Unit on the CJ-series CPU Rack when connecting one or more CJ-series Expansion Racks. Connecting Cable: CS1W-CN□□3 Expansion Connecting Cable Connected Unit: CJ1W-II101 I/O Interface Unit Mount to the right of the CPU Unit.	0.02	---	CJ1W-IC101	UC1, N, L, CE

Note: Mounting the I/O Control Unit in any other location may cause faulty operation.

■ CJ-series I/O Interface Unit (Mounted on Expansion Rack)

Product Name	Specifications	Current consumption (A)		Model	Standards
		5 V	24 V		
 CJ-series I/O Interface Unit	One I/O Interface Unit is required on each Expansion Rack. Connecting Cable: CS1W-CN□□3 Expansion Connecting Cable Mount to the right of the Power Supply Unit.	0.13	---	CJ1W-II101	UC1, N, L, CE

Note: Mounting the I/O Interface Unit in any other location may cause faulty operation.

■ I/O Connecting Cables

Product name	Specifications	Model	Standards
 I/O Connecting Cable	<ul style="list-style-type: none"> Connects an I/O Control Unit on CJ-series CPU Rack to an I/O Interface Unit on a CJ-series Expansion Rack. or Connects an I/O Interface Unit on CJ-series Expansion Rack to an I/O Interface Unit on another CJ-series Expansion Rack. 	Cable length: 0.3 m	CS1W-CN313
		Cable length: 0.7 m	CS1W-CN713
		Cable length: 2 m	CS1W-CN223
		Cable length: 3 m	CS1W-CN323
		Cable length: 5 m	CS1W-CN523
		Cable length: 10 m	CS1W-CN133
		Cable length: 12 m	CS1W-CN133-B2
			N, L, CE

Programming Devices

Support Software

Product name	Specifications	Media		Model	Standards
		Number of licenses			
FA Integrated Tool Package CX-One Ver. 4.□	The CX-One is a comprehensive software package that integrates Support Software for OMRON PLCs and components. CX-One runs on the following OS. Windows 7 (32-bit/64-bit version) / Windows 8(32-bit/64-bit version)/ Windows 8.1(32-bit/64-bit version) / Windows 10(32-bit/64-bit version) CX-One Version 4.□ includes CX-Programmer and CX-Simulator. For details, refer to the CX-One catalog (Cat. No. R134).	-(Media only) *	DVD	CXONE-AL00D-V4	---
		1 license		CXONE-AL01D-V4	
		3 licenses		CXONE-AL03D-V4	
		10 licenses		CXONE-AL10D-V4	
		30 licenses		CXONE-AL30D-V4	
		50 licenses		CXONE-AL50D-V4	

Note: Site licenses are available for users who will run CX-One on multiple computers. Ask your OMRON sales representative for details.

* The CXONE-AL00D-V4 contains only the DVD installation media for users who have purchased the CX-One Version 4.□ and does not include the license number. Enter the license number of the CX-One Version 4.□ when installing. (The license number of the CX-One Version 3.□ or lower cannot be used for installation.)

Support Software in CX-One Ver.4.□

The following tables lists the Support Software that can be installed from CX-One.

Support Software in CX-One	Outline
CX-Programmer	Application software to create and debug programs for CS/CJ/CP/NSJ-series, C-series, and CVM1/C-series CPU Units. Data can be created and monitored for high-speed-type Position Control Units and Position Control Units with EtherCAT interface.
CX-Integrator	Application software to build and set up FA networks, such as Controller Link, DeviceNet, CompoNet, CompoWay, and Ethernet networks. The Routing Table Component and Data Link Component can be started from here. DeviceNet Configuration functionality is also included.
Switch Box Utility	Utility software that helps you to debug PLCs. It helps you to monitor the I/O status and to monitor/change present values within the PLC you specify.
CX-Protocol	Application software to create protocols (communications sequences) between CS/CJ/CP/NSJ-series or C200HX/HG/HE Serial Communications Boards/Units and general-purpose external devices.
CX-Simulator	Application software to simulate CS/CJ/CP/NSJ-series CPU Unit operation on the computer to debug PLC programs without a CPU Unit.
CX-Position	Application software to create and monitor data for CS/CJ-series Position Control Units. (except for High-speed type)
CX-Motion-NCF	Application software to create and monitor data for CS/CJ-series Position Control Units with MECHATROLINK-II interface (NC□71).
CX-Motion-MCH	Application software to create data and monitor program and monitor data CS/CJ-series Motion Control Units with MECHATROLINK-II interface (MCH71).
CX-Motion	Application software to create data for CS/CJ-series, C200HX/HG/HE, and CVM1/CV-series Motion Control Units, and to create and monitor motion control programs.
CX-Drive	Application software to set and control data for Inverters and Servos.
CX-Process Tool	Application software to create and debug function block programs for CS/CJ-series Loop Controllers (Loop Control Units/Boards, Process Control CPU Units, and Loop Control CPU Units).
Faceplate Auto-Builder for NS	Application software that automatically outputs screen data as project files for NS-series PTs from tag information in function block programs created with the CX-Process Tool.
CX-Designer	Application software to create screen data for NS-series PTs.
NV-Designer	Application software to create screen data for NV-series small PTs.
CX-Configurator FDT	Application software for setting various units by installing its DTM module.
CX-Thermo	Application software to set and control parameters in components such as Temperature Control Units.
CX-FLnet	Application software for system setting and monitoring of CS/CJ-series FL-net Units
Network Configurator	Application software for set up and monitor tag datalink for CJ2 (Built-in EtherNet/IP) CPU Units and EtherNet/IP Units.
CX-Server	Middleware necessary for CX-One applications to communicate with OMRON components, such as PLCs, Display Devices, and Temperature Control Units.
Communications Middleware	Middleware necessary to communicate with CP1L CPU Units with built-in Ethernet port.
PLC Tools	A group of components used with CX-One applications, such as the CX-Programmer and CX-Integrator. Includes the following: I/O tables, PLC memory, PLC Setup, Data Tracing/Time Chart Monitoring, PLC Error Logs, File Memory, PLC clock, Routing Tables, and Data Link Tables.

Note: If the complete CX-One package is installed, approximately 4.0 GB of Hard disk space will be required.

Programming Device Connecting Cable

■Peripheral (USB) Port

Use commercially available USB cable.



Specifications: USB 1.1 or 2.0 cable (A connector - B connector), 5.0 m max.

■EtherNet/IP Port

Support Software can also be connected via the built-in EtherNet/IP port. Use commercially available 100Base-TX twisted-pair cable with the same specifications as for an EtherNet/IP Unit.

Specifications: Twisted-pair cable with RJ45 modular connectors at both ends. Connect between EtherNet/IP Unit or built-in EtherNet/IP port and switching hub. Use STP (shielded twisted-pair) cable of category 5 or 5e.

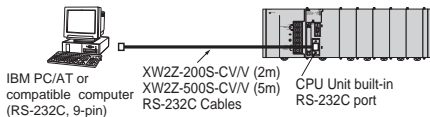
■ Serial Port

Product Name	Specifications				Model	Standards
	Applicable computers	Connection configuration	Cable length	Remarks		
Programming Device Connecting Cables for RS-232C Port 	Connects IBM PC/AT or compatible computers, D-Sub 9-pin	IBM PC/AT or compatible computer + XW2Z-200S-CV/V or XW2Z-500S-CV/V + RS-232C port of CPU Unit or Serial Communications Board or Unit	2 m	Used for Peripheral Bus or Host Link. Anti-static connectors	XW2Z-200S-CV	---
			5 m		XW2Z-500S-CV	
			2 m	Used for Host Link only. Peripheral Bus not supported.	XW2Z-200S-V	
			5 m		XW2Z-500S-V	
USB-Serial Conversion Cable and PC driver (on a CD-ROM disk)  Complies with USB Specification 2.0	IBM PC/AT or compatible computer (USB port)	IBM PC/AT or compatible computer + CS1W-CIF31 + XW2Z-200S-CV/500S-CV + RS-232C port of CPU Unit or Serial Communications Unit	0.5 m	Used for Peripheral Bus or Host Link.	CS1W-CIF31	N
		IBM PC/AT or compatible computer + CS1W-CIF31 + XW2Z-200S-V/500S-V + RS-232C port of CPU Unit or Serial Communications Unit				

FA Communications Software

■SYSMAC Gateway (Communications Middleware)

Product	Specifications	Number of licenses	Media	Model
SYSMAC Gateway *1	Communications middleware for personal computers running Windows. Supports CIP communications and tag data links (EtherNet/IP) in addition to FinsGateway functions. (Fins Gateway functions are included.) Supported communications: RS-232C, USB, Controller Link, Ethernet, EtherNet/IP	1	CD-ROM	WS02-SGWC1
	Additional licenses (This product provides only additional licenses for WS02-SGWC1. Purchase of WS02-SGWC1 is required.)	10	---	WS02-SGWC1-L10
SYSMAC Gateway SDK	Software development kit for creating communications programs using SYSMAC Gateway. Development languages: C, C++	1 *2	CD-ROM	WS02-SGWC1S

*1 One license is required per computer (execution environment).

*2 SYSMAC Gateway SDK doesn't include the license of SYSMAC Gateway.

Purchase the WS02-SGWC1 separately if an execution environment is required.



■CX-Compolet

Product	Specifications	Number of licenses	Media	Model	
CX-Compolet *	Software components that can make it easy to create programs for communications between a computer and controllers.	Product includes CX-Compolet and SYSMAC Gateway functions.	1	CD-ROM	WS02-CPLC1
	Supported execution environment: .NET Framework (2.0, 3.0, 3.5, 4.0, 4.5.1, 4.6, 4.7 or 4.8) Development environment: Visual Studio 2010/2012/2013/2015/2017/2019 Development languages: Visual Basic, C# Supported communications: Equal to SYSMAC Gateway.	Additional licenses (This product provides only additional licenses for WS02-CPLC1. Purchase of WS02-CPLC1 is required.)	3	---	WS02-CPLC1-L3
			5	---	WS02-CPLC1-L5
			10	---	WS02-CPLC1-L10
		CX-Compolet (standalone) (SYSMAC Gateway functions are not included.)	1	CD-ROM	WS02-CPLC2

* One license is required per computer (execution environment). Refer to the CJ2 CPU Unit Catalog (Cat. No. V302) for details.



Optional Products and Maintenance Products

Product name	Specifications	Model	Standards
Memory Cards 	Flash memory, 128 MB	HMC-EF183	---
	Flash memory, 256 MB	HMC-EF283	
	Flash memory, 512 MB	HMC-EF583	
	Memory Card Adapter (for computer PCMCIA slot)	HMC-AP001	CE

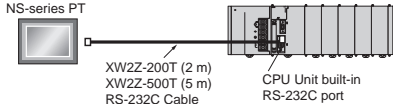
Product name	Specifications	Model	Standards
Battery Set 	Battery for CJ2H-CPU□□(-EIP) and CJ2M-CPU□□ CPU Unit maintenance	CJ1W-BAT01	---
	Note 1. The battery is included as a standard accessory with the CPU Unit. 2. The battery service life is 5 years at 25°C. (The service life depends on the ambient operating temperature and the power conditions.) 3. Use batteries within two years of manufacture.		
End Cover 	Mounted to the right-hand side of CJ-series CPU Racks or Expansion Racks.	CJ1W-TER01	UC1, N, L, CE
RS-422A Converter 	Converts RS-232C to RS-422A/RS-485. (Application example: With a CJ2M-CPU1□ CPU Unit, the Adapter is used for Serial PLC Link at the built-in RS-232C port of the CPU Unit.)	CJ1W-CIF11	UC1, N, L, CE

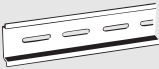

Product name	Specifications		Model	Standards
	Connection configuration	Cable length		
NS-series PT Connecting Cables 	Cable for connecting between an NS-series PT and the RS-232C port on the CPU Unit or Serial Communications Board 	2 m	XW2Z-200T	---
		5 m	XW2Z-500T	

DIN Track Accessories

Product name	Specifications	Model	Standards
DIN Track 	Length: 0.5 m; Height: 7.3 mm	PFP-50N	---
	Length: 1 m; Height: 7.3 mm	PFP-100N	
	Length: 1 m; Height: 16 mm	PFP-100N2	
End Plate 	There are 2 stoppers provided with CPU Units and I/O Interface Units as standard accessories to secure the Units on the DIN Track.	PFP-M	



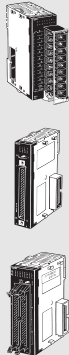

Basic I/O Units

■ Input Units

Unit classification	Product name	Specifications					Current consumption (A)		Model	Standards
		I/O points	Input voltage and current	Commons	External connection	No. of words allocated	5 V	24 V		
CJ1 Basic I/O Units	DC Input Units 	8 inputs	12 to 24 VDC, 10 mA	Independent contacts	Removable terminal block	1 word	0.08	---	CJ1W-ID201	UC1, N, L, CE
		16 inputs	24 VDC, 7 mA	16 points, 1 common	Removable terminal block	1 word	0.08	---	CJ1W-ID211	
		16 inputs <i>High-speed type</i>	24 VDC, 7 mA	16 points, 1 common	Removable terminal block	1 word	0.13	---	CJ1W-ID212	
		32 inputs	24 VDC, 4.1 mA	16 points, 1 common	Fujitsu connector	2 words	0.09	---	CJ1W-ID231 (See note.)	
		32 inputs	24 VDC, 4.1 mA	16 points, 1 common	MIL connector	2 words	0.09	---	CJ1W-ID232 (See note.)	
		32 inputs <i>High-speed type</i>	24 VDC, 4.1 mA	16 points, 1 common	MIL connector	2 words	0.20	---	CJ1W-ID233 (See note.)	
		64 inputs	24 VDC, 4.1 mA	16 points, 1 common	Fujitsu connector	4 words	0.09	---	CJ1W-ID261 (See note.)	
	64 inputs	24 VDC, 4.1 mA	16 points, 1 common	MIL connector	4 words	0.09	---	CJ1W-ID262 (See note.)		
	AC Input Units 	8 inputs	200 to 24 VAC, 10 mA (200 V, 50 Hz)	8 points, 1 common	Removable Terminal Block	1 word	0.08	---	CJ1W-IA201	
		16 inputs	100 to 120 VAC, 7 mA (100 V, 50 Hz)	16 points, 1 common	Removable Terminal Block	1 word	0.09	---	CJ1W-IA111	



Note: Connectors are not provided with these connector models. Either purchase one of the following 40-pin Connectors, or use an OMRON XW2R Connector-Terminal Block Conversion Unit (detail informations: XW2R series Connector-terminal block conversion unit Catalog (Catalog number: G077)) or a G7□ I/O Relay Terminal.

■ Output Units

Unit classification	Product name	Specifications					No. of words allocated	Current consumption (A)		Model	Standards
		Output type	I/O points	Maximum switching capacity	Commons	External connection		5 V	24 V		
CJ1 Basic I/O Units	Relay Contact Output Units 	–	8 outputs	250 VAC/24 VDC, 2 A	Independent contacts	Removable terminal block	1 word	0.09	0.048 max.	CJ1W-OC201	UC1, N, L, CE
		–	16 outputs	250 VAC/24 VDC, 2 A	16 points, 1 common	Removable terminal block	1 word	0.11	0.096 max.	CJ1W-OC211	
	Triac Output Unit 	–	8 outputs	250 VAC, 0.6 A	8 points, 1 common	Removable terminal block	1 word	0.22	–	CJ1W-OA201	
	Transistor Output Units   	Sinking	8 outputs	12 to 24 VDC, 2 A	4 points, 1 common	Removable terminal block	1 word	0.09	–	CJ1W-OD201	
		Sinking	8 outputs	12 to 24 VDC, 0.5 A	8 points, 1 common	Removable terminal block	1 word	0.10	–	CJ1W-OD203	
		Sinking	16 outputs	12 to 24 VDC, 0.5 A	16 points, 1 common	Removable terminal block	1 word	0.10	–	CJ1W-OD211	
		Sinking	16 outputs <i>High-speed type</i>	24 VDC, 0.5 A	16 points, 1 common	Removable terminal block	1 word	0.15	–	CJ1W-OD213	
		Sinking	32 outputs	12 to 24 VDC, 0.5 A	16 points, 1 common	Fujitsu connector	2 words	0.14	–	CJ1W-OD231 (See note.)	
		Sinking	32 outputs	12 to 24 VDC, 0.5 A	16 points, 1 common	MIL connector	2 words	0.14	–	CJ1W-OD233 (See note.)	
		Sinking	32 outputs <i>High-speed type</i>	24 VDC, 0.5 A	16 points, 1 common	MIL connector	2 words	0.22	–	CJ1W-OD234 (See note.)	
		Sinking	64 outputs	12 to 24 VDC, 0.3 A	16 points, 1 common	Fujitsu connector	4 words	0.17	–	CJ1W-OD261 (See note.)	
		Sinking	64 outputs	12 to 24 VDC, 0.3 A	16 points, 1 common	MIL connector	4 words	0.17	–	CJ1W-OD263 (See note.)	
		Sourcing	8 outputs	24 VDC, 2 A Short-circuit protection	4 points, 1 common	Removable terminal block	1 word	0.11	–	CJ1W-OD202	
		Sourcing	8 outputs	24 VDC, 0.5 A Short-circuit protection	8 points, 1 common	Removable terminal block	1 word	0.10	–	CJ1W-OD204	
		Sourcing	16 outputs	24 VDC, 0.5 A Short-circuit protection	16 points, 1 common	Removable terminal block	1 word	0.10	–	CJ1W-OD212	
Sourcing	32 outputs	24 VDC, 0.5 A Short-circuit protection	16 points, 1 common	MIL connector	2 words	0.15	–	CJ1W-OD232 (See note.)			
Sourcing	64 outputs	12 to 24 VDC, 0.3 A	16 points, 1 common	MIL connector	4 words	0.17	–	CJ1W-OD262 (See note.)			

Note: Connectors are not provided with these connector models. Either purchase one of the following 40-pin Connectors, or use an OMRON XW2R Connector-Terminal Block Conversion Unit (detail informations: XW2R series Connector-terminal block conversion unit Catalog (Catalog number: G077)) or a G7□ I/O Relay Terminal.

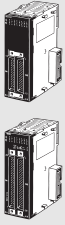
■ I/O Units

Unit classification	Product name	Specifications						Current consumption (A)		Model	Standards
		Output type	I/O points	Input voltage, Input current	Commons	External connection	No. of words allocated	5 V	24 V		
				Maximum switching capacity							
CJ1 Basic I/O Units	DC Input/Transistor Output Units 	Sinking	16 inputs	24 VDC, 7 mA	16 points, 1 common	Fujitsu connector	2 words	0.13	---	CJ1W-MD231 (See note 2.)	UC1, N, CE
			16 outputs	250 VAC/24 VDC, 0.5 A	16 points, 1 common						
		Sinking	16 inputs	24 VDC, 7 mA	16 points, 1 common	MIL connector	2 words	0.13	---	CJ1W-MD233 (See note 2.)	UC1, N, CE
			16 outputs	12 to 24 VDC, 0.5 A	16 points, 1 common						
		Sinking	32 inputs	24 VDC, 4.1 mA	16 points, 1 common	Fujitsu connector	4 words	0.14	---	CJ1W-MD261 (See note 1.)	
			32 outputs	12 to 24 VDC, 0.3 A	16 points, 1 common						
	Sinking	32 inputs	24 VDC, 4.1 mA	16 points, 1 common	MIL connector	4 words	0.14	---	CJ1W-MD263 (See note 1.)		
		32 outputs	12 to 24 VDC, 0.3 A	16 points, 1 common							
	Sourcing	16 inputs	24 VDC, 7 mA	16 points, 1 common	MIL connector	2 words	0.13	---	CJ1W-MD232 (See note 2.)	UC1, N, L, CE	
		16 outputs	24 VDC, 0.5 A Short-circuit protection	16 points, 1 common							
	TTL I/O Units 	---	32 inputs	5 VDC, 35 mA	16 points, 1 common	MIL connector	4 words	0.19	---	CJ1W-MD563 (See note 1.)	UC1, N, CE
			32 outputs	5 VDC, 35 mA	16 points, 1 common						

Note 1. Connectors are not provided with these connector models. Either purchase one of the following 40-pin Connectors, or use an OMRON XW2R Connector-Terminal Block Conversion Unit (detail informations: XW2R series Connector-terminal block conversion unit Catalog (Catalog number: G077)) or a G7□ I/O Relay Terminal.
Note 2. Connectors are not provided with these connector models. Either purchase one of the following 20-pin or 24-pin Connectors, or use an OMRON XW2R Connector-Terminal Block Conversion Unit (detail informations: XW2R series Connector-terminal block conversion unit Catalog (Catalog number: G077)) or a G7□ I/O Relay Terminal.

● Applicable Connectors

Fujitsu Connectors for 32-input, 32-output, 64-input, 64-output, 32-input/32-output, and 16-input/16-output Units

Name	Connection	Remarks	Applicable Units	Model	Standards
40-pin Connectors	Soldered	FCN-361J040-AU Connector FCN-360C040-J2 Connector Cover	Fujitsu Connectors: CJ1W-ID231 (32 inputs): 1 per Unit CJ1W-ID261 (64 inputs): 2 per Unit CJ1W-OD231 (32 outputs): 1 per Unit CJ1W-OD261 (64 outputs): 2 per Unit CJ1W-MD261 (32 inputs, 32 outputs): 2 per Unit	C500-CE404	---
	Crimped	FCN-363J040 Socket FCN-363J-AU Contactor FCN-360C040-J2 Connector Cover		C500-CE405	
	Pressure welded	FCN-367J040-AU/F		C500-CE403	
24-pin Connectors	Soldered	FCN-361J024-AU Connector FCN-360C024-J2 Connector Cover	Fujitsu Connectors: CJ1W-MD231 (16 inputs, 16 outputs): 2 per Unit	C500-CE241	---
	Crimped	FCN-363J024 Socket FCN-363J-AU Contactor FCN-360C024-J2 Connector Cover		C500-CE242	
	Pressure welded	FCN-367J024-AU/F		C500-CE243	

MIL Connectors for 32-input, 32-output, 64-input, 64-output, 32-input/32-output, and 16-input/16-output Units

Name	Connection	Remarks	Applicable Units	Model	Standards
40-pin Connectors	Pressure welded	FRC5-AO40-3TOS	MIL Connectors: CJ1W-ID232/233 (32 inputs): 1 per Unit CJ1W-OD232/233/234 (32 outputs): 1 per Unit CJ1W-ID262 (64 inputs): 2 per Unit CJ1W-OD262/263 (64 outputs): 2 per Unit CJ1W-MD263/563 (32 inputs, 32 outputs): 2 per Unit	XG4M-4030-T	---
20-pin Connectors	Pressure welded	FRC5-AO20-3TOS	MIL Connectors: CJ1W-MD232/233 (16 inputs, 16 outputs): 2 per Unit	XG4M-2030-T	

● Applicable Connector-terminal block conversion unit

Example: With OMRON Connector-terminal block conversion unit

Only main products are shown here.

More detail informations are shown in XW2R series Connector-terminal block conversion unit Catalog (Web Catalog number: G077)

32-point Input Unit or Output Unit

CJ1W-ID231 32-point

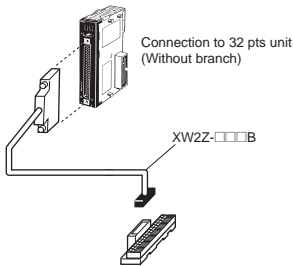

64-point Input Unit or Output Unit

CJ1W-ID261 64-point

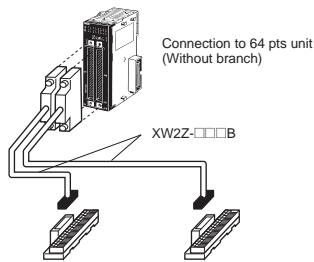

64-point Output Unit

CJ1W-MD563 IN 32 Points, OUT 32 Points

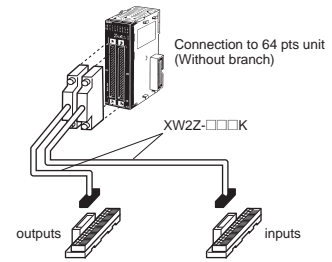

Choose the wiring method.

Choose □□ from a following combination table PLC type.

Wiring method	Model
Models with Phillips screw	XW2R-J34GD-C□
Models with Slotted screw (rise up)	XW2R-E34GD-C□
Models with Push-in spring	XW2R-P34GD-C□



Combination table

PLC Type	I/O	I/O Points	I/O unit model	Connecting cables
C1	Input	32	CJ1W-ID231	XW2Z-□□□B 32-point Unit: 1 Cable 64-point Unit: 2 Cables
	Input/Output	64	CJ1W-ID261	
C2	Input	32	CJ1W-ID232	XW2Z-□□□K 32-point Unit: 1 Cable 64-point Unit: 2 Cables
		64	CJ1W-ID233	
	Input/Output	32	CJ1W-ID262	
		32	CJ1W-MD263 (inputs) CJ1W-MD563 (inputs)	
C3	Output	32	CJ1W-OD231	XW2Z-□□□B 32-point Unit: 1 Cable 64-point Unit: 2 Cables
	Input/Output	64	CJ1W-OD261	
C4	Output	32	CJ1W-MD261 (outputs)	XW2Z-□□□K 32-point Unit: 1 Cable 64-point Unit: 2 Cables
			CJ1W-OD232	
			CJ1W-OD233	
	Output	64	CJ1W-OD234	
			CJ1W-OD262 CJ1W-OD263	
	Input/Output	32	CJ1W-MD263 (outputs)	
			CJ1W-MD563 (outputs)	



Note: 1. □□□ is replaced by the cable length.

2. There is one common for each 32 points.

Connector-terminal block conversion unit

Product name	Wiring method	I/O Points (number of poles)	Model
Connector terminal block conversion unit	Models with Phillips screw 	32 (34)	XW2R-J34GD-C1
		32 (34)	XW2R-J34GD-C2
		32 (34)	XW2R-J34GD-C3
		32 (34)	XW2R-J34GD-C4
	Models with Slotted screw (rise up) 	32 (34)	XW2R-E34GD-C1
		32 (34)	XW2R-E34GD-C2
		32 (34)	XW2R-E34GD-C3
		32 (34)	XW2R-E34GD-C4
	Models with Push-in spring 	32 (34)	XW2R-P34GD-C1
		32 (34)	XW2R-P34GD-C2
		32 (34)	XW2R-P34GD-C3
		32 (34)	XW2R-P34GD-C4

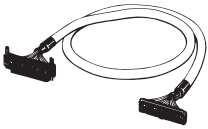
Connecting cables

Product name	Appearance	Connectors	Model	Cable length (m)
For I/O Unit Connecting Cable	XW2Z-□□□B 	One 40-pin MIL Connector to One 40-pin Connector Made by Fujitsu Component, Ltd.	XW2Z-050B	0.5
			XW2Z-100B	1
			XW2Z-150B	1.5
			XW2Z-200B	2
			XW2Z-300B	3
			XW2Z-500B	5
	XW2Z-□□□K 	One 40-pin MIL Connector to One 40-pin MIL Connector	XW2Z-C50K	0.5
			XW2Z-100K	1
			XW2Z-150K	1.5
			XW2Z-200K	2
		XW2Z-300K	3	
		XW2Z-500K	5	

Interrupt Input Units

Unit classification	Product name	Specifications						No. of words allocated	Current consumption (A)		Model	Standards
		I/O points	Input voltage current	Commons	Input pulse width conditions	Max. Units mountable per Unit	External connection		5 V	24 V		
CJ1 Basic I/O Units	Interrupt Input Unit 	16 inputs	24 VDC, 7 mA	16 points, 1 common	ON time: 0.05 ms max. OFF time: 0.5 ms max.	2	Removable terminal block	1 word	0.08	---	CJ1W-INT01	UC1, N, L, CE

Note 1. Can be used only on CPU Racks, and not on Expansion Racks.
Note 2. The locations where the Units can be mounted depend on the CPU Rack and the CPU Unit model.
 CJ2H-CPU6□-EIP: From the slot next to the CPU Unit until the fourth slot.
 CJ2H-CPU6□, CJ2M: From the slot next to the CPU Unit until the fifth slot.

Quick-response Input Units

Unit classification	Product name	Specifications					No. of words allocated	Current consumption (A)		Model	Standards
		I/O points	Input voltage, Input current	Commons	Input pulse width conditions	External connection		5 V	24 V		
CJ1 Basic I/O Units	Quick-response Input Unit 	16 inputs	24 VDC, 7 mA	16 points, 1 common	ON time: 0.05 ms max. OFF time: 0.5 ms max.	Removable terminal block	1 word	0.08	---	CJ1W-IDP01	UC1, N, L, CE

Note: There are no restrictions on the mounting position or number of Units.

B7A Interface Units

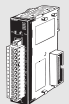
Unit classification	Product name	Specifications		No. of words allocated	Current consumption (A)		Model	Standards
		I/O points	External connection		5 V	24 V		
CJ1 Basic I/O Units	B7A Interface Units 	64 inputs	Removable terminal block	4 words	0.07	---	CJ1W-B7A14	UC1, CE
		64 outputs			0.07	---	CJ1W-B7A04	
		32 inputs/outputs			0.07	---	CJ1W-B7A22	

Special I/O Units and CPU Bus Units

■ Process I/O Units

● Isolated-type Units with Universal Inputs

Unit classification	Product name	Input points	Signal range selection	Signal range	Conversion speed (resolution)	Accuracy (at ambient temperature of 25°C)	External connection	No. of unit numbers allocated	Current consumption (A)		Model	Standards
									5 V	24 V		
CJ1 Special I/O Units	Process Input Units (Isolated-type Units with Universal Inputs) 	4 inputs	Set separately for each input	Universal inputs: Pt100 (3-wire), JPt100 (3-wire), Pt1000 (3-wire), Pt100 (4-wire), K, J, T, E, L, U, N, R, S, B, WRe5-26, PL II, 4 to 20 mA, 0 to 20 mA, 1 to 5 V, 0 to 1.25 V, 0 to 5 V, 0 to 10 V, ±100 mV selectable range -1.25 to 1.25 V, -5 to 5 V, -10 to 10 V, ±10 V selectable range, potentiometer	Resolution (conversion speed): 1/256,000 (conversion cycle: 60 ms/ 4 inputs) 1/64,000 (conversion cycle: 10 ms/ 4 inputs) 1/16,000 (conversion cycle: 5 ms/ 4 inputs)	Standard accuracy: ±0.05% of F.S.	Removable terminal block	1	0.30	---	CJ1W-PH41U (See note 1.)	UC1, CE
		4 inputs	Set separately for each input	Universal inputs: Pt100, JPt100, Pt1000, K, J, T, L, R, S, B, 4 to 20 mA, 0 to 20 mA, 1 to 5 V, 0 to 5 V, 0 to 10 V	Conversion speed: 250 ms/ 4 inputs	Accuracy: Platinum resistance thermometer input: (±0.3% of PV or ±0.8°C, whichever is larger) ±1 digit max. Thermocouple input: (±0.3% of PV or ±1.5°C, whichever is larger) ±1 digit max. (See note 2.) Voltage or current input: ±0.3% of F.S. ±1 digit max.			0.32	---	CJ1W-AD04U	UC1, L, CE

Note 1. Do not connect a Relay Output Unit to the same CPU Rack or to the same Expansion Rack as the CJ1W-PH41U.
2. L and -100°C or less for K and T are ±2°C±1 digit max., and 200°C or less for R and S is ±3°C±1 digit max. No accuracy is specified for 400°C or less for B.

● Isolated-type Thermocouple Input Units

Unit classification	Product name	Input points	Signal range selection	Signal range	Conversion speed (resolution)	Accuracy (at ambient temperature of 25°C)	External connection	No. of unit numbers allocated	Current consumption (A)		Model	Standards
									5 V	24 V		
CJ1 Special I/O Units	Process Input Units (Isolated-type Thermocouple Input Units) 	2 inputs	Set separately for each input	Thermocouple: B, E, J, K, L, N, R, S, T, U, WRe5-26, PLII DC voltage: ±100 mV	Conversion speed: 10 ms/ 2 inputs, Resolution: 1/64,000	Standard accuracy: ±0.05% of F.S. (See note 1.)	Removable terminal block	1	0.18	(See note 2.)	CJ1W-PTS15	UC1, CE
		4 inputs		Thermocouple: R, S, K, J, T, L, B	Conversion speed: 250 ms/ 4 inputs	Accuracy: (±0.3% of PV or ±1°C, whichever is larger) ±1 digit max. (See note 3.)					0.25	

Note 1. The accuracy depends on the sensors used and the measurement temperatures. For details, refer to the user's manual.
2. This is for an external power supply, and not for internal current consumption.
3. L and -100°C or less for K and T are ±2°C±1 digit max., and 200°C or less for R and S is ±3°C±1 digit max. No accuracy is specified for 400°C or less for B.

● Isolated-type Resistance Thermometer Input Units

Unit classification	Product name	Input points	Signal range selection	Signal range	Conversion speed (resolution)	Accuracy (at ambient temperature of 25°C)	External connection	No. of unit numbers allocated	Current consumption (A)		Model	Standards
									5 V	24 V		
CJ1 Special I/O Units	Process Analog Input Units (Isolated-type Resistance Thermometer Input Units) 	4 inputs	Common inputs	Resistance thermometer: Pt100, JPt100	Conversion speed: 250 ms/4 inputs	Accuracy: ±0.3°C of PV or ±0.8°C, whichever is larger, ±1 digit max.	Removable terminal block	1	0.25	---	CJ1W-PTS52	UC1, CE

Note: This is for an external power supply, and not for internal current consumption.



● Isolated-type DC Input Units

Unit classification	Product name	Input points	Signal range selection	Conversion speed (resolution)	Accuracy (at ambient temperature of 25°C)	External connection	No. of unit numbers allocated	Current consumption (A)		Model	Standards
								5 V	24 V		
CJ1 Special I/O Units	Isolated-type DC Input Units 	2 inputs	DC voltage: 0 to 1.25 V, -1.25 to 1.25 V, 0 to 5 V, 1 to 5 V, -5 to 5 V, 0 to 10 V, -10 to 10 V, ±10 V selectable range DC current: 0 to 20 mA, 4 to 20 mA	Conversion speed: 10 ms/2 inputs Resolution: 1/64,000	Standard accuracy: ±0.05% of F.S.	Removable terminal block	1	0.18	0.09 (See note.)	CJ1W-PDC15	UC1, CE

Note: This is for an external power supply, and not for internal current consumption.

■ Analog I/O Units

● Analog Input Units

Unit classification	Product name	Input points	Signal range selection	Signal range	Resolution	Conversion speed	Accuracy (at ambient temperature of 25°C)	External connection	No. of unit numbers allocated	Current consumption (A)		Model	Standards
										5 V	24 V		
CJ1 Special I/O Units	Analog Input Units <small>High-speed type</small> 	4 inputs	Set separately for each input	1 to 5 V (1/10,000), 0 to 10 V (1/20,000), -5 to 5 V (1/20,000), -10 to 10 V (1/40,000), and 4 to 20 mA (1/10,000)		20 μs/1 point, 25 μs/2 points, 30 μs/3 points, 35 μs/4 points The Direct conversion is provided.	Voltage: ±0.2% of F.S. Current: ±0.4% of F.S.	Removable terminal block	1	0.52	---	CJ1W-AD042	UC1, CE
		Analog Input Units 	8 inputs		1 to 5 V, 0 to 5 V, 0 to 10 V, -10 to 10 V, 4 to 20 mA	1/4000, (Settable to 1/8000) (See note 1.)	1 ms/point max. (Settable to 250 μs/point) (See note 1.)	Voltage: ±0.2% of F.S. Current: ±0.4% of F.S. (See note 2.)		0.42	---	CJ1W-AD081-V1	UC1, N, L, CE
		4 inputs							0.42	---	CJ1W-AD041-V1		

Note 1. The resolution and conversion speed cannot be set independently. If the resolution is set to 1/4,000, then the conversion speed will be 1 ms/point.
2. At 23 ±2°C

● Analog Output Units

Unit classification	Product name	Output points	Signal range selection	Signal range	Resolution	Conversion speed	Accuracy (at ambient temperature of 25°C)	External connection	External power supply	No. of unit numbers allocated	Current consumption (A)		Model	Standards
											5 V	24 V		
CJ1 Special I/O Units	Analog Output Units 	4 outputs	Set separately for each input	1 to 5 V (1/10,000), 0 to 10 V (1/20,000), and -10 to 10 V (1/40,000)	20 μs/ 1 point, 25 μs/ 2 points, 30 μs/ 3 points, 35 μs/ 4 points The Direct conversion is provided.	±0.3% of F.S.	Removable terminal block	---	1	0.40	---	CJ1W-DA042V	UC1, CE	
	8 outputs	1 to 5 V, 0 to 5 V, 0 to 10 V, -10 to 10 V										1 ms/ point max. (Settable to 250 μs/point)		24 VDC +10% -15% , 140 mA max.
	8 outputs	4 to 20 mA		1/4,000 (Settable to 1/8,000)	24 VDC +10% -15% , 170 mA max.	0.14 (See note.)		CJ1W-DA08C	UC1, N, CE					
	4 outputs	1 to 5 V, 0 to 5 V, 0 to 10 V, -10 to 10 V, 4 to 20 mA		1/4000	1 ms/ point max.	Voltage output: ±0.3% of F.S. Current output: ±0.5% of F.S.		24 VDC +10% -15% , 200 mA max.	0.12 (See note.)	CJ1W-DA041	UC1, N, L, CE			
	2 outputs							24 VDC +10% -15% , 140 mA max.	0.12 (See note.)	CJ1W-DA021				

Note: This is for an external power supply, and not for internal current consumption

● Analog I/O Units

Unit classification	Product name	No. of points	Signal range selection	Signal range	Resolution (See note.)	Conversion speed (See note.)	Accuracy (at ambient temperature of 25°C)	External connection	No. of unit numbers allocated	Current consumption (A)		Model	Standards
										5 V	24 V		
CJ1 Special I/O Units	Analog I/O Units 	4 inputs 2 outputs	Set separately for each input	1 to 5 V, 0 to 5 V, 0 to 10 V, -10 to 10 V, 4 to 20 mA	1/4,000 (Settable to 1/8,000)	1 ms/point (Settable to 500 μs/point max.)	Voltage input: ±0.2% of F.S. Current input: ±0.2% of F.S. Voltage output: ±0.3% of F.S. Current output: ±0.3% of F.S.	Removable terminal block	1	0.58	---	CJ1W-MAD42	UC1, N, L, CE

Note: The resolution and conversion speed cannot be set independently. If the resolution is set to 1/4,000, then the conversion speed will be 1 ms/point.

■ Temperature Control Units

Unit classification	Product name	Specifications			No. of unit numbers allocated	Current consumption (A)		Model	Standards
		No. of loops	Temperature sensor inputs	Control outputs		5 V	24 V		
CJ1 Special I/O Units	Temperature Control Units 	4 loops	Thermocouple input (R, S, K, J, T, B, L)	Open collector NPN outputs (pulses)	2	0.25	---	CJ1W-TC001	UC1, N, L, CE
		4 loops		Open collector PNP outputs (pulses)		0.25	---	CJ1W-TC002	
		2 loops, heater burnout detection function		Open collector NPN outputs (pulses)		0.25	---	CJ1W-TC003	
		2 loops, heater burnout detection function		Open collector PNP outputs (pulses)		0.25	---	CJ1W-TC004	
		4 loops	Platinum resistance thermometer input (JPt100, Pt100)	Open collector NPN outputs (pulses)		0.25	---	CJ1W-TC101	
		4 loops		Open collector PNP outputs (pulses)		0.25	---	CJ1W-TC102	
		2 loops, heater burnout detection function		Open collector NPN outputs (pulses)		0.25	---	CJ1W-TC103	
		2 loops, heater burnout detection function		Open collector PNP outputs (pulses)		0.25	---	CJ1W-TC104	

■ High-speed Counter Unit

Unit classification	Product name	Specifications			No. of unit numbers allocated	Current consumption (A)		Model	Standards
		Countable channels	Encoder A and B inputs, pulse input Z signals	Max. counting rate		5 V	24 V		
CJ1 Special I/O Units	High-speed Counter Unit 	2	Open collector Input voltage: 5 VDC, 12 V, or 24 V (5 V and 12 V are each for one axis only.)	50 kHz	4	0.28	---	CJ1W-CT021 *	UC1, N, L, CE
			RS-422 line driver	500 kHz					

* Use Lot No.030121 or later (Unit Version 1.06) of CJ1W-CT021 when using with CJ2 CPU Units.

■ Position Control Units

● Position Control Units (High-speed type)

Unit classification	Product name	Specifications		No. of unit numbers allocated	Current consumption (A)		Model	Standards		
					5 V	24 V				
		Control output interface		No. of axes						
CJ1 Special I/O Units	Position Control Units <small>High-speed type</small>	Pulse-train open-collector output with Pulse Counter Function		2 axes	2	0.27	---	CJ1W-NC214	UL1, CE	
				4 axes		0.31	---	CJ1W-NC414		
		Pulse-train line-driver output with Pulse Counter Function		2 axes	2	0.27	---	CJ1W-NC234		
				4 axes		0.31	---	CJ1W-NC434		
	Position Control Unit Cables	Open-collector output	For CJ1W-NC214/NC414	Connecting Servo Drives: G Series R88D-GT G5 Series R88D-KT		1 axis	Cable length: 1 m		XW2Z-100J-G13	---
							Cable length: 3 m		XW2Z-300J-G13	
				Connecting Servo Drives: SMARTSTEP2 R7D-BP		1 axis	Cable length: 1 m		XW2Z-100J-G14	
							Cable length: 3 m		XW2Z-300J-G14	
				Connecting Servo Drives: G Series R88D-GT G5 Series R88D-KT		2 axes	Cable length: 1 m		XW2Z-100J-G5	
							Cable length: 3 m		XW2Z-300J-G5	
				Connecting Servo Drives: SMARTSTEP2 R7D-BP		2 axes	Cable length: 1 m		XW2Z-100J-G6	
							Cable length: 3 m		XW2Z-300J-G6	
		Line-driver output	For CJ1W-NC234/NC434	Connecting Servo Drives: G Series R88D-GT G5 Series R88D-KT		1 axis	Cable length: 1 m		XW2Z-100J-G9	
							Cable length: 5 m		XW2Z-500J-G9	
				Connecting Servo Drives: SMARTSTEP2 R7D-BP		1 axis	Cable length: 10 m		XW2Z-10MJ-G9	
							Cable length: 1 m		XW2Z-100J-G12	
				Applicable Servo Drive: G Series R88D-GT G5 Series R88D-KT		2 axes	Cable length: 5 m		XW2Z-500J-G12	
							Cable length: 10 m		XW2Z-10MJ-G12	
				Applicable Servo Drive: SMARTSTEP2 R7D-BP		2 axes	Cable length: 1 m		XW2Z-100J-G1	
							Cable length: 5 m		XW2Z-500J-G1	
		2 axes	Cable length: 10 m		XW2Z-10MJ-G1					
			Cable length: 1 m		XW2Z-100J-G4					
		2 axes	Cable length: 5 m		XW2Z-500J-G4					
		2 axes	Cable length: 10 m		XW2Z-10MJ-G4					

● Position Control Units

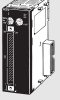
Unit classification	Product name	Specifications			No. of unit numbers allocated	Current consumption (A)		Model	Standards	
		Control output interface		No. of axes		5 V	24 V			
CJ1 Special I/O Units	Position Control Units 	Pulse train, open collector output		1 axis	1	0.25	---	CJ1W-NC113	UC1, CE	
		Pulse train, open collector output		2 axes		0.25	---	CJ1W-NC213		
		Pulse train, open collector output (See note.)		4 axes	2	0.36	---	CJ1W-NC413		
		Pulse train, line driver output		1 axis		0.25	---	CJ1W-NC133		
		Pulse train, line driver output		2 axes	1	0.25	---	CJ1W-NC233		
		Pulse train, line driver output (See note.)		4 axes		0.36	---	CJ1W-NC433		
	Space Unit	Use a CJ1W-SP001 Space Unit if the operating temperature is 0 to 55°C.						CJ1W-SP001	UC1, CE	
	Servo Relay Units	For 1-Axis Position Control Unit (without communications support) (CJ1W-CN113/133)						XW2B-20J6-1B	---	
		For 2- or 4-Axes Position Control Unit (without communications support) (CJ1W-NC213/233/413/433)						XW2B-40J6-2B		
		For 2- or 4-Axes Position Control Unit (with communications support) (CJ1W-NC213/233/413/433)						XW2B-40J6-4A		
	Position Control Unit Cables	Open-collector output	For CJ1W-NC113	Connecting Servo Drives: G5/G Series, SMARTSTEP2		1 axis	Cable length: 0.5 m		XW2Z-050J-A14	---
				Cable length: 1 m			XW2Z-100J-A14			
			For CJ1W-NC213/413	Connecting Servo Drives: G5/G Series, SMARTSTEP2		2 axes	Cable length: 0.5 m		XW2Z-050J-A15	
				Cable length: 1 m			XW2Z-100J-A15			
Line-driver output		For CJ1W-NC133	Connecting Servo Drives: G5/G Series, SMARTSTEP2		1 axis	Cable length: 0.5 m		XW2Z-050J-A18		
			Cable length: 1 m			XW2Z-100J-A18				
		For CJ1W-NC233/433	Connecting Servo Drives: G5/G Series, SMARTSTEP2		2 axes	Cable length: 0.5 m		XW2Z-050J-A19		
			Cable length: 1 m			XW2Z-100J-A19				

Note: The ambient operating temperature for 4-Axes Position Control Units is 0 to 50°C; the allowable voltage fluctuation on the external 24-VDC power supply is 22.8 to 25.2 VDC (24 V ±5%).

■ Position Control Unit with EtherCAT interface

Unit classification	Product name	Specifications		No. of unit numbers allocated	Current consumption (A)		Model	Standards
		Control output interface	No. of axes		5 V	24 V		
CJ1 CPU Bus Units	Position Control Unit with EtherCAT interface 	Control commands executed by EtherCAT communications. Positioning functions: Memory operation, Direct operation by ladder programming	2 axes	1	0.46	---	CJ1W-NC281	UC1, CE
			4 axes				CJ1W-NC481	
			8 axes				CJ1W-NC881	
			16 axes				CJ1W-NCF81	
		Control commands executed by EtherCAT communications. • Positioning functions: Memory operation, Direct operation by ladder programming • I/O communication : 64 nodes	4 axes	1	0.46	---	CJ1W-NC482	
			8 axes				CJ1W-NC882	
16 axes	CJ1W-NCF82							

Note: Use Category 5 or higher cables with double shield of aluminium tape and braid shield for connection with EtherCAT Slaves. We also recommend you to use Category 5 or higher modular connectors.

■ EtherCAT Slave Unit



Unit type	Product name	Specifications		No. of unit numbers allocated	Current consumption (A)		Model	Standards
		Communications cable	Communications functions		5 V	24 V		
CJ1 CPU Bus Unit	EtherCAT Slave Unit 	STP (shielded twisted-pair) cable of category 5 or higher with double shielding	Refreshing methods: Free-Run Mode PDO data sizes: TxPDO 400byte max./ RxPDO: 400byte max.	1	0.34	---	CJ1W-ECT21	UC1,CE,KC

● Recommended EtherCAT Communications Cables

Category 5 or higher (100BASE-TX) straight cable with double shielding (aluminum tape and braided shielding) is recommended.

Cabel with Connectors

Wire Gauge and Number of Pairs: AWG22, 2-pair Cable

Item	Appearance	Recommended manufacturer	Cable length(m)	Model
Cable with Connectors on Both Ends (RJ45/RJ45)		OMRON	0.3	XS5W-T421-AMD-K
			0.5	XS5W-T421-BMD-K
			1	XS5W-T421-CMD-K
			2	XS5W-T421-DMD-K
			5	XS5W-T421-GMD-K
			10	XS5W-T421-JMD-K
Cable with Connectors on Both Ends (M12/RJ45)		OMRON	0.3	XS5W-T421-AMC-K
			0.5	XS5W-T421-BMC-K
			1	XS5W-T421-CMC-K
			2	XS5W-T421-DMC-K
			5	XS5W-T421-GMC-K
			10	XS5W-T421-JMC-K

Note: The cable length 0.3, 0.5, 1, 2, 3, 5, 10 and 15m are available. For details, refer to Cat.No.G019.

Cables / Connectors

Wire Gauge and Number of Pairs: AWG24, 4-pair Cable

Item	Appearance	Recommended manufacturer	Model
Cables	---	Tonichi Kyosan Cable, Ltd.	NETSTAR-C5E SAB 0.5 × 4P CP
	---	Kuramo Electric Co.	KETH-SB
	---	SWCC Showa Cable Systems Co.	FAE-5004
RJ45 Connectors	---	Panduit Corporation	MPS588

Wire Gauge and Number of Pairs: AWG22, 2-pair Cable



Item	Appearance	Recommended manufacturer	Model
Cables	---	Kuramo Electric Co.	KETH-PSB-OMR *
RJ45 Assembly Connector		OMRON	XS6G-T421-1 *

* We recommend you to use above cable and connector together.

■Position Control Unit with MECHATROLINK-II interface

Unit classification	Product name	Specifications		No. of unit numbers allocated	Current consumption (A)		Model	Standards
		Control output interface	No. of axes		5 V	24 V		
CJ1 CPU Bus Units	Position Control Unit with MECHATROLINK-II interface 	Control commands executed by MECHATROLINK-II synchronous communications. Direct operation by ladder programming. Control mode: Position control, speed control, or torque control	2 axes	1	0.36	---	CJ1W-NC271	UC1, CE
			4 axes				CJ1W-NC471	
			16 axes				CJ1W-NCF71	
			16 axes				CJ1W-NCF71-MA	
	MECHATROLINK-II Cables	MECHATROLINK-II Cables (without ring core and USB connector on both ends) Note: Can be connected to R88D-GN and R88D-KN only.	MECHATROLINK-II Cables (with ring core and USB connector on both ends) (Yaskawa Electric Corporation) Use the model numbers provided in this catalog when ordering from OMRON.	Cable length: 0.5 m		FNY-W6002-A5	---	
				Cable length: 1 m		FNY-W6002-01		
				Cable length: 3 m		FNY-W6002-03		
				Cable length: 5 m		FNY-W6002-05		
				Cable length: 0.5 m		FNY-W6003-A5	---	
				Cable length: 1 m		FNY-W6003-01		
				Cable length: 3 m		FNY-W6003-03		
				Cable length: 5 m		FNY-W6003-05		
				Cable length: 10 m		FNY-W6003-10		
				Cable length: 20 m		FNY-W6003-20		
Cable length: 30 m		FNY-W6003-30						
MECHATROLINK-II Terminating Resistors	Terminating Resistor for MECHATROLINK-II (Yaskawa Electric Corporation) Use the model numbers provided in this catalog when ordering from OMRON.				FNY-W6022	---		
MECHATROLINK-II Repeater	Repeater (Yaskawa Electric Corporation)				JEPMC-REP2000-E	---		

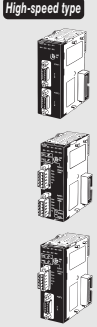
■ Serial Communications Units

Unit classification	Product name	Specifications		No. of unit numbers allocated	Current consumption (A)		Model	Standards		
		Communications Interface	Communications functions		5 V	24 V				
CJ1 CPU Bus Units	Serial Communications Units 	2 RS-232C ports	The following functions can be selected for each port: Protocol macro Host Link NT Links (1:N mode) Serial Gateway No-protocol Modbus-RTU Slave	1	0.29 (See note 1.)	---	CJ1W-SCU22	UC1, N, L, CE		
		2 RS-422A/485 ports			0.46	---	CJ1W-SCU32			
		1 RS-232C port and 1 RS-422A/485 port			0.38 (See note 1.)	---	CJ1W-SCU42			
	Serial Communications Units 	2 RS-232C ports			The following functions can be selected for each port: Protocol macro Host Link NT Links (1:N mode) Serial Gateway (See note 2.) No-protocol (See note 3.) Modbus-RTU Slave (See note 4.)	1	0.28 (See note 1.)		---	CJ1W-SCU21-V1
		2 RS-422A/485 ports					0.38		---	CJ1W-SCU31-V1
		1 RS-232C port and 1 RS-422A/485 port					0.38 (See note 1.)		---	CJ1W-SCU41-V1

- Note 1.** When an NT-AL001 RS-232C/RS-422A Conversion Unit is used, this value increases by 0.15 A/Unit. Add 0.20A/Unit when using NV3W-M□20L(-V1) Programmable Terminals. Add 0.04A/Unit when using CJ1W-CIF11 RS-422A Adapters.
- 2.** The Serial Gateway function is enabled only for Serial Communications Units of unit version 1.2 and later.
- 3.** The no-protocol function is enabled only for Serial Communications Units of unit version 1.2 and later (and a CPU Unit of unit version 3.0 or later is also required).
- 4.** The Modbus-RTU Slave function is enabled only for Serial Communications Units of unit version 1.3 and later.

■ EtherNet/IP Unit

Unit classification	Product name	Specifications			No. of unit numbers allocated	Current consumption (A)		Model	Standards
		Communications cable	Communications functions	Max.Units mountable per CPU Unit		5 V	24 V		
CJ1 CPU Bus Unit	EtherNet/IP Unit 	STP (shielded twisted-pair) cable of category 5, 5e, or higher.	Tag data link message service	8 (See note)	1	0.41	---	CJ1W-EIP21	UC1, N, L, CE

Note: Up to seven EtherNet/IP Units can be connected to a CJ2H-CPU□□-EIP. Up to two EtherNet/IP Units can be connected to a CJ2M CPU Unit.

■ Ethernet Unit

Unit classification	Product name	Specifications			No. of unit numbers allocated	Current consumption (A)		Model	Standards
		Communications cable	Communications functions	Max.Units mountable per CPU Unit		5 V	24 V		
CJ1 CPU Bus Unit	Ethernet Unit 	100Base-TX	FINS communications service (TCP/IP, UDP/IP), FTP server functions, socket services, mail transmission service, mail reception (remote command receive), automatic adjustment of PLC's built-in clock, server/host name specifications	4	1	0.37	---	CJ1W-ETN21	UC1, N, L, CE

● Industrial Switching Hubs

Product name	Appearance	Functions	No. of ports	Accessories	Current consumption (A)	Model
Industrial Switching Hubs		Quality of Service (QoS): EtherNet/IP control data priority 10/100BASE-TX, Auto-Negotiation	5	Power supply connector	0.07	W4S1-05D

● WE70 FA WIRELESS LAN UNITS

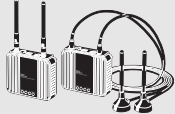
Product name	Applicable region	Type	Model	Standards
 WE70 FA WIRELESS LAN UNITS	Japan	Access Point (Master)	WE70-AP	---
		Client (Slave)	WE70-CL	
	Europe	Access Point (Master)	WE70-AP-EU	CE
		Client (Slave)	WE70-CL-EU	
	Canada	Access Point (Master)	WE70-AP-CA *	UC
		Client (Slave)	WE70-CL-CA *	
China	Access Point (Master)	WE70-AP-CN	---	
	Client (Slave)	WE70-CL-CN		

- Note 1.** A Pencil Antenna, mounting magnet, and screw mounting bracket are included as accessories.
2. Always use a model that is applicable in your region. Refer to the *WE70 Catalog* (Cat. No. N154).
3. Final order entry date: The end of June, 2020.

* From January 2016, the WE70-AP-CA and WE70-CL-CA can be used in Singapore.

■ Controller Link Units

● Controller Link Units

Unit classification	Product name	Specifications				No. of unit numbers allocated	Current consumption (A)		Model	Standards
		Communications cable	Communications type	Duplex support	Max. Units mountable per CPU Unit		5 V	24 V		
CJ1 CPU Bus Unit	 Controller Link Unit	Wired shielded twisted-pair cable (See note.)	Data links and message service	No	8	1	0.35	---	CJ1W-CLK23	UC1, N, L, CE

- Note:** Use the following special cable for shielded, twisted-pair cable.
- ESVC0.5 × 2C-13262 (Bando Electric Wire: Japanese Company)
 - ESNCO.5 × 2C-99-087B (JMACS Japan Co., Ltd.: Japanese Company)
 - ESPC 1P × 0.5 mm² (Nagaoka Electric Wire Co., Ltd.: Japanese Company)
 - Li2Y-FCY2 × 0.56qmm (Kromberg & Schubert, Komtec Department: German Company)
 - 1 × 2 × AWG-20PE+Tr.CUSN+PVC (Draka Cables Industrial: Spanish Company)
 - #9207 (Belden: US Company)

● Controller Link Support Boards

Unit classification	Specification		Accessories	Model	Standards
	Communications cable	Communications type			
 Controller Link Support Board for PCI Bus	Wired shielded twisted-pair cable	Data link and message service	<ul style="list-style-type: none"> • CD-ROM × 1 (See note.) • INSTALLATION GUIDE (W467) × 1 • Communications connector × 1 	3G8F7-CLK23-E	CE, KC

- Note:** The CD-ROM contains FinsGateway Version 2003 (PCI-CLK Edition) and FinsGateway Version 3 (PCI-CLK Edition).
 Install the software from CD Ver 3.10 or higher if the operating system is Windows 7 (32bit) or Windows Vista.
 Install FinsGateway version 3 if the operating system is Windows NT 4.0 (Service pack 3 or higher), Windows ME, or Windows 98SE.

● Repeater Units

Unit classification	Specifications	Model	Standards
Controller Link Repeater Unit 	Wire-to-wire Model	CS1W-RPT01	UC1, CE
	Wire-to-Optical (H-PCF) Model (See note 2.)	CS1W-RPT02	
	Wire-to-Optical (GI) Model (See note 3.)	CS1W-RPT03	

Note 1. Using Repeater Units enables T-branches and long-distance wiring for Wired Controller Link networks. 62-node configurations, and converting part of the network to optical cable.



2. When using wire-to-optical (H-PCF) cable, use a H-PCF cable (for both Controller Link and SYSMAC LINK) or a H-PCF optical fiber cable with connector.
3. When using wire-to-optical (GI) cable, use a GI optical cable (for Controller Link).

● Relay Terminal Block

Unit classification	Specifications	Model	Standards
Relay Terminal Block for Wired Controller Link Unit 	Use for Wired Controller Link Units (set of 5).	CJ1W-TB101	---

Note: Controller Link Units can be replaced without stopping the communications of the entire network if a Relay Terminal Block is installed in advance on the Unit in a Wired Controller Link network. Relay Blocks cannot be used on Controller Link Support Boards.

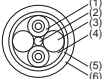
● H-PCF Cables and Optical Connectors

Name	Application/construction		Specifications	Model	Standards	
Optical Fiber Cables	Controller Link, SYSMAC LINK, SYSBUS	 <ol style="list-style-type: none"> (1) Optical fiber single-core cord (2) Tension member (plastic-sheathed wire) (3) Filler (plastic) (4) Filler surrounding signal wires (plastic, yarn, or fiber) (5) Holding tape (plastic) (6) Heat-resistant PV sheath 	Two-core optical cable with tension member	Black 10 m	S3200-HCCB101	---
				Black 50 m	S3200-HCCB501	
				Black 100 m	S3200-HCCB102	
				Black 500 m	S3200-HCCB502	
				Black 1,000 m	S3200-HCCB103	
				Orange 10 m	S3200-HCCO101	
				Orange 50 m	S3200-HCCO501	
				Orange 100 m	S3200-HCCO102	
				Orange 500 m	S3200-HCCO502	
				Orange 1,000 m	S3200-HCCO103	
Optical Connectors (Crimp-cut) 	CS1W-RPT02		Half lock	S3200-COCF2571		
			Full lock	S3200-COCF2071		

● **H-PCF Optical Fiber Cables with Connectors (Black Composite Cables with Two-Optical Lines and Two Power Supply Lines)**

Application	Appearance	Model	Standards
Controller Link, SYSMAC Link		S3200-CN□□□□-20-20	---
		S3200-CN□□□□-20-25	
		S3200-CN□□□□-25-25	

● **Cable Length**

The following cable lengths are available: 2 m, 5 m, 15 m, 20 m. For lengths of 21 m or more, contact your OMRON sales representative.

● **Model Numbers**

Lengths of 2 m, 5 m, 10 m, 15 m, and 20 m

Example: S3200-CN□□□□-20-25

Length of 21 m or more

Example: S3200-CN-20-20

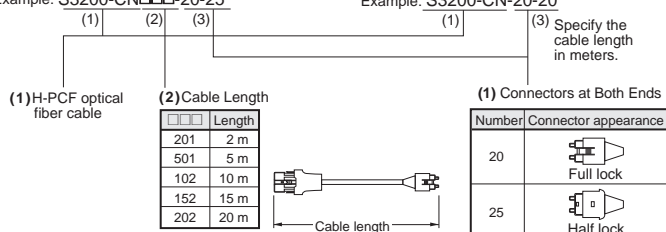

● **Optical Connector Assembly Tool**

Name	Applicable Unit	Model	Manufacturer	Standards
Optical Fiber Assembly Tool (See note.)	This tool is used on site for mounting crimp-cut connectors and hard plastic-clad silica optical fiber for optical transmission systems of C-series SYSBUS, SYSMAC LINK, and Controller Link.	CAK-0057	Sumitomo Electric Industries, Ltd.	---

Note: There is a risk of quality problems when using cables assembled by typical users, so we recommend purchasing cables with preattached connectors or having a qualified technician assemble the cables. Optical connectors for H-PCF Optical Cables with Connectors are adhesive polished.

● **GI Optical Cables**

A qualified technician must select, assemble, and install GI Optical Fiber Cable, so always let an optical cable specialist handle the GI cable.

Usable Optical Cables and Optical Connectors

- Optical fiber types: Graded, indexed, multi-mode, all quartz glass, fiber (GI-type AGF cable)
- Optical fiber construction (core diameter/clad diameter): 62.5/125 μm or 50/125 μm
- Optical fiber optical characteristics of optical fiber: Refer to the tables.
- Optical connector: ST connector (IEC-874-10)

● **50/125 μm AGF Cable**

Item	Minimum	Standard	Maximum	Remarks
Numerical Aperture (N.A)	---	0.21	---	---
Transmission loss (dB)	---	---	3.0 Lf	0.5 km ≤ Lf
			3.0 Lf + 0.2	0.2 km ≤ Lf ≤ 0.5 km
			3.0 Lf + 0.4	Lf ≤ 0.2 km
Connection loss (dB)	---	---	1.0	λ = 0.8 μm, one location
Transmission bandwidth (MHz-km)	500	---	---	λ = 0.85 μm (LD)

Lf is fiber length in km, Ta is ambient temperature, and λ: is the peak wavelength of the test light source.

● **62.5/125 μm AGF Cable**

Item	Minimum	Standard	Maximum	Remarks
Numerical Aperture (N.A)	---	0.28	---	---
Transmission loss (dB)	---	---	3.5 Lf	0.5 km ≤ Lf
			3.5 Lf + 0.2	0.2 km ≤ Lf ≤ 0.5 km
			3.5 Lf + 0.4	Lf ≤ 0.2 km
Connection loss (dB)	---	---	1.0	λ = 0.8 μm, one location
Transmission bandwidth (MHz-km)	200	---	---	λ = 0.85 μm (LD)

Lf is fiber length in km, Ta is ambient temperature, and λ is the peak wavelength of the test light source.

■ FL-net Unit

Unit classification	Product name	Specifications			No. of unit numbers allocated	Current consumption (A)		Model	Standards
		Communications interface	Communications functions	Max. Units mountable per CPU Units		5 V	24 V		
CJ1 CPU Bus Units	 FL-net Unit	100Base-TX	With FL-net Ver. 2.0 specifications (OPCN-2) Data links and message service	4	1	0.37	---	CJ1W-FLN22	UC1, CE

■ DeviceNet Unit

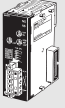
Unit classification	Product name	Specifications	Communications type	No. of unit numbers allocated	Current consumption (A)		Model	Standards
					5 V	24 V		
CJ1 CPU Bus Units	 DeviceNet Unit	Functions as master and/or slave; allows control of 32,000 points max. per master.	<ul style="list-style-type: none"> Remote I/O communications master (fixed or user-set allocations) Remote I/O communications slave (fixed or user-set allocations) Message communications 	1	0.29	---	CJ1W-DRM21	UC1, N, L, CE

■ CompoNet Master Unit

Unit classification	Product name	Specifications		No. of unit numbers allocated	Current consumption (A)		Model	Standards
		Communications functions	No. of I/O points per Master Unit		5 V	24 V		
CJ1 Special I/O Units	 CompoNet Master Unit	<ul style="list-style-type: none"> Remote I/O communications Message communications 	Word Slaves: 2,048 max. (1,024 inputs and 1,024 outputs) Bit Slaves: 512 max. (256 inputs and 256 outputs)	1, 2, 4, or 8	0.4	---	CJ1W-CRM21	U, U1, N, L, CE

■ CompoBus/S Master Unit

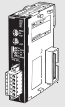
Unit classification	Product name	Specifications			No. of unit numbers allocated	Current consumption (A)		Model	Standards
		Communications functions	No. of I/O points	Max. Units mountable per CPU Unit		5 V	24 V		
CJ1 Special I/O Units	 CompoBus/S Master Unit	Remote I/O communications	256 max. (128 inputs and 128 outputs) 128 max. (64 inputs and 64 outputs)	40	1 or 2 (variable)	0.15	---	CJ1W-SRM21	UC1, N, L, CE

■ ID Sensor Units

Unit classification	Product name	Specifications			No. of unit numbers allocated	Current consumption (A)		Model	Standards
		Connected ID Systems	No. of connected R/W heads	External power supply		5 V	24 V		
CJ1 CPU Bus Units	 ID Sensor Units	V680 Series RFID System	1	Not required.	1	0.26	0.13 (See note.)	CJ1W-V680C11	UC, CE
			2		2	0.32	0.26	CJ1W-V680C12	
		V600 Series RFID System	1	Not required.	1	0.26	0.12	CJ1W-V600C11	
			2		2	0.32	0.24	CJ1W-V600C12	

Note: To use a V680-H01 Antenna, refer to the V680 Series RFID System Catalog (Cat. No. Q151).

■SPU Unit (High-speed Data Storage Unit)

Unit classification	Product name	Specifications		No. of unit numbers allocated	Current consumption (A)		Model	Standards
		PC Card slot	Ethernet (LAN) port		5 V	24 V		
CJ1 CPU Bus Units	SPU Unit (High-speed Data Storage Unit) 	CF Card Type I/II × 1 slot Use an OMRON HMC-EF□□□ Memory Card.	1 port (10/100Base-TX)	1	0.56	---	CJ1W-SPU01-V2	UC1, CE
	SPU-Console	Functions: Unit settings, sampling settings, etc., for High-speed Data Collection Units (required for making settings for this Unit) OS: Microsoft Windows 10 (32 bit/64 bit) Microsoft Windows 8.1 (32 bit/64 bit) Microsoft Windows 8 (32 bit/64 bit) Microsoft Windows 7 (32 bit/64 bit)					WS02-SPTC1-V2	
	SPU Unit Data Management Middleware	Function: Data files collected by SPU Unit Data Management Middleware are automatically acquired at the personal computer, and can be registered in a database.				1 license	WS02-EDMC1-V2	---
		OS: Microsoft Windows 10 (32 bit/64 bit) Microsoft Windows 8.1 (32 bit/64 bit) Microsoft Windows 8 (32 bit/64 bit) Microsoft Windows 7 (32 bit/64 bit) Microsoft Windows Server 2012 Microsoft Windows Server 2008				5 licenses	WS02-EDMC1-V2L05	
	Memory Cards	Flash memory, 128 MB			Note: Memory Card is required for data collection.	HMC-EF183		---
	Flash memory, 256 MB			HMC-EF283				
	Flash memory, 512 MB			HMC-EF583				

Terms and Conditions Agreement

Read and understand this catalog.

Please read and understand this catalog before purchasing the products. Please consult your OMRON representative if you have any questions or comments.

Warranties.

- (a) Exclusive Warranty. Omron's exclusive warranty is that the Products will be free from defects in materials and workmanship for a period of twelve months from the date of sale by Omron (or such other period expressed in writing by Omron). Omron disclaims all other warranties, express or implied.
- (b) Limitations. OMRON MAKES NO WARRANTY OR REPRESENTATION, EXPRESS OR IMPLIED, ABOUT NON-INFRINGEMENT, MERCHANTABILITY OR FITNESS FOR A PARTICULAR PURPOSE OF THE PRODUCTS. BUYER ACKNOWLEDGES THAT IT ALONE HAS DETERMINED THAT THE PRODUCTS WILL SUITABLY MEET THE REQUIREMENTS OF THEIR INTENDED USE.

Omron further disclaims all warranties and responsibility of any type for claims or expenses based on infringement by the Products or otherwise of any intellectual property right. (c) Buyer Remedy. Omron's sole obligation hereunder shall be, at Omron's election, to (i) replace (in the form originally shipped with Buyer responsible for labor charges for removal or replacement thereof) the non-complying Product, (ii) repair the non-complying Product, or (iii) repay or credit Buyer an amount equal to the purchase price of the non-complying Product; provided that in no event shall Omron be responsible for warranty, repair, indemnity or any other claims or expenses regarding the Products unless Omron's analysis confirms that the Products were properly handled, stored, installed and maintained and not subject to contamination, abuse, misuse or inappropriate modification. Return of any Products by Buyer must be approved in writing by Omron before shipment. Omron Companies shall not be liable for the suitability or unsuitability or the results from the use of Products in combination with any electrical or electronic components, circuits, system assemblies or any other materials or substances or environments. Any advice, recommendations or information given orally or in writing, are not to be construed as an amendment or addition to the above warranty.

See <http://www.omron.com/global/> or contact your Omron representative for published information.

Limitation on Liability; Etc.

OMRON COMPANIES SHALL NOT BE LIABLE FOR SPECIAL, INDIRECT, INCIDENTAL, OR CONSEQUENTIAL DAMAGES, LOSS OF PROFITS OR PRODUCTION OR COMMERCIAL LOSS IN ANY WAY CONNECTED WITH THE PRODUCTS, WHETHER SUCH CLAIM IS BASED IN CONTRACT, WARRANTY, NEGLIGENCE OR STRICT LIABILITY.

Further, in no event shall liability of Omron Companies exceed the individual price of the Product on which liability is asserted.

Suitability of Use.

Omron Companies shall not be responsible for conformity with any standards, codes or regulations which apply to the combination of the Product in the Buyer's application or use of the Product. At Buyer's request, Omron will provide applicable third party certification documents identifying ratings and limitations of use which apply to the Product. This information by itself is not sufficient for a complete determination of the suitability of the Product in combination with the end product, machine, system, or other application or use. Buyer shall be solely responsible for determining appropriateness of the particular Product with respect to Buyer's application, product or system. Buyer shall take application responsibility in all cases.

NEVER USE THE PRODUCT FOR AN APPLICATION INVOLVING SERIOUS RISK TO LIFE OR PROPERTY OR IN LARGE QUANTITIES WITHOUT ENSURING THAT THE SYSTEM AS A WHOLE HAS BEEN DESIGNED TO ADDRESS THE RISKS, AND THAT THE OMRON PRODUCT(S) IS PROPERLY RATED AND INSTALLED FOR THE INTENDED USE WITHIN THE OVERALL EQUIPMENT OR SYSTEM.

Programmable Products.

Omron Companies shall not be responsible for the user's programming of a programmable Product, or any consequence thereof.

Performance Data.

Data presented in Omron Company websites, catalogs and other materials is provided as a guide for the user in determining suitability and does not constitute a warranty. It may represent the result of Omron's test conditions, and the user must correlate it to actual application requirements. Actual performance is subject to the Omron's Warranty and Limitations of Liability.

Change in Specifications.

Product specifications and accessories may be changed at any time based on improvements and other reasons. It is our practice to change part numbers when published ratings or features are changed, or when significant construction changes are made. However, some specifications of the Product may be changed without any notice. When in doubt, special part numbers may be assigned to fix or establish key specifications for your application. Please consult with your Omron's representative at any time to confirm actual specifications of purchased Product.

Errors and Omissions.

Information presented by Omron Companies has been checked and is believed to be accurate; however, no responsibility is assumed for clerical, typographical or proofreading errors or omissions.

Note: Do not use this document to operate the Unit.

OMRON Corporation Industrial Automation Company
Tokyo, JAPAN

Contact: www.ia.omron.com

Regional Headquarters

OMRON EUROPE B.V.

Wegalaan 67-69-2132 JD Hoofddorp
The Netherlands
Tel: (31)2356-81-300/Fax: (31)2356-81-388

OMRON ELECTRONICS LLC

One Commerce Drive Schaumburg,
IL 60173-5302 U.S.A.
Tel: (1) 847-843-7900/Fax: (1) 847-843-7787

OMRON ASIA PACIFIC PTE. LTD.

No. 438A Alexandra Road # 05-05/08 (Lobby 2),
Alexandra Technopark,
Singapore 119967
Tel: (65) 6835-3011/Fax: (65) 6835-2711

OMRON (CHINA) CO., LTD.

Room 2211, Bank of China Tower,
200 Yin Cheng Zhong Road,
PuDong New Area, Shanghai, 200120, China
Tel: (86) 21-5037-2222/Fax: (86) 21-5037-2200

Authorized Distributor:

© OMRON Corporation 2008-2021 All Rights Reserved.
In the interest of product improvement,
specifications are subject to change without notice.

CSM_17_14
Cat. No. P059-E1-16

0721 (0908)