

TINA3-WWW

~70° wide beam. Assembly with holder, installation tape and location pins.

TECHNICAL SPECIFICATIONS:

Dimensions	Ø 16.1 mm
Height	6.9 mm
Fastening	tape, pin
Colour	white
Box size	451 x 241 x 298 mm
Box weight	8.3 kg
Quantity in Box	5750 pcs
ROHS compliant	yes ⓘ

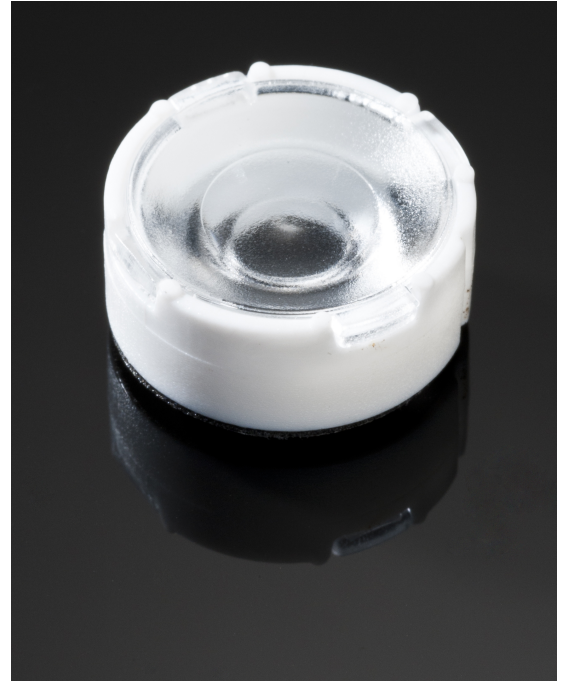

MATERIAL SPECIFICATIONS:

Component	Type	Material	Colour
TINA3-WWW	Single lens	PMMA	clear
TINA3-HLD-PIN-TAPE	Holder	PC	white
TINA-TAPE3	Tape	PU tape	

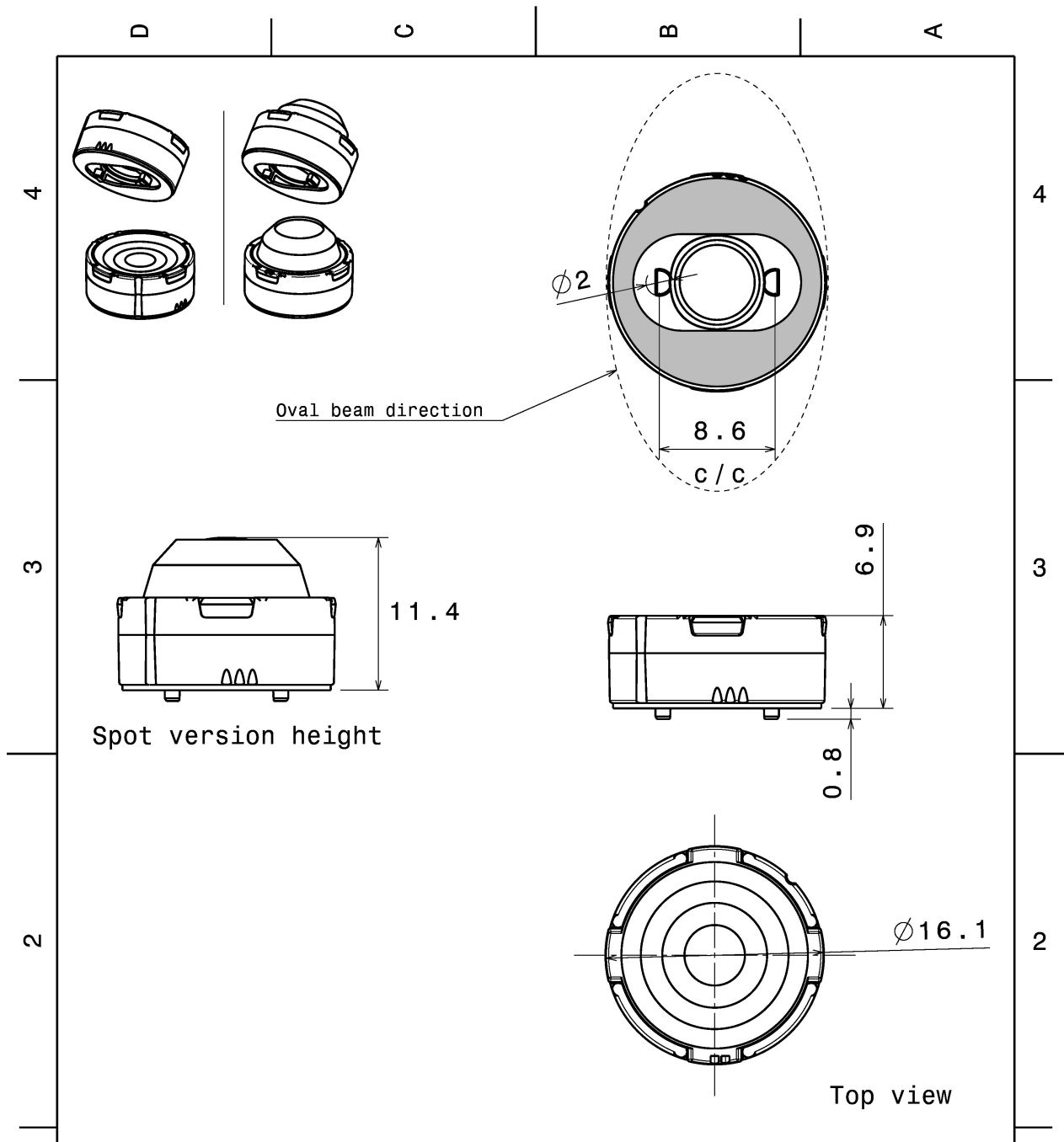

Tolerances if not otherwise shown
According to DIN ISO 2768-1
Linear measures:
Up to 30mm class M, otherwise class C.
According to DIN ISO 2768-2
Form and position: class L

LEDiL

Ledil Oy
Salorankatu 10
FIN 24240 SALO
Finland

THIRD ANGLE PROJECTION:

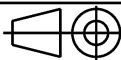

DRAWING TITLE

TINA3 Datasheet

This drawing is the property of LEDiL Oy. It may not be reproduced, copied or communicated without a written agreement with LEDiL Oy."

SIZE PART NUMBER

A4

-

SCALE 4:3 WEIGHT

-

SHEET 1/1

PHOTOMETRIC DATA (MEASURED):



LED XP-E2
FWHM 77.0°
Efficiency 88 %
Peak intensity 0.700 cd/lm
LEDs/each optic 1
Light colour White
Required components:

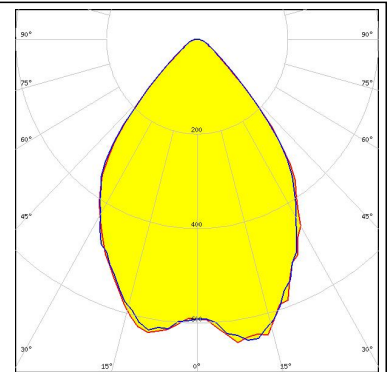
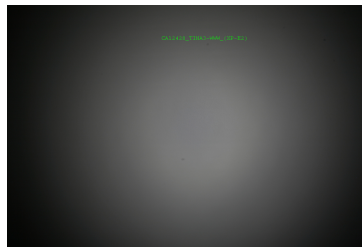

LED XP-G
FWHM 69.0°
Efficiency 87 %
Peak intensity 0.700 cd/lm
LEDs/each optic 1
Light colour White
Required components:

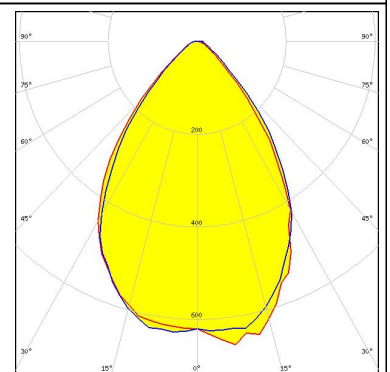

LED XP-G2
FWHM 76.0°
Efficiency 86 %
Peak intensity 0.600 cd/lm
LEDs/each optic 1
Light colour White
Required components:

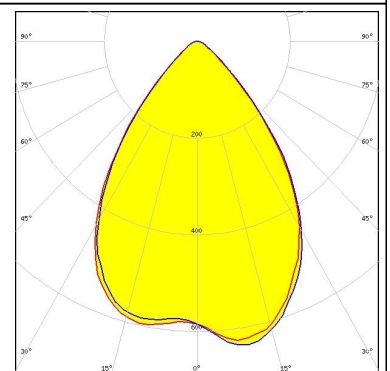
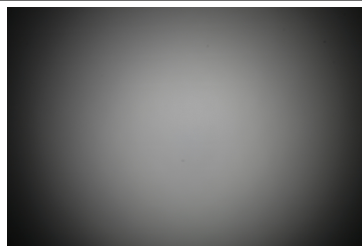

LED XP-L HI
FWHM 74.0°
Efficiency 91 %
Peak intensity 0.650 cd/lm
LEDs/each optic 1
Light colour White
Required components:

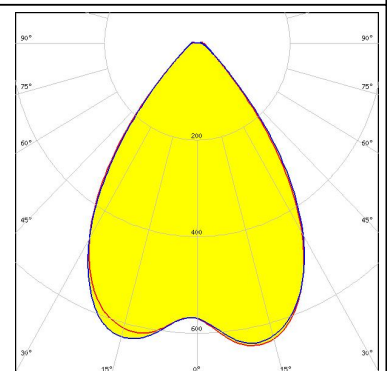
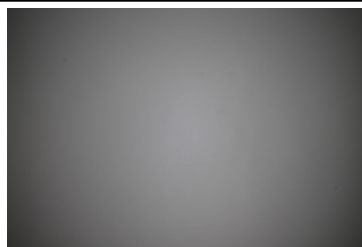

PHOTOMETRIC DATA (MEASURED):



LED XT-E
FWHM 68.0°
Efficiency 85 %
Peak intensity 0.700 cd/lm
LEDs/each optic 1
Light colour White
Required components:

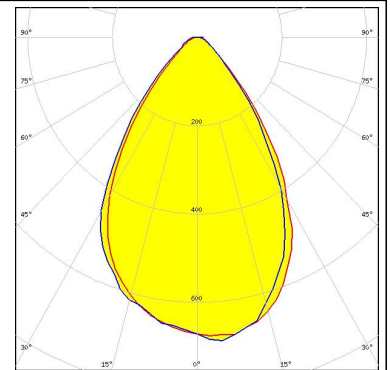

LED LUXEON A
FWHM 74.0°
Efficiency 86 %
Peak intensity 0.600 cd/lm
LEDs/each optic 1
Light colour White
Required components:

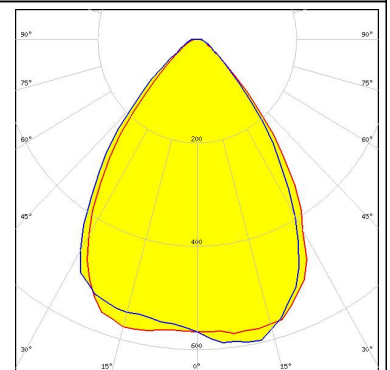

LED LUXEON T
FWHM 78.0°
Efficiency 86 %
Peak intensity 0.600 cd/lm
LEDs/each optic 1
Light colour White
Required components:

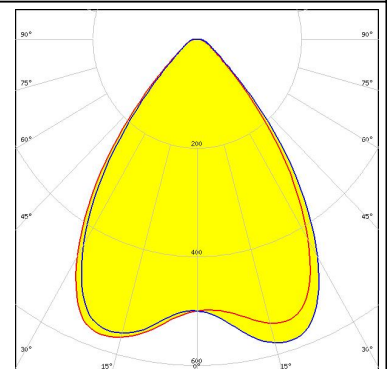
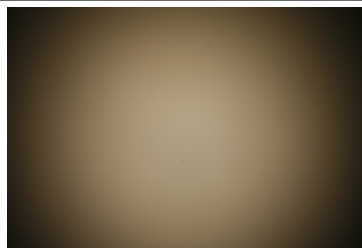

LED LUXEON TX
FWHM 79.0°
Efficiency 87 %
Peak intensity 0.560 cd/lm
LEDs/each optic 1
Light colour White
Required components:

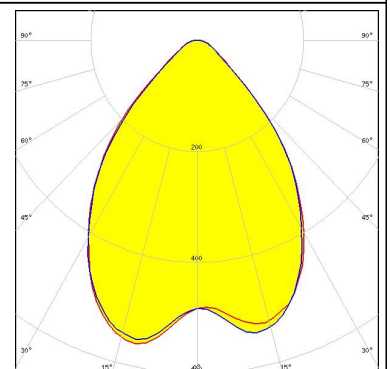
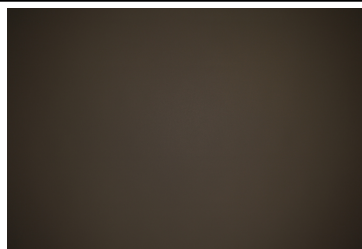

PHOTOMETRIC DATA (MEASURED):



LED NVSxx19A
FWHM 75.0°
Efficiency 83 %
Peak intensity 0.600 cd/lm
LEDs/each optic 1
Light colour White
Required components:

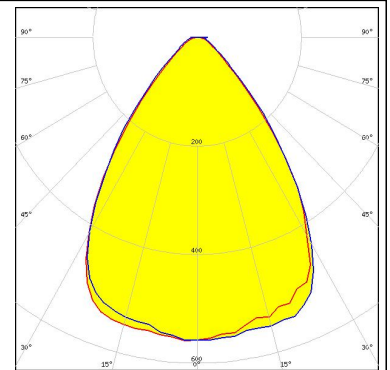

LED NVSxx19B/NVSxx19C
FWHM 79.0°
Efficiency 90 %
Peak intensity 0.570 cd/lm
LEDs/each optic 1
Light colour White
Required components:

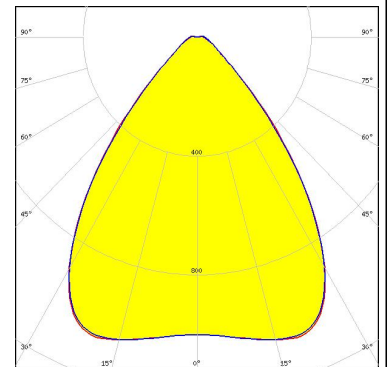

Opto Semiconductors

LED OSOLON Square EC
FWHM 75.0°
Efficiency 84 %
Peak intensity 0.600 cd/lm
LEDs/each optic 1
Light colour White
Required components:

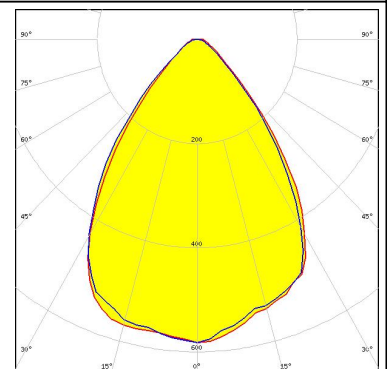

LED LH351B
FWHM 76.0°
Efficiency 86 %
Peak intensity 0.600 cd/lm
LEDs/each optic 1
Light colour White
Required components:

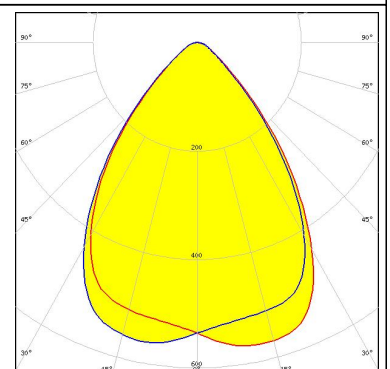
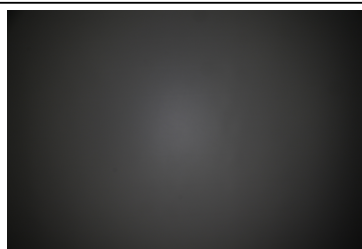

PHOTOMETRIC DATA (MEASURED):

SAMSUNG

LED LH351Z
FWHM 85.0°
Efficiency 87 %
Peak intensity 0.510 cd/m
LEDs/each optic 1
Light colour White
Required components:

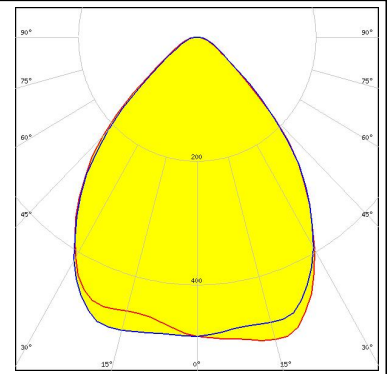

PHOTOMETRIC DATA (SIMULATED):



LED LUXEON 2835 Line
FWHM 80.0°
Efficiency 93 %
Peak intensity 0.599 cd/lm
LEDs/each optic 1
Light colour White
Required components:

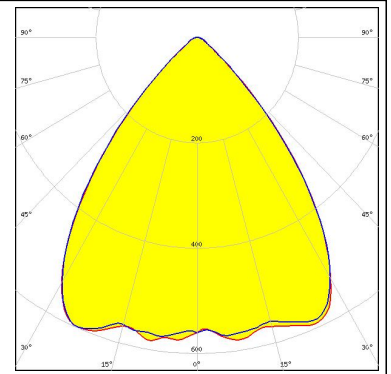

GENERAL INFORMATION:

NOTE: The typical beam angle will be changed by different color, chip size and chip position tolerance. The typical total beam angle is the full angle measured where the luminous intensity is half of the peak value.

MATERIALS:

As part of our continuous research and improvement processes, and to ensure the best possible quality and availability of our products, LEDiL reserves the right to change material grades without notice.

PRODUCT DATA USER AGREEMENT AND DISCLAIMER:

The measured data in the provided downloadable LEDiL Product Datasheets and Mechanical 2D-Drawings is rounded and provided as reference for planning. LEDiL Oy's optical specifications have been verified by conducting performance testing of the products in accordance with the company's quality system. The reported data are averaged results of multiple measurements with typical variation. LEDiL Oy reserves the right to without prior notification make changes and improvements to its products.

LEDiL Oy assumes neither warranty, nor guarantee nor any other liability of any kind for the contents and correctness of the provided data. The provided data has been generated with highest diligence but the provided data may in reality not represent the complete possible variation range of all intrinsic parameters. Therefore, in certain cases a deviation from the provided data could occur.

LEDiL Oy reserves the right to undertake technical changes of its products without further notification which could lead to changes in the provided data. LEDiL Oy assumes no liability of any kind for the possible deviation from any provided data or any other damage resulting from the usage of the provided data.

The user agrees to this disclaimer and user agreement with the download or usage of the provided files.

LEDiL Oy

Joensuunkatu 13
FI-24240 SALO
Finland

LEDiL Inc.

228 West Page Street
Suite D
Sycamore IL 60178
USA

Local sales and technical support

[www.ledil.com/
where_to_buy](http://www.ledil.com/where_to_buy)

Shipping locations

Salo, Finland
Hong Kong, China

Distribution Partners

[www.ledil.com/
where_to_buy](http://www.ledil.com/where_to_buy)