

LENINA-M

~30° medium beam

TECHNICAL SPECIFICATIONS:

Dimensions	Ø 74.0 mm
Height	40 mm
Fastening	socket
Colour	metal
Box size	476 x 273 x 197 mm
Box weight	2 kg
Quantity in Box	60 pcs
ROHS compliant	yes ⓘ



MATERIAL SPECIFICATIONS:



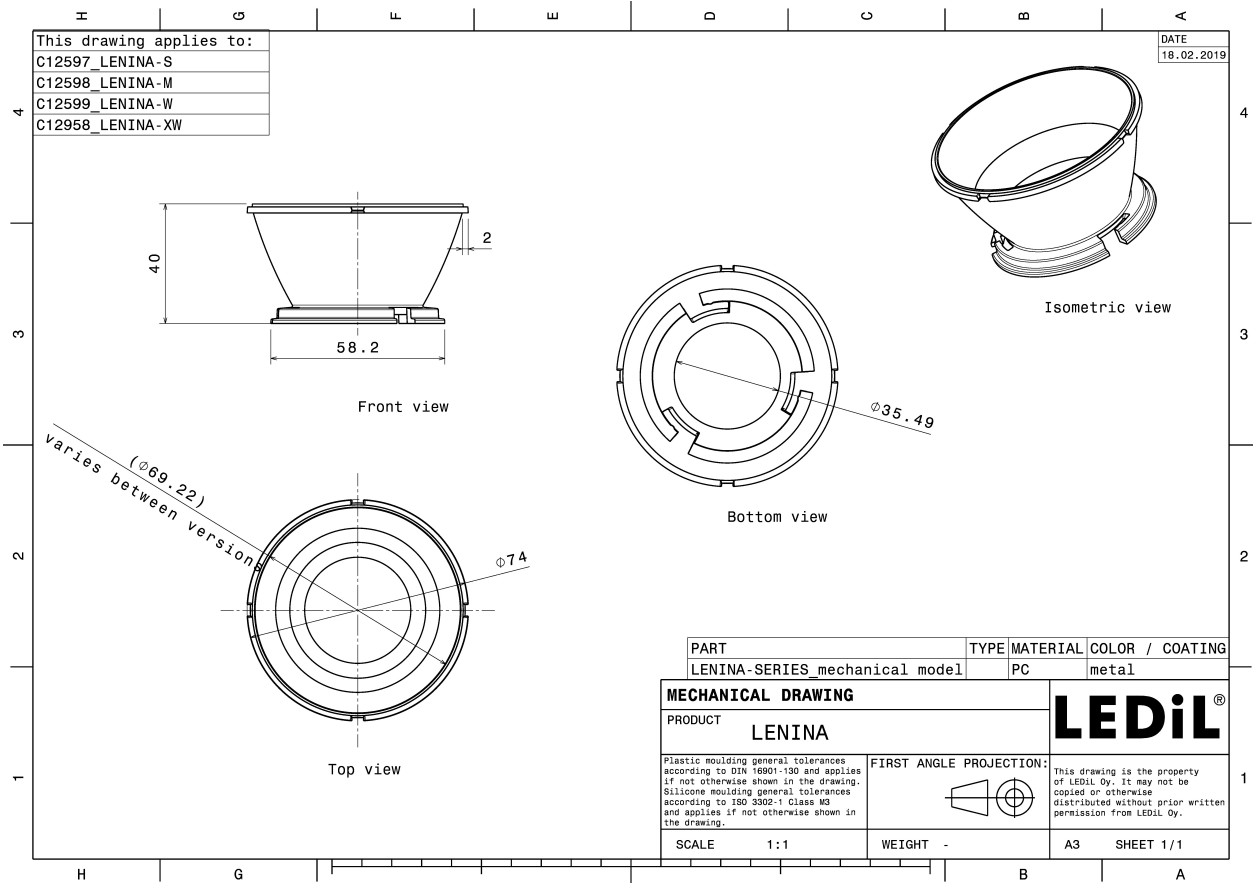

Component	Type	Material	Colour	Coating
LENINA-M	Reflector	PC	metal	lacquer

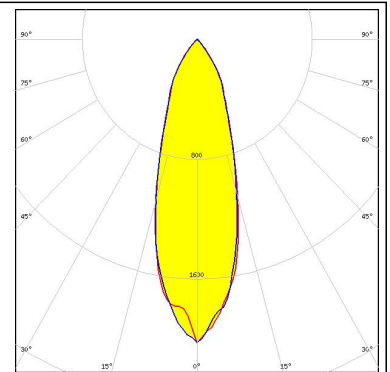
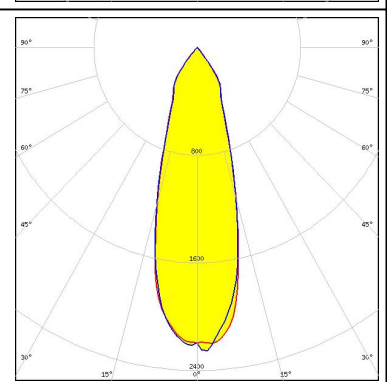
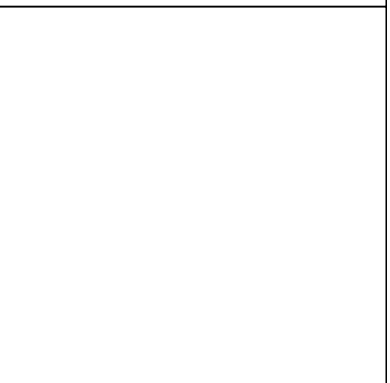
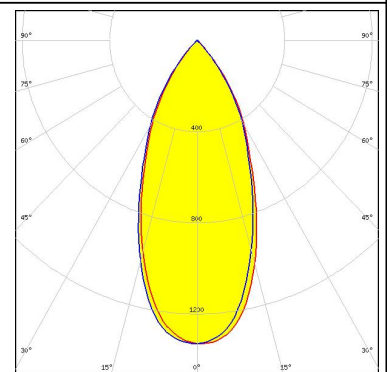

PHOTOMETRIC DATA (MEASURED):

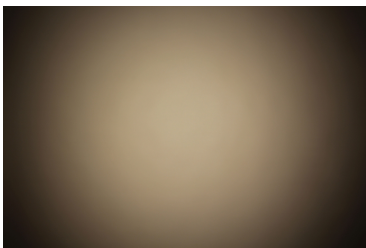
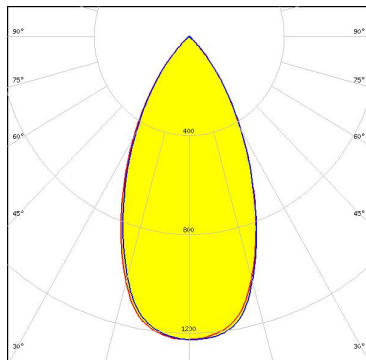
<p>bridgelux.</p> <p>LED BXRA ES Rectangle</p> <p>FWHM 36.0°</p> <p>Efficiency 78 %</p> <p>Peak intensity cd/lm</p> <p>LEDs/each optic 1</p> <p>Light colour White</p> <p>Required components:</p> <p>C12153_LENINA-STD-BASE-BXRA</p> <p>C12606_LENINA-DL</p>	
<p>bridgelux.</p> <p>LED BXRA ES Rectangle</p> <p>FWHM 29.0°</p> <p>Efficiency 86 %</p> <p>Peak intensity cd/lm</p> <p>LEDs/each optic 1</p> <p>Light colour White</p> <p>Required components:</p> <p>C12153_LENINA-STD-BASE-BXRA</p>	
<p>bridgelux.</p> <p>LED BXRA RS</p> <p>FWHM 47.0°</p> <p>Efficiency 80 %</p> <p>Peak intensity 1.220 cd/lm</p> <p>LEDs/each optic 1</p> <p>Light colour White</p> <p>Required components:</p> <p>C12229_LENINA-STD-BASE-RS</p> <p>C12606_LENINA-DL</p>	
<p>bridgelux.</p> <p>LED BXRA RS</p> <p>FWHM 44.0°</p> <p>Efficiency 88 %</p> <p>Peak intensity 1.373 cd/lm</p> <p>LEDs/each optic 1</p> <p>Light colour White</p> <p>Required components:</p> <p>C12229_LENINA-STD-BASE-RS</p>	

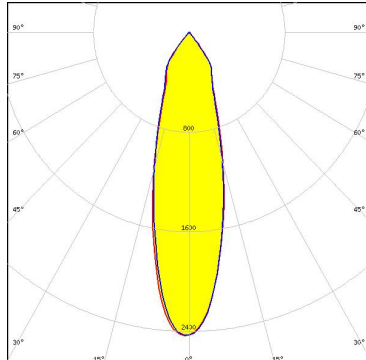
PHOTOMETRIC DATA (MEASURED):

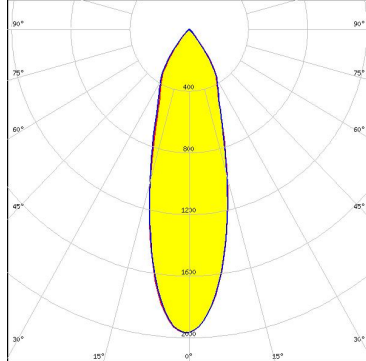
<p>bridgelux.</p> <p>LED V10 Gen6 FWHM 21.0° Efficiency 84 % Peak intensity 3.170 cd/lm LEDs/each optic 1 Light colour White Required components: C13186_LENINA-STD-BASE-CXA15 C12606_LENINA-DL</p>		
<p>bridgelux.</p> <p>LED Vero SE 29 FWHM 51.0° Efficiency 92 % Peak intensity 1.200 cd/lm LEDs/each optic 1 Light colour White Required components: C15083_LENINA-STD-BASE-VERO29</p>		
<p>bridgelux.</p> <p>LED VERO13 FWHM 28.0° Efficiency 91 % Peak intensity 2.400 cd/lm LEDs/each optic 1 Light colour White Required components: C13868_LENINA-STD-BASE-VERO13-18</p>		
<p>bridgelux.</p> <p>LED VERO13 FWHM 31.0° Efficiency 87 % Peak intensity 2.000 cd/lm LEDs/each optic 1 Light colour White Required components: C13868_LENINA-STD-BASE-VERO13-18 C12606_LENINA-DL</p>		

PHOTOMETRIC DATA (MEASURED):

<p>bridgelux.</p> <p>LED VERO18 FWHM 35.0° Efficiency 90 % Peak intensity 1.860 cd/lm LEDs/each optic 1 Light colour White Required components: C13868_LENINA-STD-BASE-VERO13-18</p>	
<p>bridgelux.</p> <p>LED VERO18 FWHM 37.0° Efficiency 86 % Peak intensity 1.600 cd/lm LEDs/each optic 1 Light colour White Required components: C13868_LENINA-STD-BASE-VERO13-18 C12606_LENINA-DL</p>	
<p>bridgelux.</p> <p>LED VERO29 FWHM 52.0° Efficiency 85 % Peak intensity 1.060 cd/lm LEDs/each optic 1 Light colour White Required components: C13867_LENINA-STD-BASE-VERO29 C12606_LENINA-DL</p>	
<p>bridgelux.</p> <p>LED VERO29 FWHM 52.0° Efficiency 89 % Peak intensity 1.160 cd/lm LEDs/each optic 1 Light colour White Required components: C13867_LENINA-STD-BASE-VERO29</p>	

PHOTOMETRIC DATA (MEASURED):

CITIZEN

LED CL-L340
FWHM 26.0°
Efficiency 92 %
Peak intensity 2.500 cd/lm
LEDs/each optic 1
Light colour White
Required components:
C11995_LENINA-STD-BASE-CL340

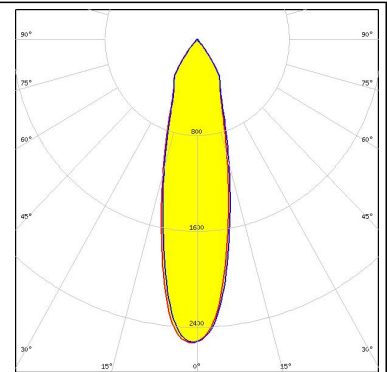
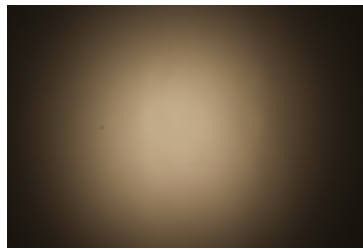

CITIZEN

LED CL-L340
FWHM 35.0°
Efficiency 78 %
Peak intensity cd/lm
LEDs/each optic 1
Light colour White
Required components:
C11995_LENINA-STD-BASE-CL340
C12606_LENINA-DL

CITIZEN

LED CL-L340
FWHM 30.0°
Efficiency 86 %
Peak intensity cd/lm
LEDs/each optic 1
Light colour White
Required components:
C11995_LENINA-STD-BASE-CL340

CITIZEN

LED CLL02x/CLU02x (LES10)
FWHM 23.0°
Efficiency 91 %
Peak intensity 3.000 cd/lm
LEDs/each optic 1
Light colour White
Required components:
C13868_LENINA-STD-BASE-VERO13-18
Bender Wirth: 434 Typ L1

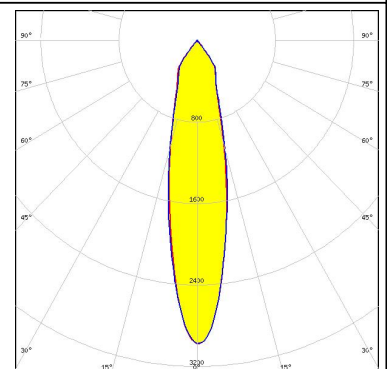
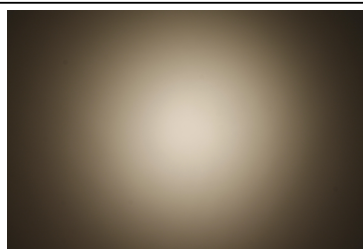

PHOTOMETRIC DATA (MEASURED):

CITIZEN

LED CLL02x/CLU02x (LES10)
 FWHM 26.0°
 Efficiency 87 %
 Peak intensity 2.300 cd/lm
 LEDs/each optic 1
 Light colour White
 Required components:
 C13868_LENINA-STD-BASE-VERO13-18
 C12606_LENINA-DL
 Bender Wirth: 434 Typ L1

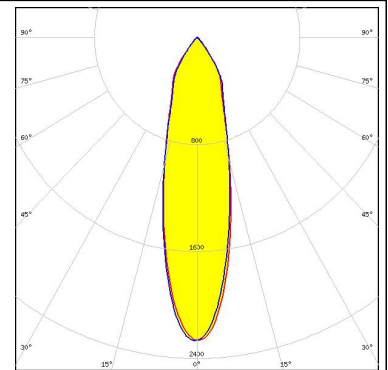
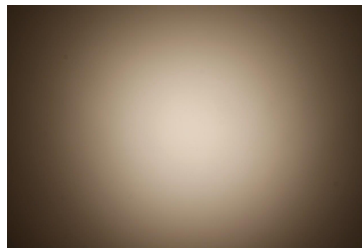

CITIZEN

LED CLL03x/CLU03x
 FWHM 28.0°
 Efficiency 91 %
 Peak intensity 2.400 cd/lm
 LEDs/each optic 1
 Light colour White
 Required components:
 C12691_LENINA-STD-BASE-CLL030

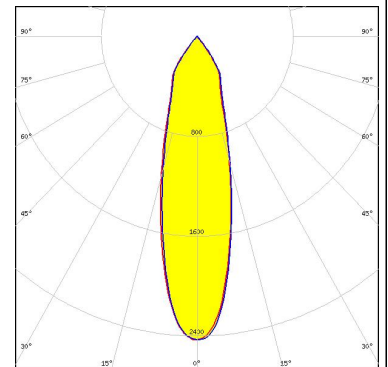
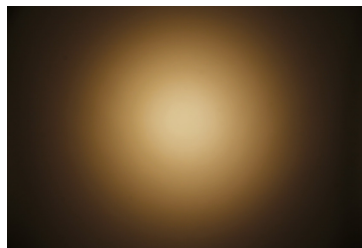

CITIZEN

LED CLL03x/CLU03x
 FWHM 29.0°
 Efficiency 91 %
 Peak intensity 2.300 cd/lm
 LEDs/each optic 1
 Light colour White
 Required components:
 C13868_LENINA-STD-BASE-VERO13-18
 Bender Wirth: 433 Typ L1

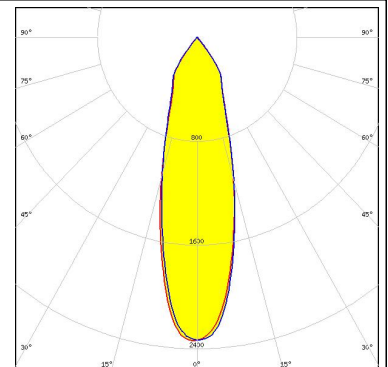
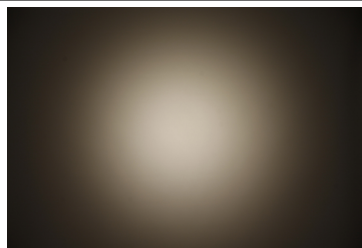

CITIZEN

LED CLL03x/CLU03x
 FWHM 30.0°
 Efficiency 87 %
 Peak intensity 2.000 cd/lm
 LEDs/each optic 1
 Light colour White
 Required components:
 C12691_LENINA-STD-BASE-CLL030
 C12606_LENINA-DL

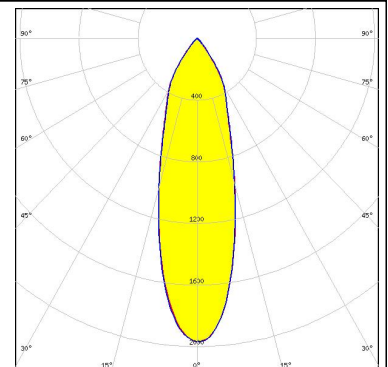
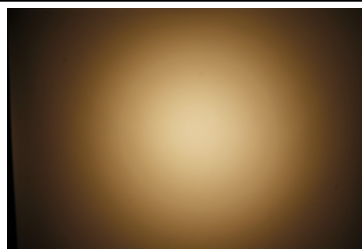

PHOTOMETRIC DATA (MEASURED):

CITIZEN

LED CLL03x/CLU03x
 FWHM 31.0°
 Efficiency 88 %
 Peak intensity 2.000 cd/lm
 LEDs/each optic 1
 Light colour White
 Required components:
 C13868_LENINA-STD-BASE-VERO13-18
 C12606_LENINA-DL
 Bender Wirth: 433 Typ L1

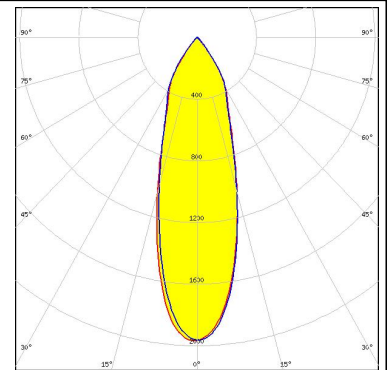
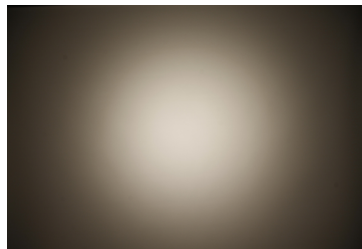

CITIZEN

LED CLL04x/CLU04x
 FWHM 38.0°
 Efficiency 76 %
 Peak intensity 1.400 cd/lm
 LEDs/each optic 1
 Light colour White
 Required components:
 C12606_LENINA-DL
 A.A.G. STUCCHI: 8102/G2 + S-8000/12

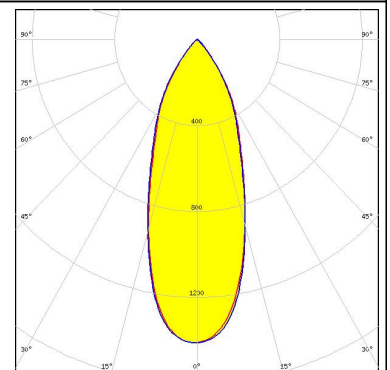
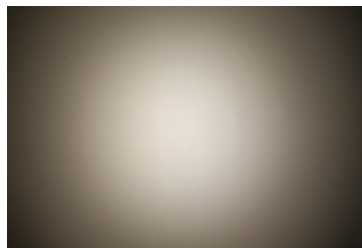

CITIZEN

LED CLL04x/CLU04x
 FWHM 40.0°
 Efficiency 86 %
 Peak intensity 1.500 cd/lm
 LEDs/each optic 1
 Light colour White
 Required components:
 C12692_LENINA-STD-BASE-CLL040

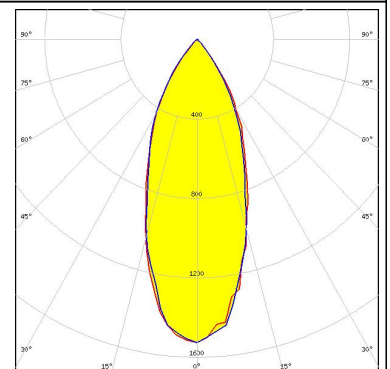
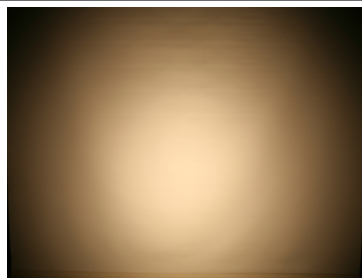

CITIZEN

LED CLL04x/CLU04x
 FWHM 37.0°
 Efficiency 87 %
 Peak intensity 1.600 cd/lm
 LEDs/each optic 1
 Light colour White
 Required components:
 C12606_LENINA-DL
 IDEAL: 50-2204CT + 50-2100LN

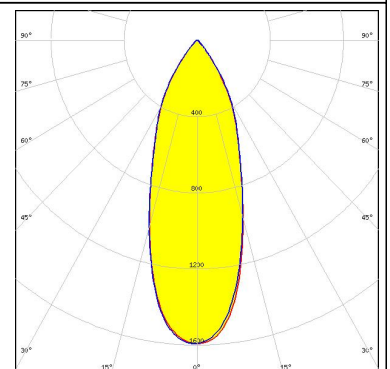

PHOTOMETRIC DATA (MEASURED):

CITIZEN

LED CLL04x/CLU04x
 FWHM 43.0°
 Efficiency 78 %
 Peak intensity 1.200 cd/lm
 LEDs/each optic 1
 Light colour White
 Required components:
 C12692_LENINA-STD-BASE-CLL040
 C12606_LENINA-DL

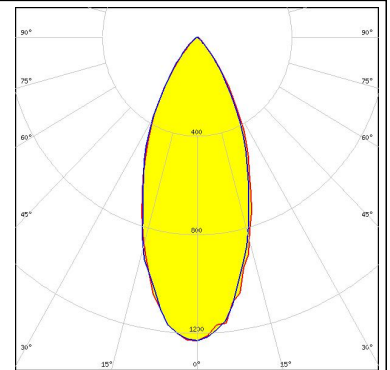

CITIZEN

LED CLL04x/CLU04x
 FWHM 40.0°
 Efficiency 87 %
 Peak intensity 1.400 cd/lm
 LEDs/each optic 1
 Light colour White
 Required components:
 C13867_LENINA-STD-BASE-VERO29
 C12606_LENINA-DL
 Bender Wirth: 431 Typ L3

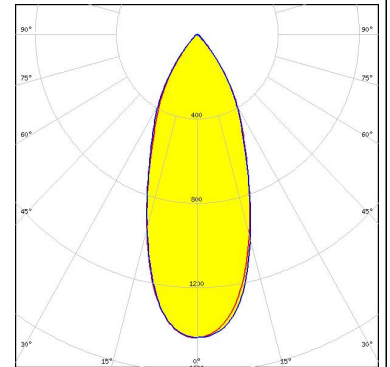
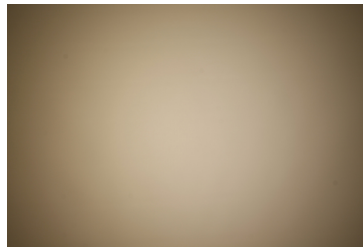

CITIZEN

LED CLL04x/CLU04x
 FWHM 36.0°
 Efficiency 83 %
 Peak intensity 1.600 cd/lm
 LEDs/each optic 1
 Light colour White
 Required components:
 A.A.G. STUCCHI: 8102/G2 + S-8000/12

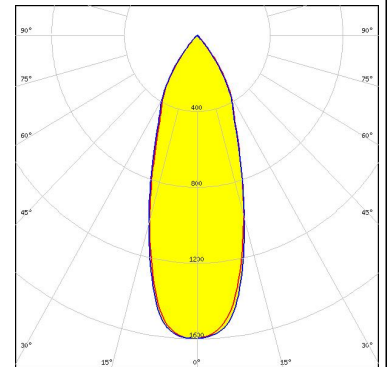
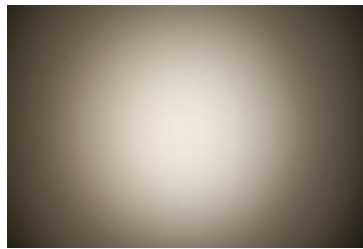

CITIZEN

LED CLL04x/CLU04x
 FWHM 39.0°
 Efficiency 92 %
 Peak intensity 1.700 cd/lm
 LEDs/each optic 1
 Light colour White
 Required components:
 C13867_LENINA-STD-BASE-VERO29
 Bender Wirth: 431 Typ L3

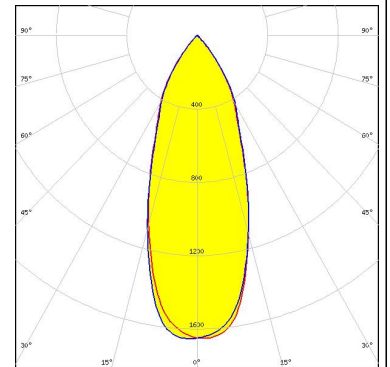
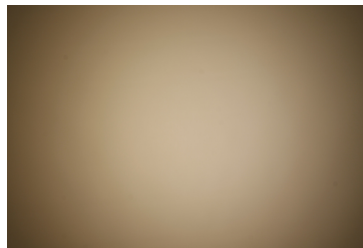

PHOTOMETRIC DATA (MEASURED):

CITIZEN

LED CLL04x/CLU04x
 FWHM 35.0°
 Efficiency 90 %
 Peak intensity 1.800 cd/lm
 LEDs/each optic 1
 Light colour White
 Required components:
 IDEAL: 50-2204CT + 50-2100LN

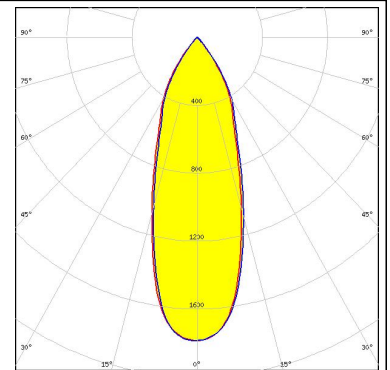

CITIZEN

LED CLU700/701/702
 FWHM 17.0°
 Efficiency 91 %
 Peak intensity 3.800 cd/lm
 LEDs/each optic 1
 Light colour White
 Required components:
 C13868_LENINA-STD-BASE-VERO13-18
 Bender Wirth: 434 Typ L1

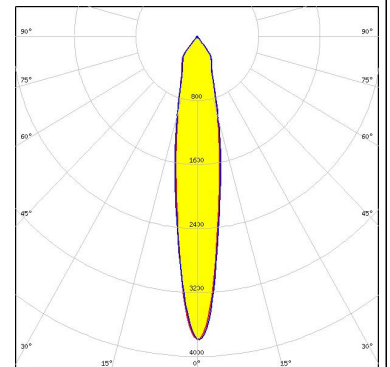
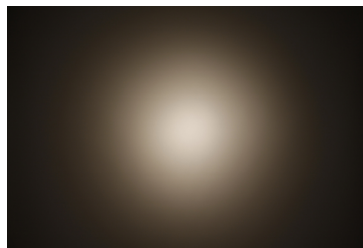

CITIZEN

LED CLU700/701/702
 FWHM 23.0°
 Efficiency 87 %
 Peak intensity 2.700 cd/lm
 LEDs/each optic 1
 Light colour White
 Required components:
 C13868_LENINA-STD-BASE-VERO13-18
 C12606_LENINA-DL
 Bender Wirth: 434 Typ L1

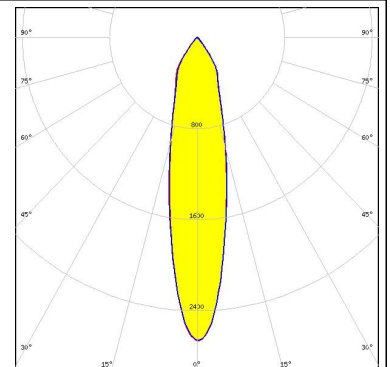
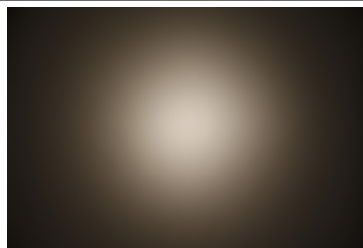

CITIZEN

LED CLU710/711
 FWHM 19.0°
 Efficiency 93 %
 Peak intensity 3.300 cd/lm
 LEDs/each optic 1
 Light colour White
 Required components:
 C12691_LENINA-STD-BASE-CLL030

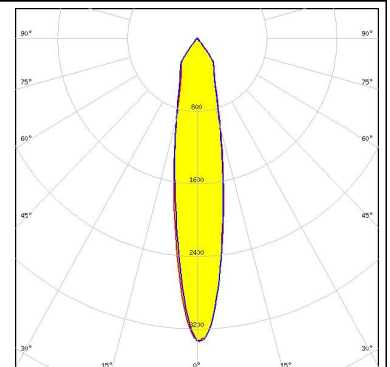
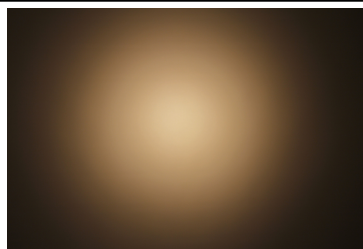

PHOTOMETRIC DATA (MEASURED):

CITIZEN

LED CLU710/711
 FWHM 24.0°
 Efficiency 89 %
 Peak intensity 2.400 cd/lm
 LEDs/each optic 1
 Light colour White
 Required components:
 C12691_LENINA-STD-BASE-CLL030
 C12606_LENINA-DL

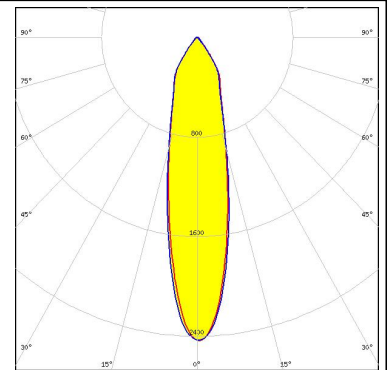
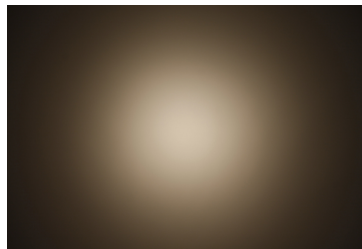

CITIZEN

LED CLU720/721
 FWHM 26.0°
 Efficiency 84 %
 Peak intensity 2.100 cd/lm
 LEDs/each optic 1
 Light colour White
 Required components:
 C12691_LENINA-STD-BASE-CLL030
 C12606_LENINA-DL

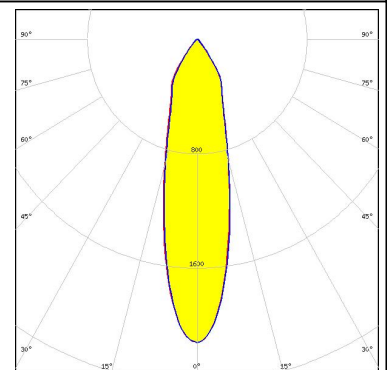
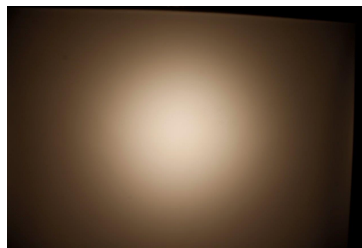

CITIZEN

LED CLU720/721
 FWHM 23.0°
 Efficiency 88 %
 Peak intensity 2.700 cd/lm
 LEDs/each optic 1
 Light colour White
 Required components:
 C12691_LENINA-STD-BASE-CLL030

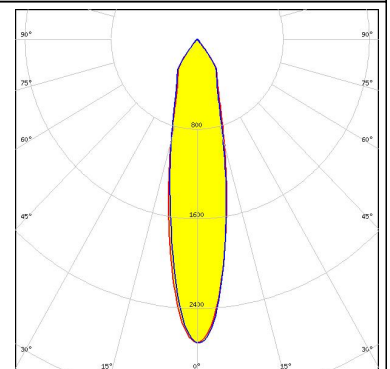
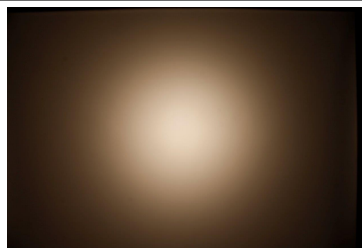

CITIZEN

LED CLU730/731
 FWHM 24.0°
 Efficiency 94 %
 Peak intensity 2.800 cd/lm
 LEDs/each optic 1
 Light colour White
 Required components:
 C12692_LENINA-STD-BASE-CLL040

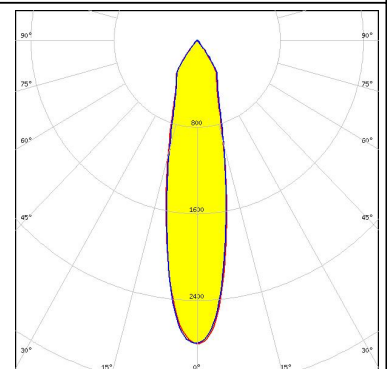
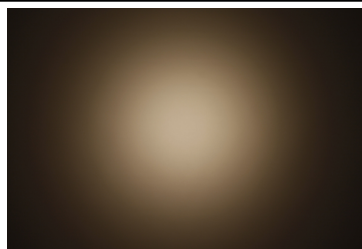

PHOTOMETRIC DATA (MEASURED):

CITIZEN

LED CLU730/731
 FWHM 26.0°
 Efficiency 84 %
 Peak intensity 2.100 cd/lm
 LEDs/each optic 1
 Light colour White
 Required components:
 C12692_LENINA-STD-BASE-CLL040
 C12606_LENINA-DL

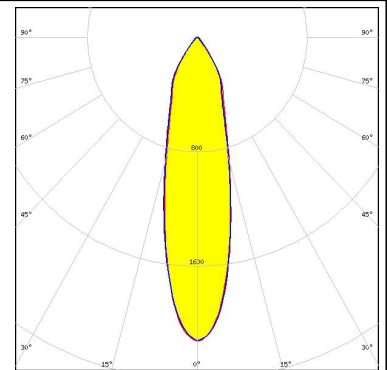
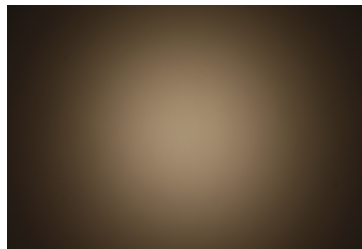

CREE

LED CMA1840
 FWHM 25.0°
 Efficiency 92 %
 Peak intensity 2.700 cd/lm
 LEDs/each optic 1
 Light colour White
 Required components:
 C14146_LENINA-STD-BASE-CXA18

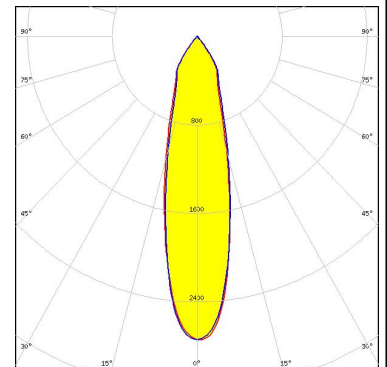
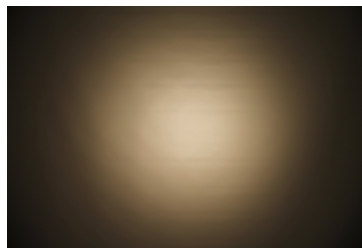

CREE

LED CMA1840
 FWHM 25.0°
 Efficiency 92 %
 Peak intensity 2.700 cd/lm
 LEDs/each optic 1
 Light colour White
 Required components:
 C14146_LENINA-STD-BASE-CXA18

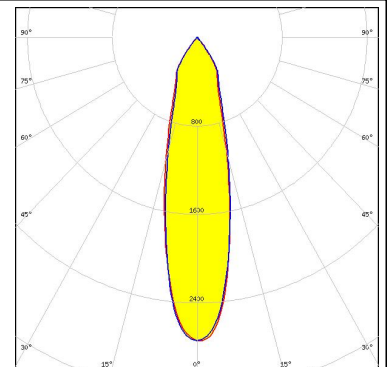
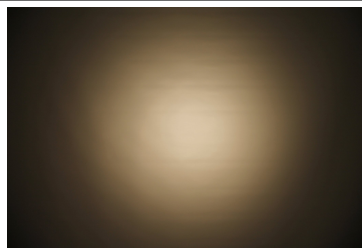

CREE

LED CMA2550
 FWHM 32.0°
 Efficiency 92 %
 Peak intensity 2.100 cd/lm
 LEDs/each optic 1
 Light colour White
 Required components:
 C13324_LENINA-STD-BASE-CXA25

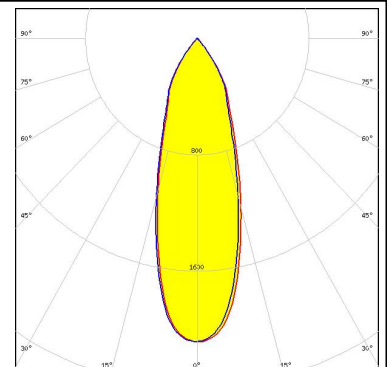
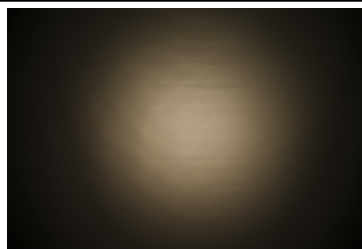

PHOTOMETRIC DATA (MEASURED):

CREE 

LED CMT14xx
FWHM 25.0°
Efficiency 92 %
Peak intensity 2.800 cd/lm
LEDs/each optic 1
Light colour White

Required components:
C13868_LENASTD-BASE-VERO13-18
Bender Wirth: 434 Typ L1

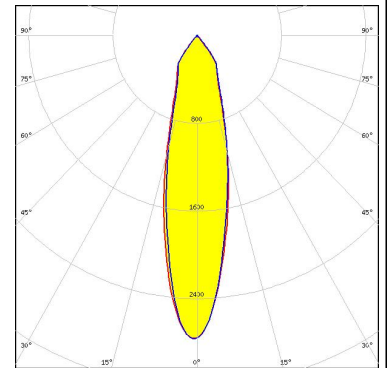

CREE 

LED CMT19xx
FWHM 29.0°
Efficiency 92 %
Peak intensity 2.367 cd/lm
LEDs/each optic 1
Light colour White

Required components:
C12691_LENASTD-BASE-CLL030



CREE 

LED CMT19xx
FWHM 30.0°
Efficiency 92 %
Peak intensity 2.286 cd/lm
LEDs/each optic 1
Light colour White

Required components:
C13868_LENASTD-BASE-VERO13-18
Bender Wirth: 477 Typ L1

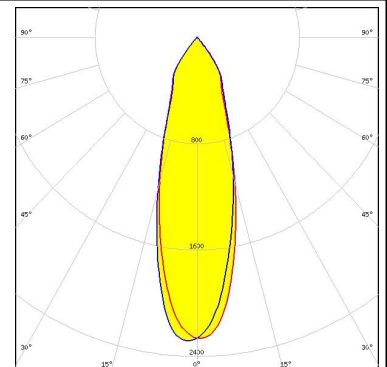
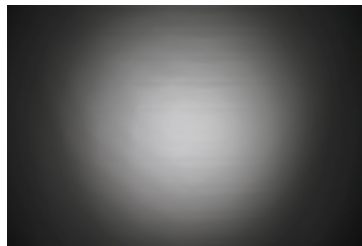

CREE 

LED CMT28xx
FWHM 39.0°
Efficiency 92 %
Peak intensity 1.650 cd/lm
LEDs/each optic 1
Light colour White

Required components:
C13867_LENASTD-BASE-VERO29
Bender Wirth: 471 Typ L3

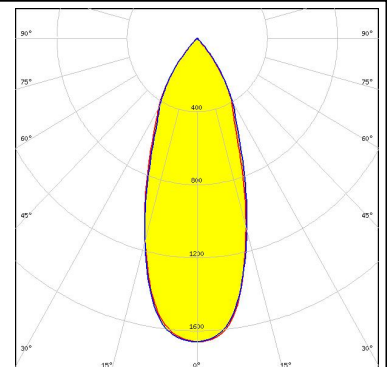
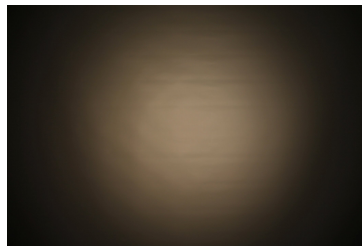

PHOTOMETRIC DATA (MEASURED):



LED CMT28xx
 FWHM 37.0°
 Efficiency 92 %
 Peak intensity 1.750 cd/lm
 LEDs/each optic 1
 Light colour White
 Required components:
 C12692_LENINA-STD-BASE-CLL040

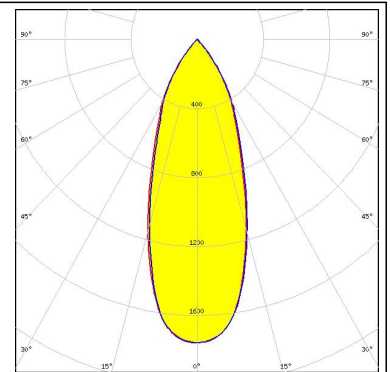
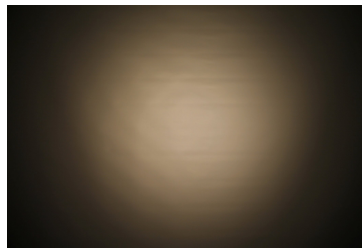

LED CXA/B 15xx
 FWHM 22.0°
 Efficiency %
 Peak intensity 3.100 cd/lm
 LEDs/each optic 1
 Light colour White
 Required components:
 C13868_LENINA-STD-BASE-VERO13-18
 Bender Wirth: 441 Typ L1

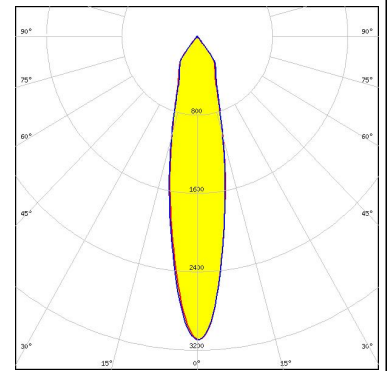
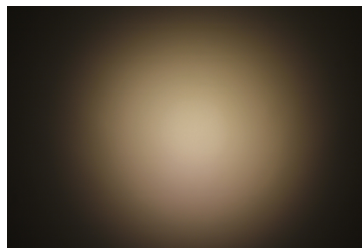

LED CXA/B 15xx
 FWHM 22.0°
 Efficiency 86 %
 Peak intensity 3.200 cd/lm
 LEDs/each optic 1
 Light colour White
 Required components:
 C13186_LENINA-STD-BASE-CXA15
 C12606_LENINA-DL

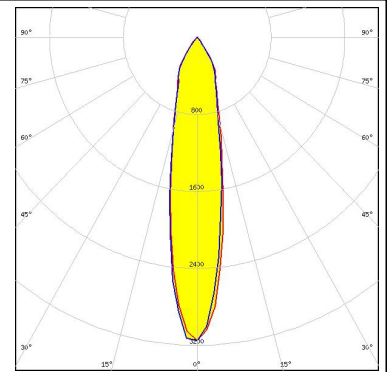
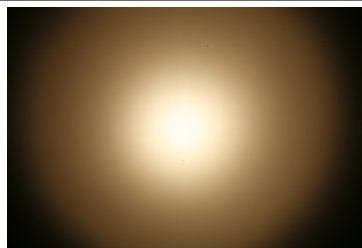

LED CXA/B 15xx
 FWHM 17.0°
 Efficiency 91 %
 Peak intensity 4.050 cd/lm
 LEDs/each optic 1
 Light colour White
 Required components:
 C13186_LENINA-STD-BASE-CXA15

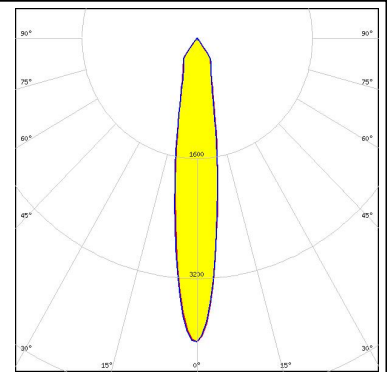

PHOTOMETRIC DATA (MEASURED):

CREE 

LED CXA/B 15xx
 FWHM 26.0°
 Efficiency 87 %
 Peak intensity 2.300 cd/lm
 LEDs/each optic 1
 Light colour White
 Required components:
 C13868_LENINA-STD-BASE-VERO13-18
 C12606_LENINA-DL
 Bender Wirth: 441 Typ L1

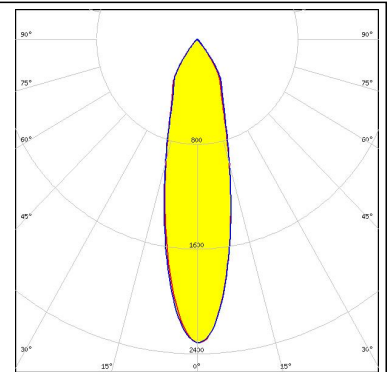
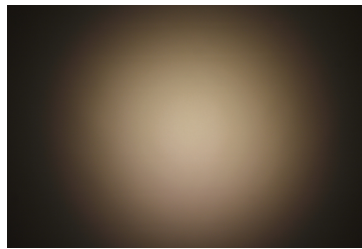

CREE 

LED CXA/B 1816 & CXA/B 1820 & CXA 1850
 FWHM 29.0°
 Efficiency 88 %
 Peak intensity 2.100 cd/lm
 LEDs/each optic 1
 Light colour White
 Required components:
 C13868_LENINA-STD-BASE-VERO13-18
 C12606_LENINA-DL
 Bender Wirth: 437 Typ L1

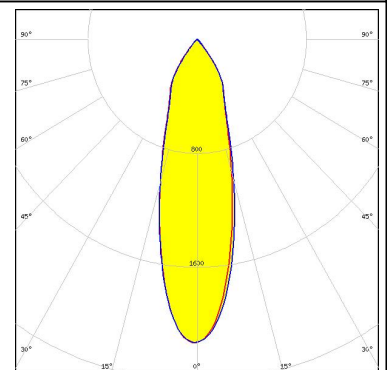
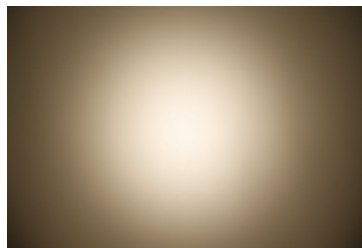

CREE 

LED CXA/B 1816 & CXA/B 1820 & CXA 1850
 FWHM 21.0°
 Efficiency 92 %
 Peak intensity 3.900 cd/lm
 LEDs/each optic 1
 Light colour White
 Required components:
 C14146_LENINA-STD-BASE-CXA18

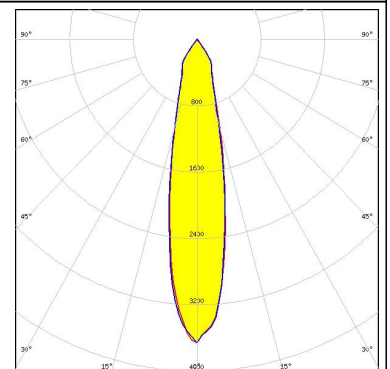
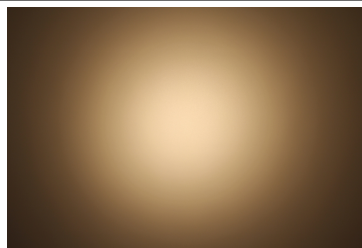

CREE 

LED CXA/B 1816 & CXA/B 1820 & CXA 1850
 FWHM 26.0°
 Efficiency 92 %
 Peak intensity 2.600 cd/lm
 LEDs/each optic 1
 Light colour White
 Required components:
 C13868_LENINA-STD-BASE-VERO13-18
 Bender Wirth: 437 Typ L1

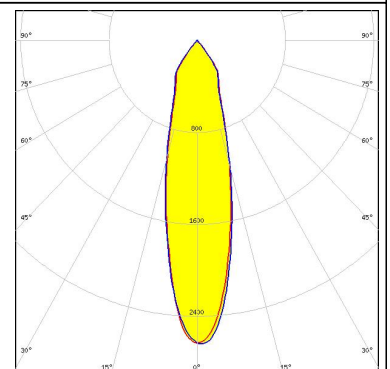
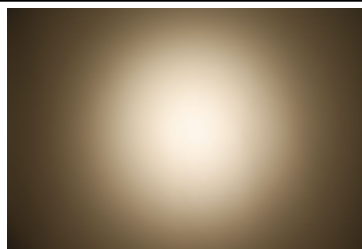

PHOTOMETRIC DATA (MEASURED):



LED CXA/B 1830
 FWHM 33.0°
 Efficiency 88 %
 Peak intensity 1.850 cd/lm
 LEDs/each optic 1
 Light colour White

Required components:
 C13868_LENINA-STD-BASE-VERO13-18
 C12606_LENINA-DL
 Bender Wirth: 437 Typ L1

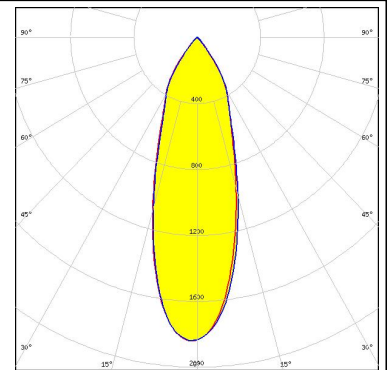

LED CXA/B 1830
 FWHM 30.0°
 Efficiency 93 %
 Peak intensity 2.250 cd/lm
 LEDs/each optic 1
 Light colour White

Required components:
 C13868_LENINA-STD-BASE-VERO13-18
 Bender Wirth: 437 Typ L1

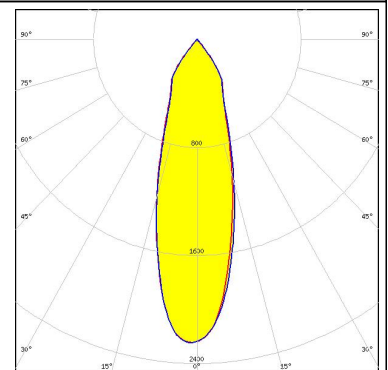
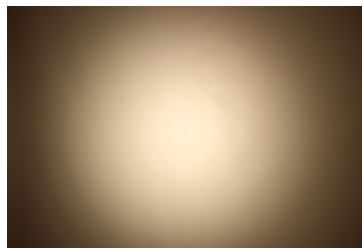

LED CXA/B 25xx
 FWHM 35.0°
 Efficiency 78 %
 Peak intensity 1.600 cd/lm
 LEDs/each optic 1
 Light colour White

Required components:
 C13324_LENINA-STD-BASE-CXA25
 C12606_LENINA-DL

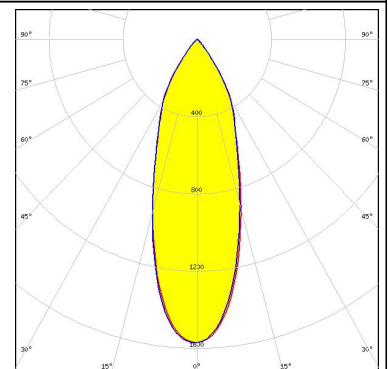
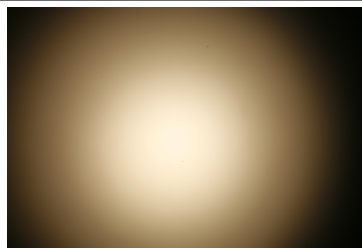

LED CXA/B 25xx
 FWHM 33.0°
 Efficiency 86 %
 Peak intensity 1.900 cd/lm
 LEDs/each optic 1
 Light colour White

Required components:
 C13324_LENINA-STD-BASE-CXA25

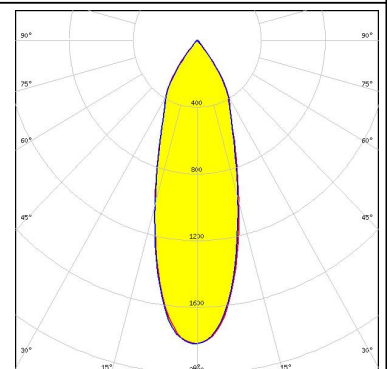
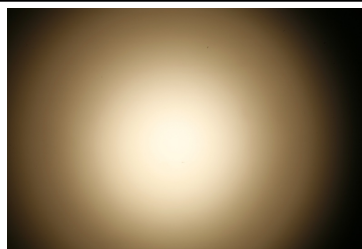

PHOTOMETRIC DATA (MEASURED):

CREE

LED CXA2011
 FWHM 33.0°
 Efficiency 77 %
 Peak intensity 1.800 cd/lm
 LEDs/each optic 1
 Light colour White
 Required components:
 C12105_LENINA-STD-BASE-CXA20
 C12606_LENINA-DL

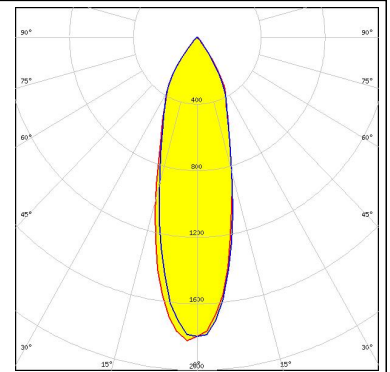

CREE

LED CXA2011
 FWHM 28.0°
 Efficiency 85 %
 Peak intensity 2.200 cd/lm
 LEDs/each optic 1
 Light colour White
 Required components:
 C12105_LENINA-STD-BASE-CXA20

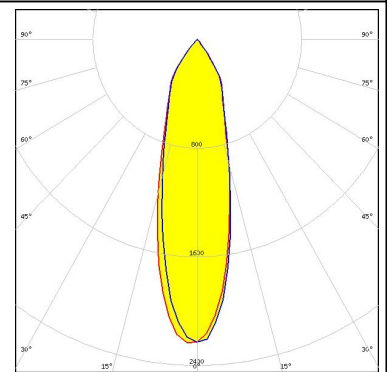

EVERLIGHT

LED CHI3030 19W
 FWHM 39.0°
 Efficiency 91 %
 Peak intensity 1.500 cd/lm
 LEDs/each optic 1
 Light colour White
 Required components:
 C13867_LENINA-STD-BASE-VERO29
 C12606_LENINA-DL
 Bender Wirth: 468 Typ L3

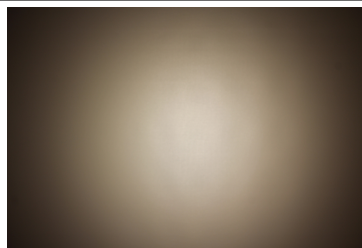



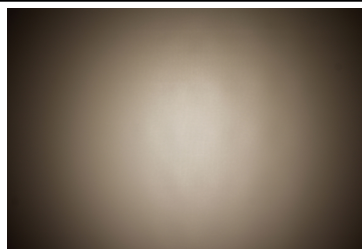

EVERLIGHT

LED CHI3030 29W
 FWHM 47.0°
 Efficiency 87 %
 Peak intensity 1.200 cd/lm
 LEDs/each optic 1
 Light colour White
 Required components:
 C13867_LENINA-STD-BASE-VERO29
 C12606_LENINA-DL
 Bender Wirth: 468 Typ L3

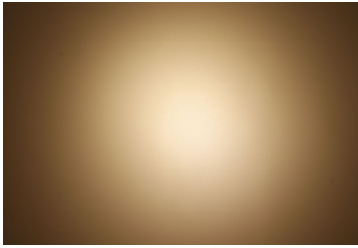
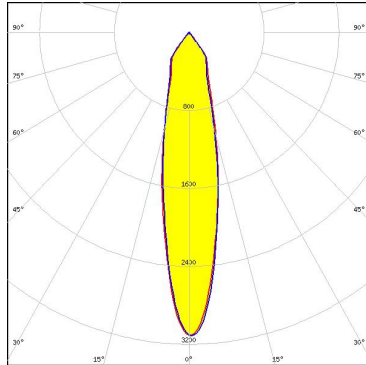
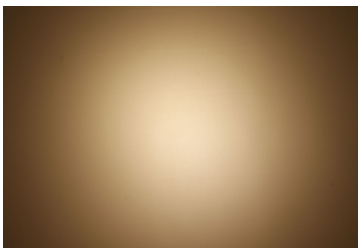
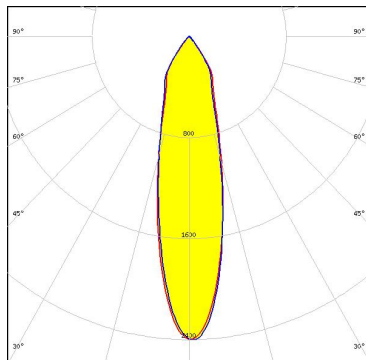

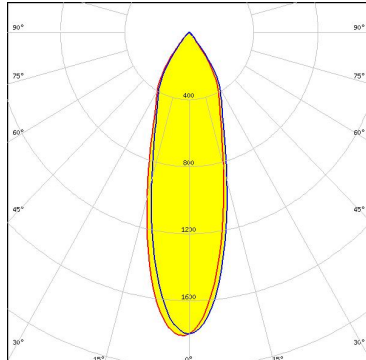
PHOTOMETRIC DATA (MEASURED):

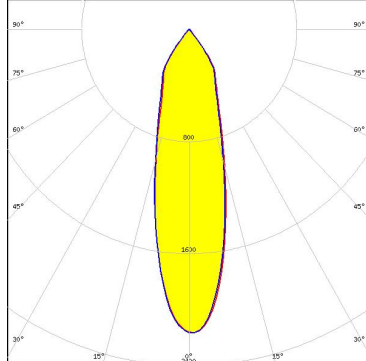
<p>LUMILEDS</p> <p>LED LUXEON CoB 1202/1203 FWHM 22.0° Efficiency 92 % Peak intensity 3.100 cd/lm LEDs/each optic 1 Light colour White Required components: C13868_LENASTD-BASE-VERO13-18 Bender Wirth: 438 Typ L1</p>		
<p>LUMILEDS</p> <p>LED LUXEON CoB 1202/1203 FWHM 26.0° Efficiency 88 % Peak intensity 2.400 cd/lm LEDs/each optic 1 Light colour White Required components: C13868_LENASTD-BASE-VERO13-18 C12606_LENINA-DL Bender Wirth: 438 Typ L1</p>		
<p>LUMILEDS</p> <p>LED LUXEON CoB 1204/1205 FWHM 30.0° Efficiency 82 % Peak intensity 1.800 cd/lm LEDs/each optic 1 Light colour White Required components: C12292_LENASTD-BASE-MEZ C12606_LENINA-DL</p>		
<p>LUMILEDS</p> <p>LED LUXEON CoB 1204/1205 FWHM 28.0° Efficiency 87 % Peak intensity 2.200 cd/lm LEDs/each optic 1 Light colour White Required components: C12292_LENASTD-BASE-MEZ</p>		

PHOTOMETRIC DATA (MEASURED):

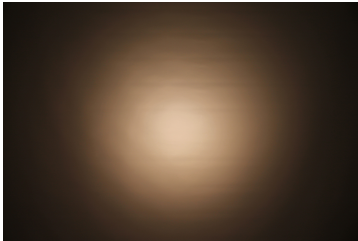
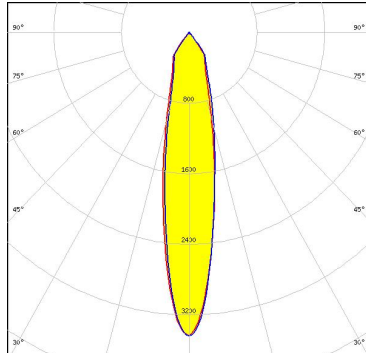
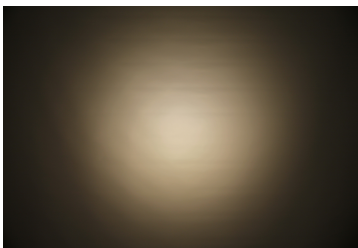
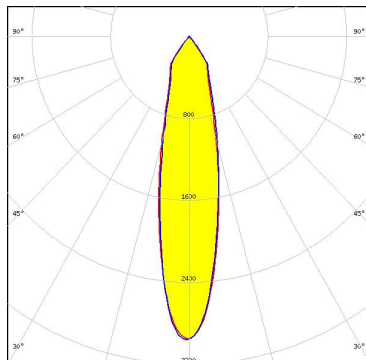
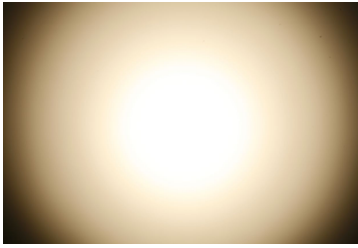
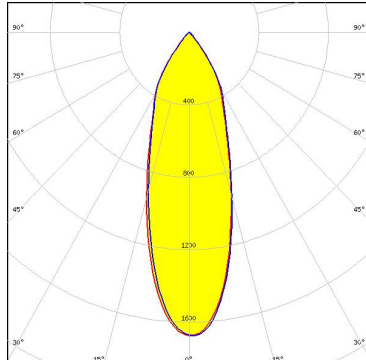
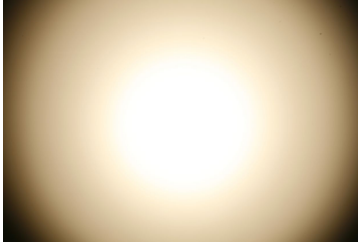
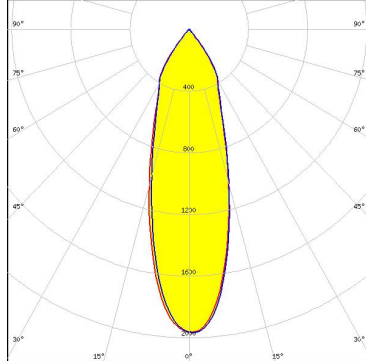
<p>LUMILEDS</p> <p>LED LUXEON CoB 1204HD FWHM 20.0° Efficiency 92 % Peak intensity 3.450 cd/lm LEDs/each optic 1 Light colour White Required components: C11981_LENINA-STD-BASE-COB-L110</p>		
<p>LUMILEDS</p> <p>LED LUXEON CoB 1205HD FWHM 23.0° Efficiency 92 % Peak intensity 3.000 cd/lm LEDs/each optic 1 Light colour White Required components: C11981_LENINA-STD-BASE-COB-L110</p>		
<p>LUMILEDS</p> <p>LED LUXEON CoB 1208 FWHM 33.0° Efficiency 83 % Peak intensity 1.700 cd/lm LEDs/each optic 1 Light colour White Required components: C12292_LENINA-STD-BASE-MEZ C12606_LENINA-DL</p>		
<p>LUMILEDS</p> <p>LED LUXEON CoB 1208 FWHM 31.0° Efficiency 88 % Peak intensity 2.000 cd/lm LEDs/each optic 1 Light colour White Required components: C12292_LENINA-STD-BASE-MEZ</p>		

PHOTOMETRIC DATA (MEASURED):



LED LUXEON CoB 1211
 FWHM 35.0°
 Efficiency 93 %
 Peak intensity 1.900 cd/lm
 LEDs/each optic 1
 Light colour White
 Required components:
 C13867_LENINA-STD-BASE-VERO29
 Bender Wirth: 431 Typ L3

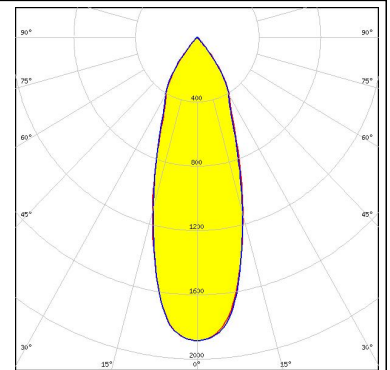
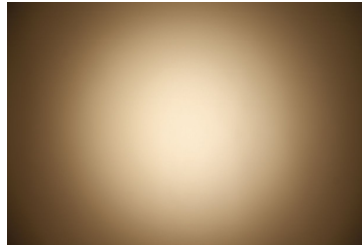

LED LUXEON CoB 1211
 FWHM 37.0°
 Efficiency 87 %
 Peak intensity 1.600 cd/lm
 LEDs/each optic 1
 Light colour White
 Required components:
 C13867_LENINA-STD-BASE-VERO29
 C12606_LENINA-DL
 Bender Wirth: 431 Typ L3

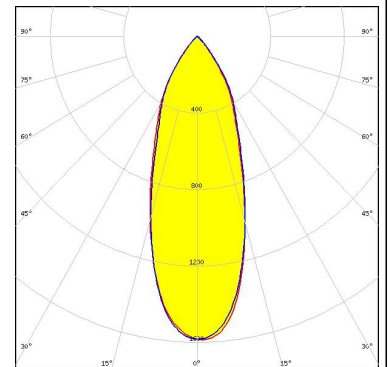
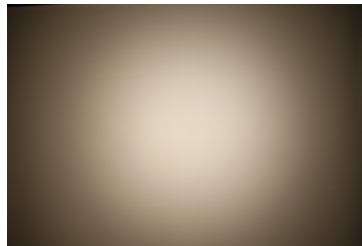



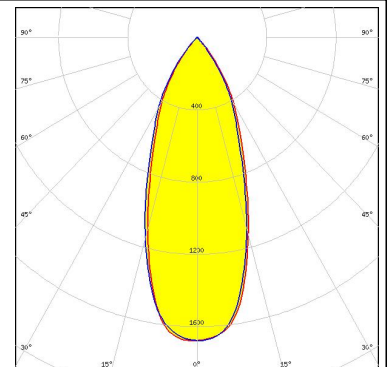

LED LUXEON CoB 1216/1812
 FWHM 39.0°
 Efficiency 92 %
 Peak intensity 1.700 cd/lm
 LEDs/each optic 1
 Light colour White
 Required components:
 C12692_LENINA-STD-BASE-CLL040

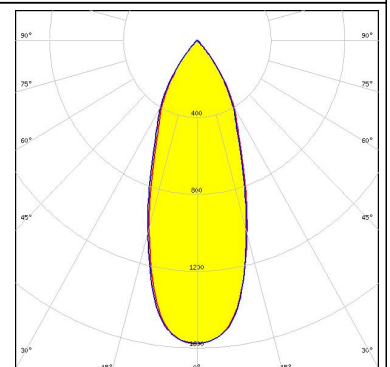
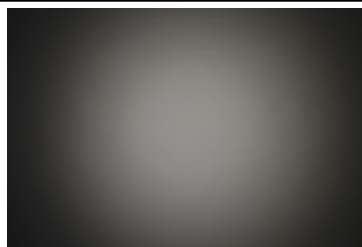

LED LUXEON CoB 1216/1812
 FWHM 38.0°
 Efficiency 85 %
 Peak intensity 1.580 cd/lm
 LEDs/each optic 1
 Light colour White
 Required components:
 A.A.G. STUCCHI: 8102/G2 + S-8000/12

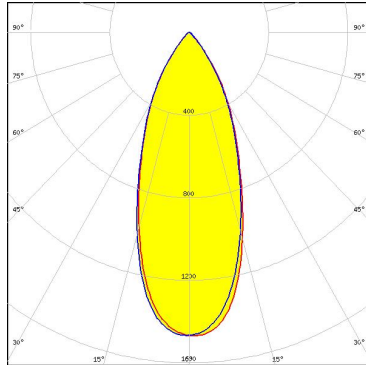
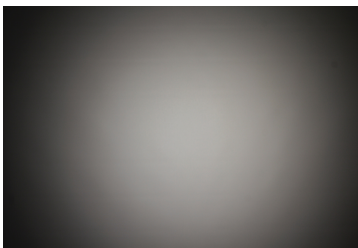
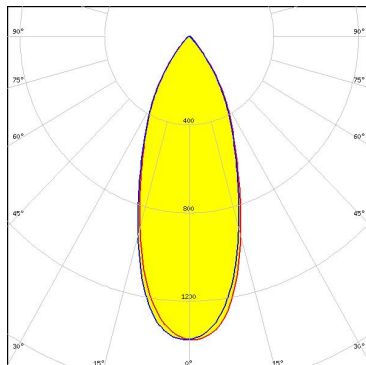

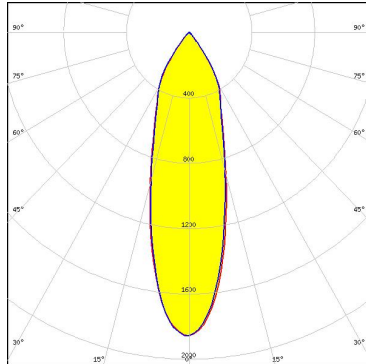
PHOTOMETRIC DATA (MEASURED):

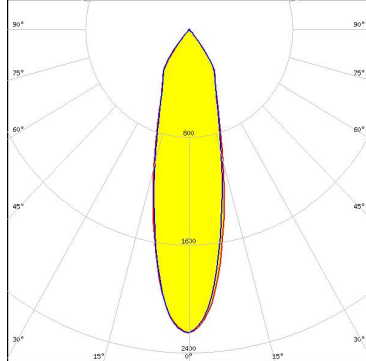
<p>LUMILEDS</p> <p>LED LUXEON CoB 1216/1812 FWHM 40.0° Efficiency 88 % Peak intensity 1.470 cd/lm LEDs/each optic 1 Light colour White Required components: C12692_LENINA-STD-BASE-CLL040 C12606_LENINA-DL</p>		
<p>LUMILEDS</p> <p>LED LUXEON CoB 1216/1812 FWHM 39.0° Efficiency 81 % Peak intensity 1.380 cd/lm LEDs/each optic 1 Light colour White Required components: C12606_LENINA-DL A.A.G. STUCCHI: 8102/G2 + S-8000/12</p>		
<p>LUMILEDS</p> <p>LED LUXEON K12 FWHM 30.0° Efficiency 83 % Peak intensity 1.900 cd/lm LEDs/each optic 1 Light colour White Required components: C12924_LENINA-STD-BASE-LUXEON-K C12606_LENINA-DL</p>		
<p>LUMILEDS</p> <p>LED LUXEON K12 FWHM 28.0° Efficiency 89 % Peak intensity 2.300 cd/lm LEDs/each optic 1 Light colour White Required components: C12924_LENINA-STD-BASE-LUXEON-K</p>		

PHOTOMETRIC DATA (MEASURED):

LUMILEDS

LED LUXEON K16
 FWHM 30.0°
 Efficiency 85 %
 Peak intensity 2.000 cd/m
 LEDs/each optic 1
 Light colour White
 Required components:
 C12924_LENASTD-BASE-LUXEON-K

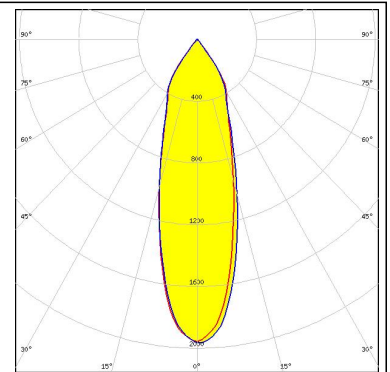

LUMILEDS

LED LUXEON K16
 FWHM 34.0°
 Efficiency 79 %
 Peak intensity 1.500 cd/m
 LEDs/each optic 1
 Light colour White
 Required components:
 C12924_LENASTD-BASE-LUXEON-K
 C12606_LENINA-DL

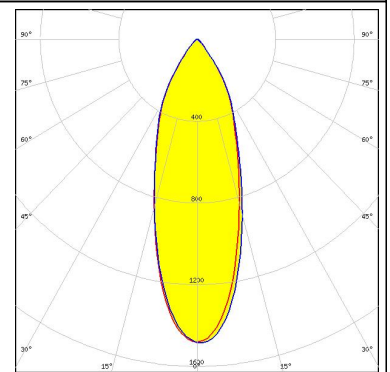
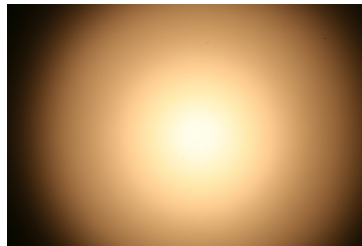

LUMINUS

LED CDM-14 (Dim-To-Warm)
 FWHM 31.0°
 Efficiency 88 %
 Peak intensity 1.900 cd/m
 LEDs/each optic 1
 Light colour White
 Required components:
 C13868_LENASTD-BASE-VERO13-18
 C12606_LENINA-DL
 Bender Wirth: 491 Typ L2

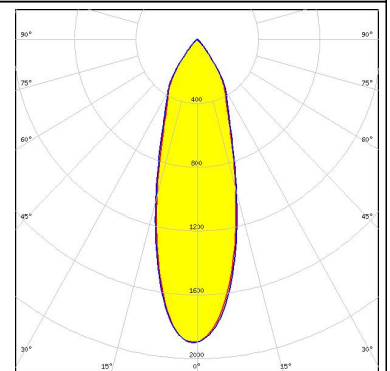
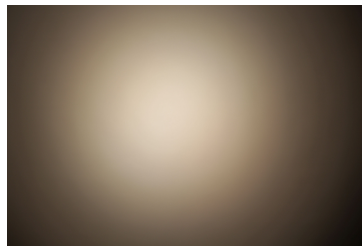



LUMINUS

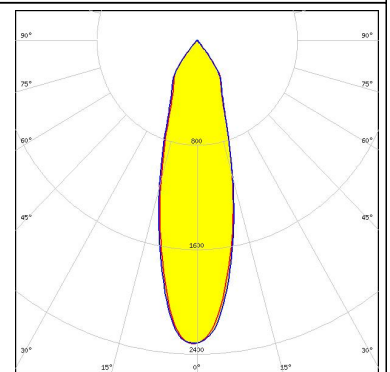
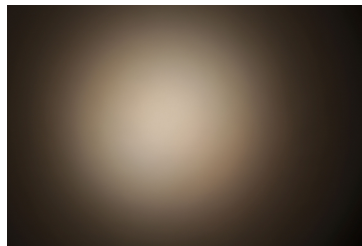

LED CDM-14 (Dim-To-Warm)
 FWHM 29.0°
 Efficiency 92 %
 Peak intensity 2.300 cd/m
 LEDs/each optic 1
 Light colour White
 Required components:
 C13868_LENASTD-BASE-VERO13-18
 Bender Wirth: 491 Typ L2

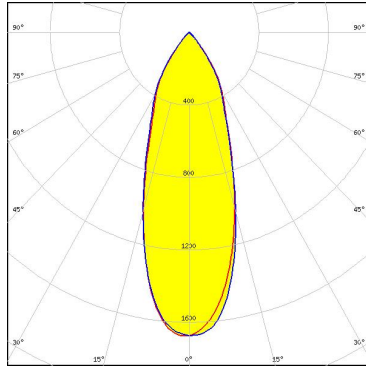
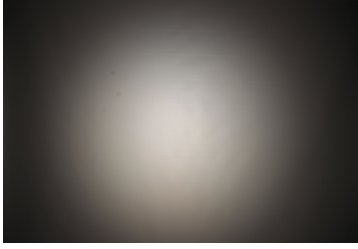
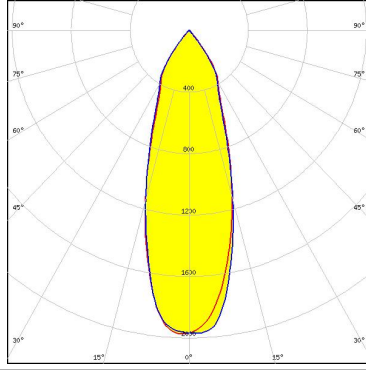
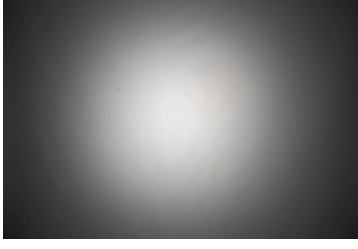
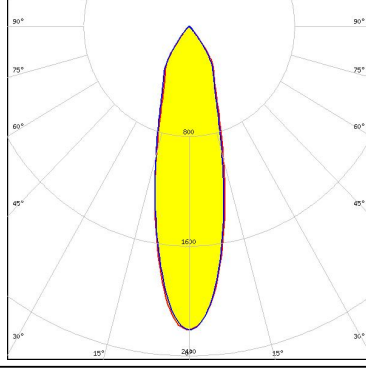

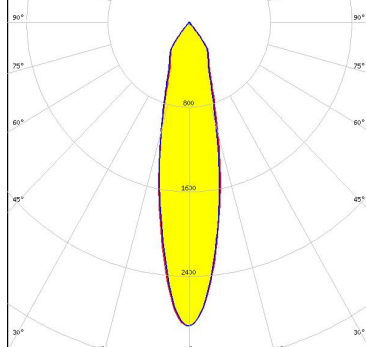
PHOTOMETRIC DATA (MEASURED):

<p>LUMINUS</p> <p>LED CDM-18 (Dim-To-Warm) FWHM 36.0° Efficiency 88 % Peak intensity 1.700 cd/lm LEDs/each optic 1 Light colour White</p> <p>Required components: C13868_LENINA-STD-BASE-VERO13-18 C12606_LENINA-DL Bender Wirth: 491 Typ L2</p>		
<p>LUMINUS</p> <p>LED CDM-18 (Dim-To-Warm) FWHM 34.0° Efficiency 92 % Peak intensity 1.980 cd/lm LEDs/each optic 1 Light colour White</p> <p>Required components: C13868_LENINA-STD-BASE-VERO13-18 Bender Wirth: 491 Typ L2</p>		
<p>LUMINUS</p> <p>LED CDM-9 (Dim-To-Warm) FWHM 27.0° Efficiency 87 % Peak intensity 2.200 cd/lm LEDs/each optic 1 Light colour White</p> <p>Required components: C13868_LENINA-STD-BASE-VERO13-18 C12606_LENINA-DL Bender Wirth: 490 Typ L1</p>		
<p>LUMINUS</p> <p>LED CDM-9 (Dim-To-Warm) FWHM 24.0° Efficiency 92 % Peak intensity 2.900 cd/lm LEDs/each optic 1 Light colour White</p> <p>Required components: C13868_LENINA-STD-BASE-VERO13-18 Bender Wirth: 490 Typ L1</p>		

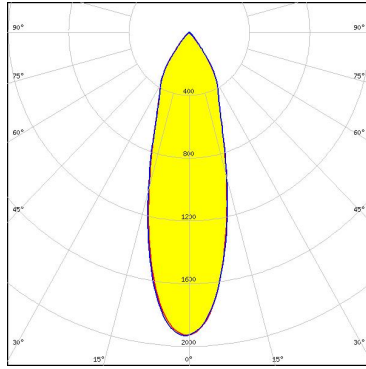
PHOTOMETRIC DATA (MEASURED):

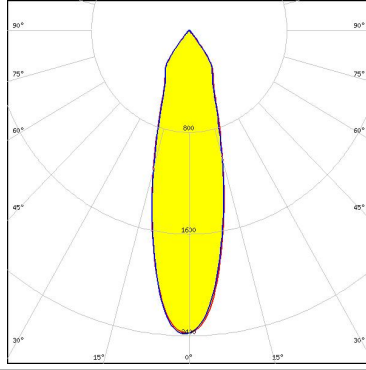
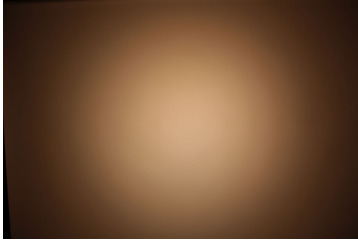
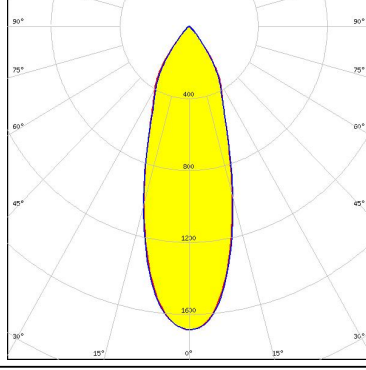
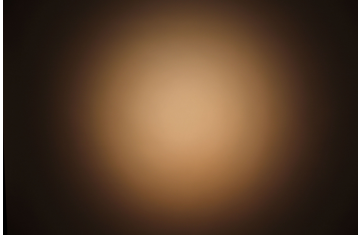
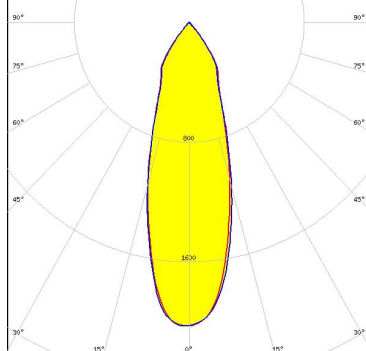
<p>LUMINUS</p> <p>LED CTM-14 (Tunable White) FWHM 31.0° Efficiency 87 % Peak intensity 1.900 cd/lm LEDs/each optic 1 Light colour White</p> <p>Required components: C13867_LENINA-STD-BASE-VERO29 C12606_LENINA-DL Bender Wirth: 442 Typ L3</p>		
<p>LUMINUS</p> <p>LED CTM-14 (Tunable White) FWHM 28.0° Efficiency 92 % Peak intensity 2.400 cd/lm LEDs/each optic 1 Light colour White</p> <p>Required components: C13867_LENINA-STD-BASE-VERO29 Bender Wirth: 442 Typ L3</p>		
<p>LUMINUS</p> <p>LED CTM-18 (Tunable White) FWHM 34.0° Efficiency 87 % Peak intensity 1.700 cd/lm LEDs/each optic 1 Light colour White</p> <p>Required components: C13867_LENINA-STD-BASE-VERO29 C12606_LENINA-DL Bender Wirth: 442 Typ L3</p>		
<p>LUMINUS</p> <p>LED CTM-18 (Tunable White) FWHM 32.0° Efficiency 92 % Peak intensity 2.000 cd/lm LEDs/each optic 1 Light colour White</p> <p>Required components: C13867_LENINA-STD-BASE-VERO29 Bender Wirth: 442 Typ L3</p>		

PHOTOMETRIC DATA (MEASURED):



LED CTM-22 (Tunable White)
 FWHM 40.0°
 Efficiency 87 %
 Peak intensity 1.400 cd/lm
 LEDs/each optic 1
 Light colour White
 Required components:
 C13867_LENINA-STD-BASE-VERO29
 C12606_LENINA-DL
 Bender Wirth: 494 Typ L3

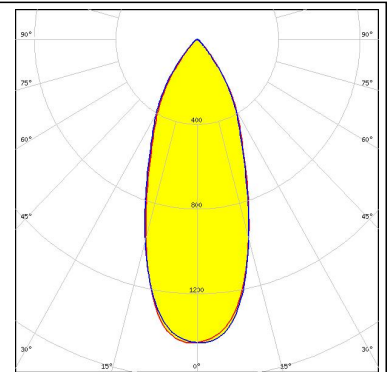
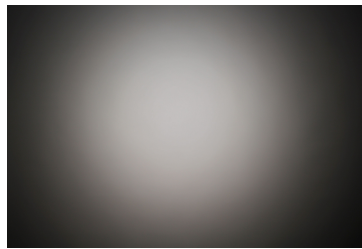

LED CTM-22 (Tunable White)
 FWHM 39.0°
 Efficiency 92 %
 Peak intensity 1.600 cd/lm
 LEDs/each optic 1
 Light colour White
 Required components:
 C13867_LENINA-STD-BASE-VERO29
 Bender Wirth: 494 Typ L3

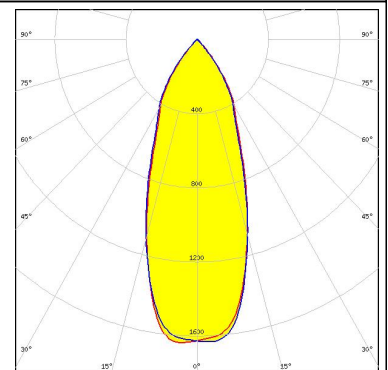
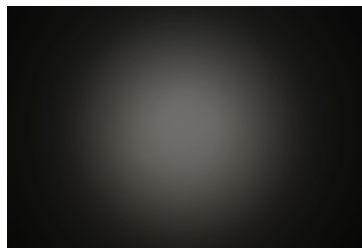

LED CxM-14 (19x19)
 FWHM 28.0°
 Efficiency 93 %
 Peak intensity 2.500 cd/lm
 LEDs/each optic 1
 Light colour White
 Required components:
 C12691_LENINA-STD-BASE-CLL030

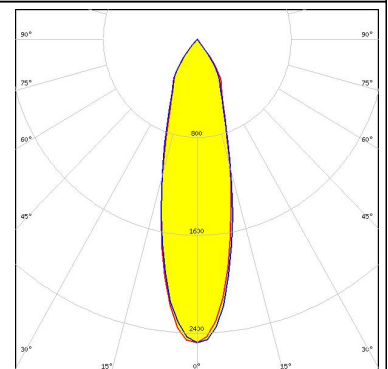
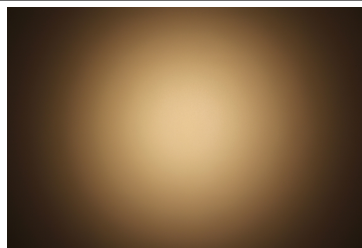

LED CxM-14 (19x19)
 FWHM 31.0°
 Efficiency 89 %
 Peak intensity 2.100 cd/lm
 LEDs/each optic 1
 Light colour White
 Required components:
 C12691_LENINA-STD-BASE-CLL030
 C12606_LENINA-DL

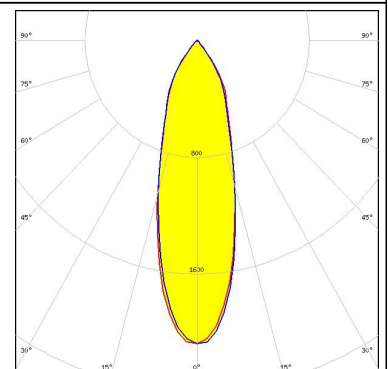
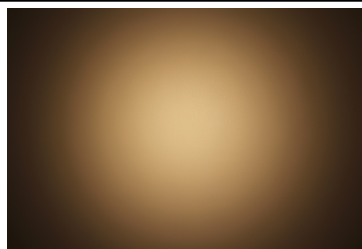

PHOTOMETRIC DATA (MEASURED):



LED CxM-22 (28x28)
FWHM 40.0°
Efficiency 89 %
Peak intensity 1.600 cd/lm
LEDs/each optic 1
Light colour White

Required components:
C12692_LENINA-STD-BASE-CLL040
C12606_LENINA-DL



LED CxM-22 (28x28)
FWHM 39.0°
Efficiency 92 %
Peak intensity 1.800 cd/lm
LEDs/each optic 1
Light colour White

Required components:
C12692_LENINA-STD-BASE-CLL040



LED COB J-Type
FWHM 32.0°
Efficiency 89 %
Peak intensity 1.900 cd/lm
LEDs/each optic 1
Light colour White

Required components:
C13868_LENINA-STD-BASE-VERO13-18
C12606_LENINA-DL

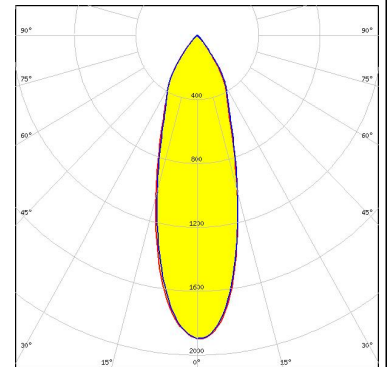
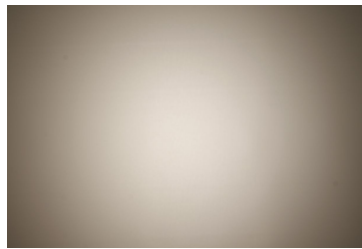

LED COB J-Type
FWHM 33.0°
Efficiency 81 %
Peak intensity 1.620 cd/lm
LEDs/each optic 1
Light colour White

Required components:
C12292_LENINA-STD-BASE-MEZ
C12606_LENINA-DL

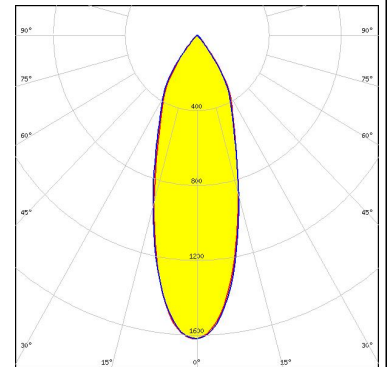
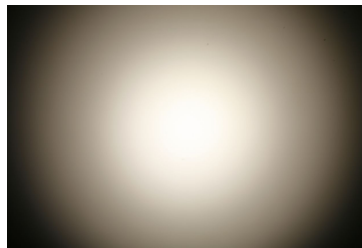

PHOTOMETRIC DATA (MEASURED):



LED COB J-Type
FWHM 29.0°
Efficiency 93 %
Peak intensity 2.300 cd/lm
LEDs/each optic 1
Light colour White
Required components:
 C13868_LENINA-STD-BASE-VERO13-18
 Bender Wirth: 463 Typ L2

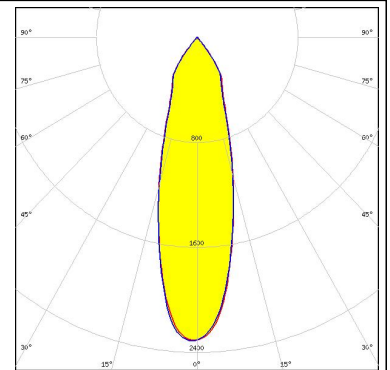
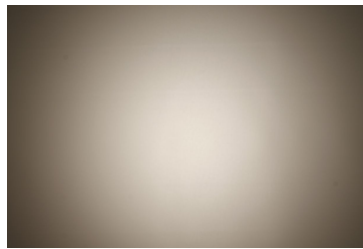

LED COB J-Type
FWHM 31.0°
Efficiency 86 %
Peak intensity 1.910 cd/lm
LEDs/each optic 1
Light colour White
Required components:
 C12292_LENINA-STD-BASE-MEZ

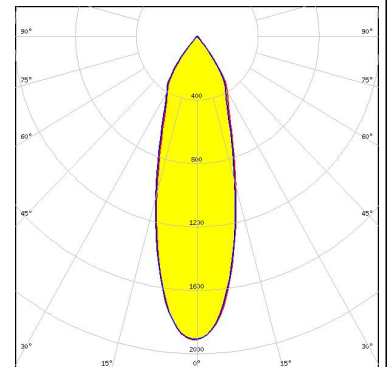
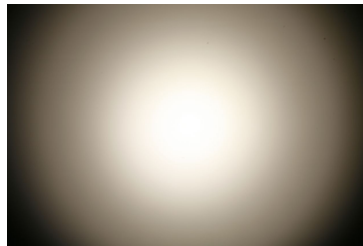

LED COB L-Type (LES 11)
FWHM 28.0°
Efficiency 87 %
Peak intensity 2.200 cd/lm
LEDs/each optic 1
Light colour White
Required components:
 C13868_LENINA-STD-BASE-VERO13-18
 C12606_LENINA-DL
 Bender Wirth: 438 Typ L1

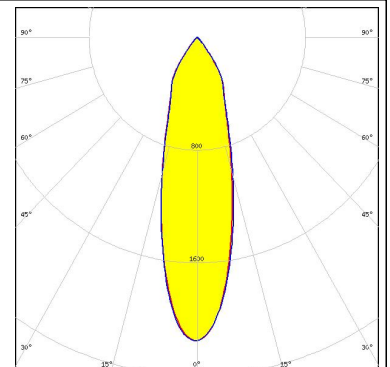
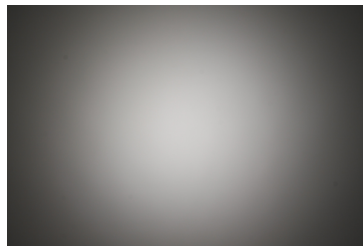

LED COB L-Type (LES 11)
FWHM 29.0°
Efficiency 79 %
Peak intensity 1.800 cd/lm
LEDs/each optic 1
Light colour White
Required components:
 C11981_LENINA-STD-BASE-COB-L110
 C12606_LENINA-DL

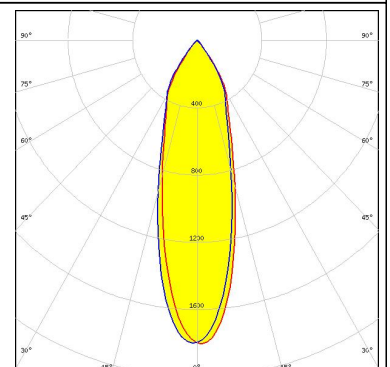
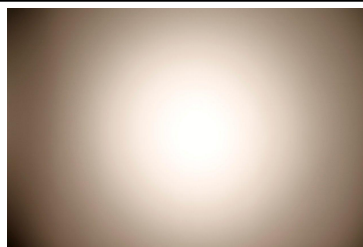

PHOTOMETRIC DATA (MEASURED):



LED COB L-Type (LES 11)
 FWHM 27.0°
 Efficiency 84 %
 Peak intensity 2.200 cd/lm
 LEDs/each optic 1
 Light colour White
 Required components:
 C11981_LENASTD-BASE-COB-L110

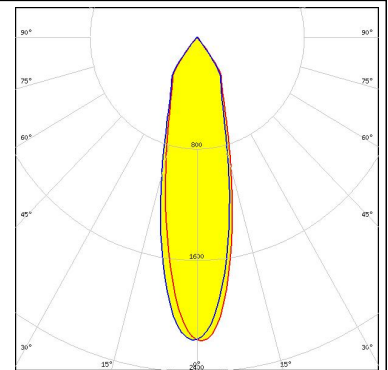
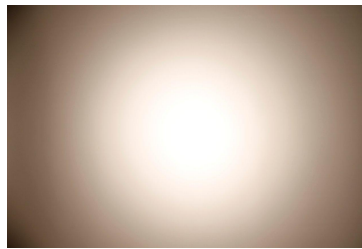

LED COB L-Type (LES 11)
 FWHM 25.0°
 Efficiency 91 %
 Peak intensity 2.700 cd/lm
 LEDs/each optic 1
 Light colour White
 Required components:
 C13868_LENASTD-BASE-VERO13-18
 Bender Wirth: 438 Typ L1

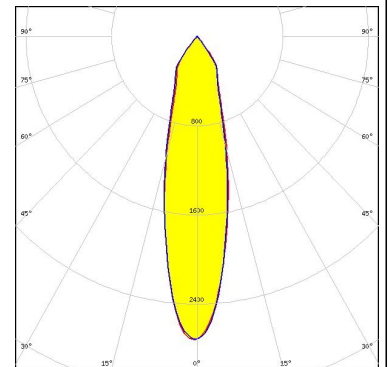



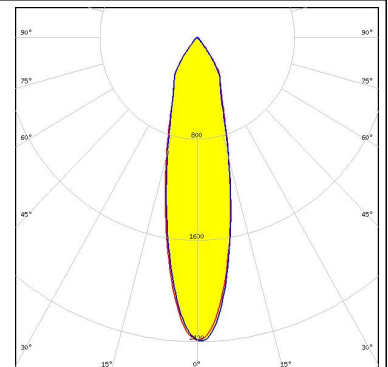
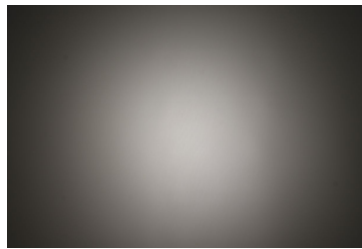

LED COB L-Type (LES 9)
 FWHM 26.0°
 Efficiency 89 %
 Peak intensity 2.400 cd/lm
 LEDs/each optic 1
 Light colour White
 Required components:
 C13868_LENASTD-BASE-VERO13-18
 C12606_LENINA-DL
 Bender Wirth: 438 Typ L1

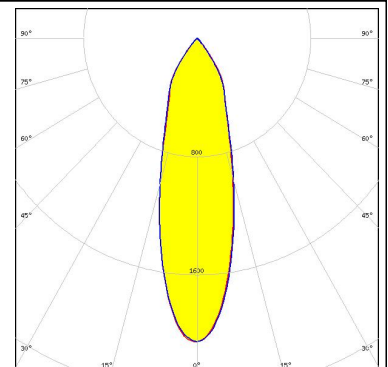
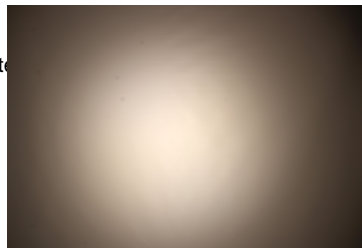

LED NVCWJ024Z-V1MT: COB J-Type Tunable White
 FWHM 29.0°
 Efficiency 87 %
 Peak intensity 2.000 cd/lm
 LEDs/each optic 1
 Light colour White
 Required components:
 C13868_LENASTD-BASE-VERO13-18
 C12606_LENINA-DL
 Bender Wirth: 498 Typ L2

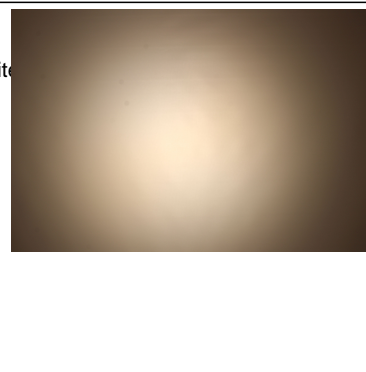
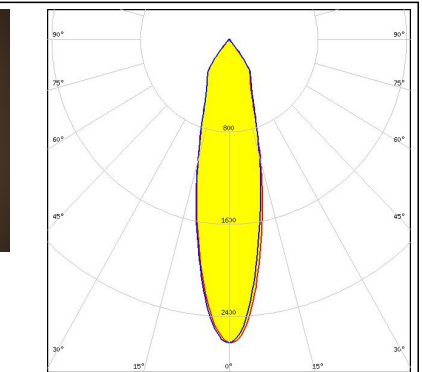

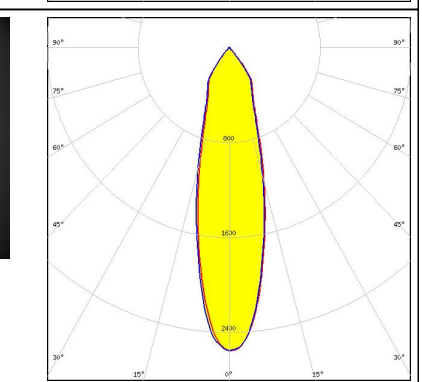
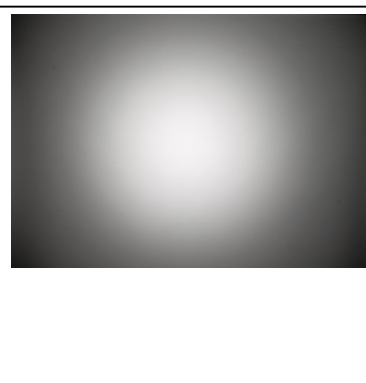
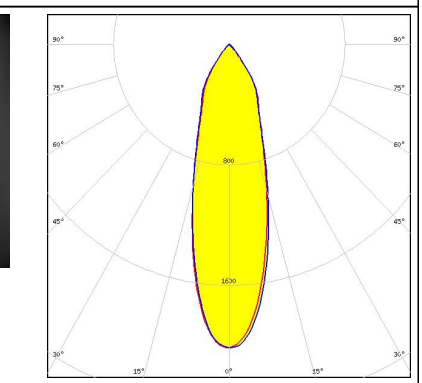
PHOTOMETRIC DATA (MEASURED):

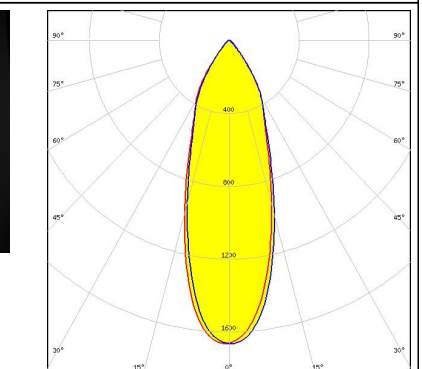
<p>NICHIA</p> <p>LED NVCWJ024Z-V1MT: COB J-Type Tunable White</p> <p>FWHM 26.0°</p> <p>Efficiency 92 %</p> <p>Peak intensity 2.600 cd/lm</p> <p>LEDs/each optic 1</p> <p>Light colour White</p> <p>Required components: C13868_LENINA-STD-BASE-VERO13-18 Bender Wirth: 498 Typ L2</p>		
<p>OSRAM Opto Semiconductors</p> <p>LED Soleriq S13</p> <p>FWHM 27.0°</p> <p>Efficiency 91 %</p> <p>Peak intensity 2.600 cd/lm</p> <p>LEDs/each optic 1</p> <p>Light colour White</p> <p>Required components: C13868_LENINA-STD-BASE-VERO13-18 Bender Wirth: 437 Typ L1</p>		
<p>OSRAM Opto Semiconductors</p> <p>LED Soleriq S13</p> <p>FWHM 30.0°</p> <p>Efficiency 87 %</p> <p>Peak intensity 2.000 cd/lm</p> <p>LEDs/each optic 1</p> <p>Light colour White</p> <p>Required components: C13868_LENINA-STD-BASE-VERO13-18 C12606_LENINA-DL Bender Wirth: 437 Typ L1</p>		
<p>OSRAM Opto Semiconductors</p> <p>LED Soleriq S19</p> <p>FWHM 34.0°</p> <p>Efficiency 89 %</p> <p>Peak intensity 1.700 cd/lm</p> <p>LEDs/each optic 1</p> <p>Light colour White</p> <p>Required components: C13867_LENINA-STD-BASE-VERO29 C12606_LENINA-DL Bender Wirth: 462 Typ L3</p>		

PHOTOMETRIC DATA (MEASURED):

OSRAM
Opto Semiconductors

LED Soleriq S19
 FWHM 32.0°
 Efficiency 93 %
 Peak intensity 2.000 cd/lm
 LEDs/each optic 1
 Light colour White
 Required components:
 C13867_LENINA-STD-BASE-VERO29
 Bender Wirth: 462 Typ L3

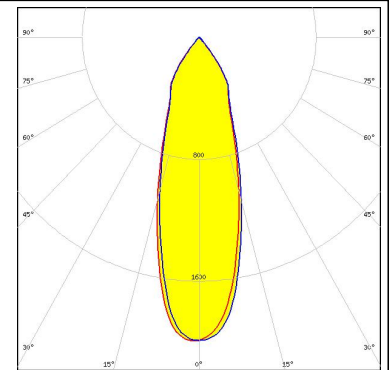
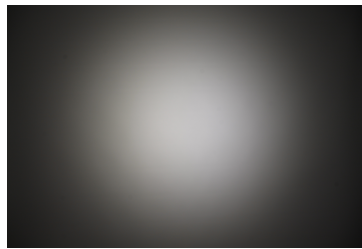

PHILIPS

LED Fortimo SLM L13 CoB
 FWHM 30.0°
 Efficiency 86 %
 Peak intensity 2.000 cd/lm
 LEDs/each optic 1
 Light colour White
 Required components:
 C12292_LENINA-STD-BASE-MEZ
 C12606_LENINA-DL

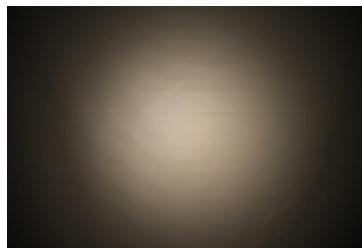

PHILIPS

LED Fortimo SLM L13 CoB
 FWHM 27.0°
 Efficiency 93 %
 Peak intensity 2.600 cd/lm
 LEDs/each optic 1
 Light colour White
 Required components:
 C12292_LENINA-STD-BASE-MEZ

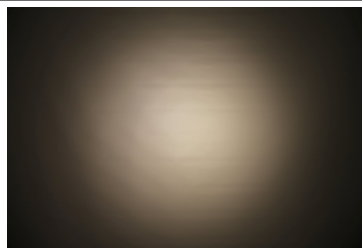

PHILIPS

LED Fortimo SLM L15 CoB
 FWHM 29.0°
 Efficiency %
 Peak intensity 2.300 cd/lm
 LEDs/each optic 1
 Light colour White
 Required components:
 C12292_LENINA-STD-BASE-MEZ

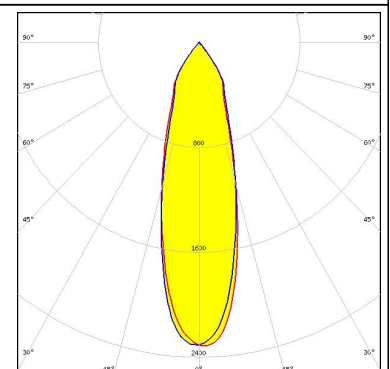
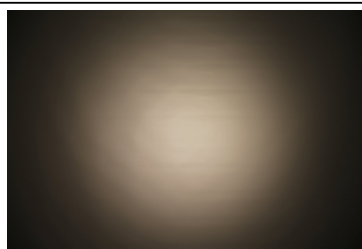

PHOTOMETRIC DATA (MEASURED):

PHILIPS

LED Fortimo SLM L15 CoB
 FWHM 32.0°
 Efficiency 86 %
 Peak intensity 1.800 cd/lm
 LEDs/each optic 1
 Light colour White
 Required components:
 C12292_LENINA-STD-BASE-MEZ
 C12606_LENINA-DL

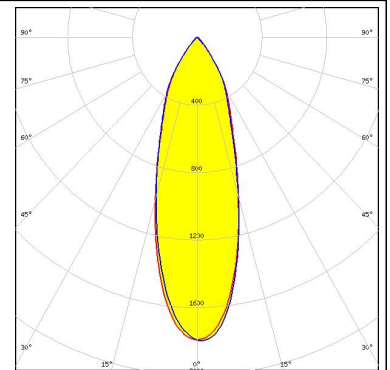

PHILIPS

LED Fortimo SLM L19 CoB
 FWHM 33.0°
 Efficiency 92 %
 Peak intensity 2.000 cd/lm
 LEDs/each optic 1
 Light colour White
 Required components:
 C12692_LENINA-STD-BASE-CLL040

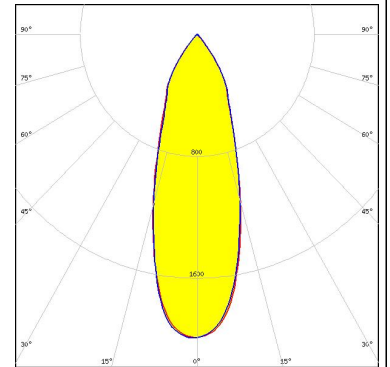
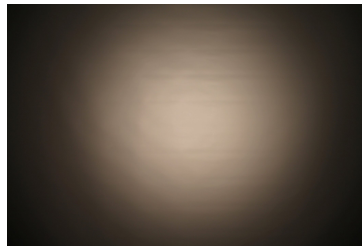

PHILIPS

LED Fortimo SLM L19 CoB
 FWHM 35.0°
 Efficiency 86 %
 Peak intensity 1.600 cd/lm
 LEDs/each optic 1
 Light colour White
 Required components:
 C12692_LENINA-STD-BASE-CLL040
 C12606_LENINA-DL

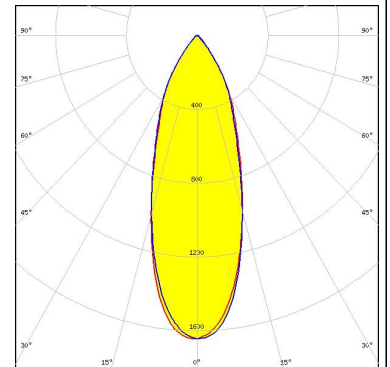
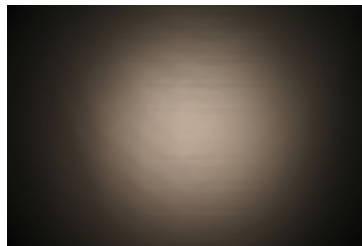

PHILIPS

LED Fortimo SLM L23 CoB
 FWHM 39.0°
 Efficiency 92 %
 Peak intensity 1.700 cd/lm
 LEDs/each optic 1
 Light colour White
 Required components:
 C12692_LENINA-STD-BASE-CLL040

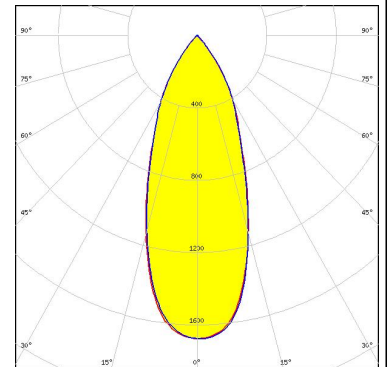
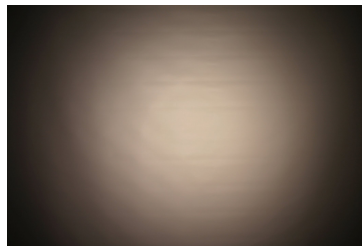

PHOTOMETRIC DATA (MEASURED):

PHILIPS

LED Fortimo SLM L23 CoB
 FWHM 40.0°
 Efficiency 86 %
 Peak intensity 1.400 cd/lm
 LEDs/each optic 1
 Light colour White
 Required components:
 C12692_LENINA-STD-BASE-CLL040
 C12606_LENINA-DL

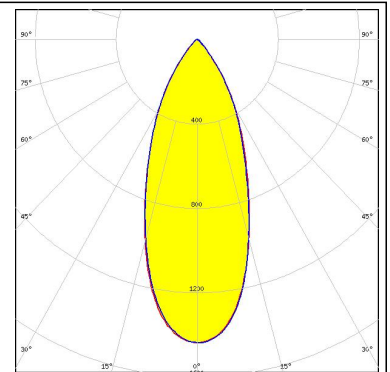
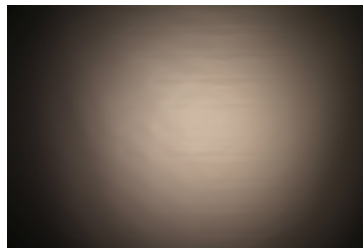

SAMSUNG

LED COB D Series LES 14.5 mm
 FWHM 33.0°
 Efficiency 87 %
 Peak intensity 1.800 cd/lm
 LEDs/each optic 1
 Light colour White
 Required components:
 C12691_LENINA-STD-BASE-CLL030
 C12606_LENINA-DL

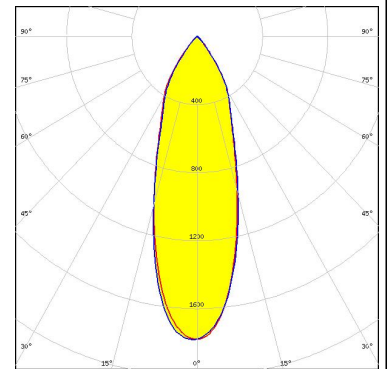
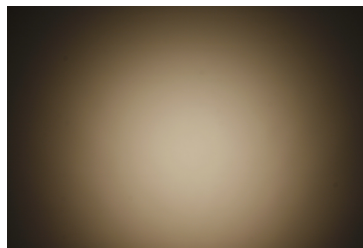

SAMSUNG

LED COB D Series LES 14.5 mm
 FWHM 30.0°
 Efficiency 92 %
 Peak intensity 2.200 cd/lm
 LEDs/each optic 1
 Light colour White
 Required components:
 C12691_LENINA-STD-BASE-CLL030

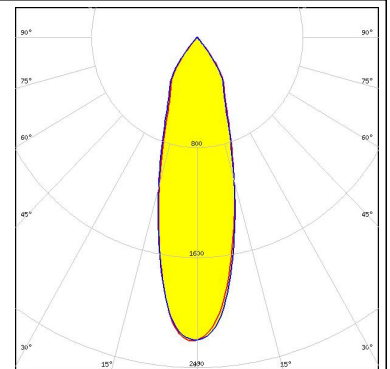
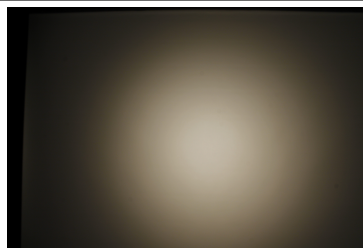

SAMSUNG

LED COB D Series LES 22 mm
 FWHM 40.0°
 Efficiency 91 %
 Peak intensity 1.600 cd/lm
 LEDs/each optic 1
 Light colour White
 Required components:
 C12692_LENINA-STD-BASE-CLL040

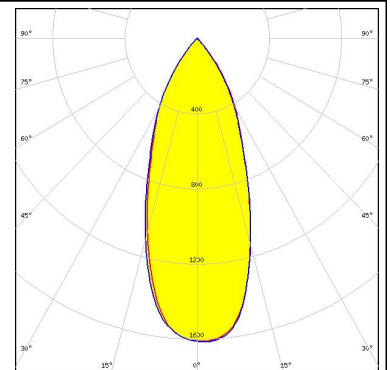
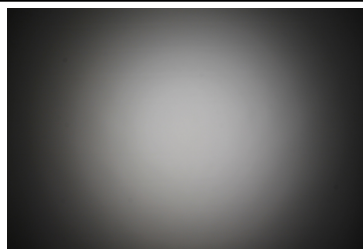

PHOTOMETRIC DATA (MEASURED):

SAMSUNG

LED COB D Series LES 22 mm
 FWHM 41.0°
 Efficiency 87 %
 Peak intensity 1.400 cd/lm
 LEDs/each optic 1
 Light colour White
 Required components:
 C12692_LENINA-STD-BASE-CLL040
 C12606_LENINA-DL

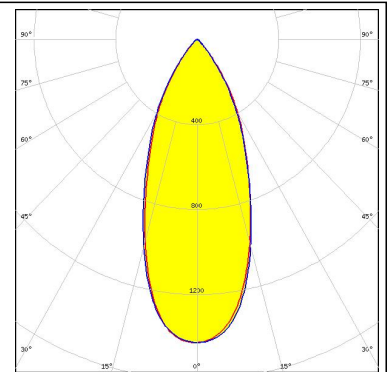
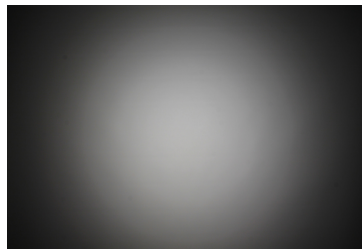

SAMSUNG

LED LC026B / 033B / 040B
 FWHM 33.0°
 Efficiency 92 %
 Peak intensity 2.000 cd/lm
 LEDs/each optic 1
 Light colour White
 Required components:
 C13868_LENINA-STD-BASE-VERO13-18
 Bender Wirth: 450 Typ L2

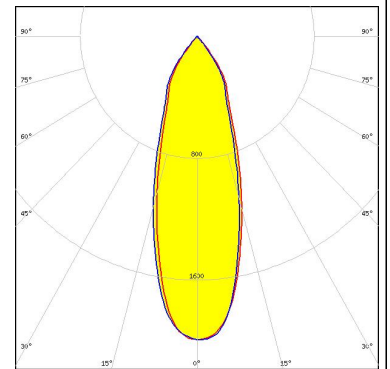
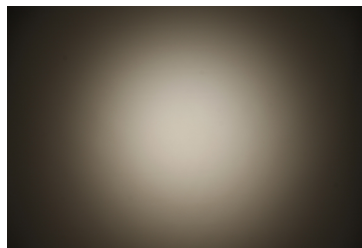

SAMSUNG

LED LC026B / 033B / 040B
 FWHM 35.0°
 Efficiency 88 %
 Peak intensity 1.700 cd/lm
 LEDs/each optic 1
 Light colour White
 Required components:
 C13868_LENINA-STD-BASE-VERO13-18
 C12606_LENINA-DL
 Bender Wirth: 450 Typ L2

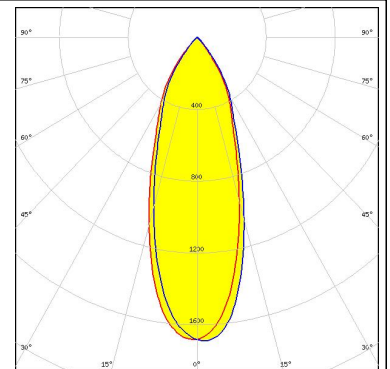
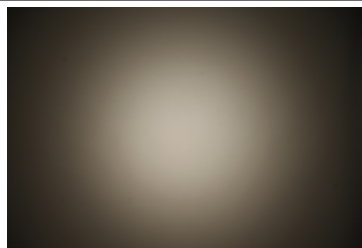

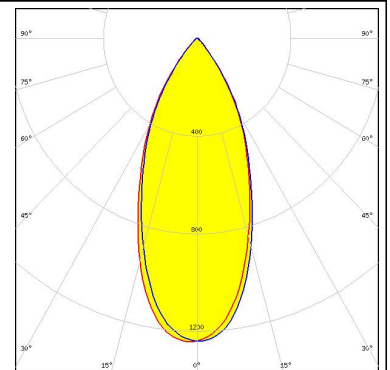
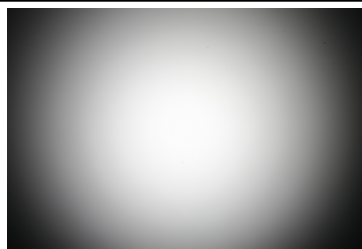

SEOUL SEMICONDUCTOR

LED ZC25/40/60
 FWHM 44.0°
 Efficiency 81 %
 Peak intensity 1.200 cd/lm
 LEDs/each optic 1
 Light colour White
 Required components:
 C12692_LENINA-STD-BASE-CLL040
 C12606_LENINA-DL



PHOTOMETRIC DATA (MEASURED):

			
SEoul SEMICONDUCTOR			
LED	ZC25/40/60		
FWHM	42.0°		
Efficiency	85 %		
Peak intensity	1.400 cd/lm		
LEDs/each optic	1		
Light colour	White		
Required components:			
	C12692_LENINA-STD-BASE-CLL040		

SHARP

LED	Mega Zenigata (GW5DGC)
FWHM	21.0°
Efficiency	86 %
Peak intensity	cd/lm
LEDs/each optic	1
Light colour	White
Required components:	
	C12292_LENINA-STD-BASE-MEZ

SHARP

LED	Mega Zenigata (GW5DGC)
FWHM	22.0°
Efficiency	78 %
Peak intensity	cd/lm
LEDs/each optic	1
Light colour	White
Required components:	
	C12292_LENINA-STD-BASE-MEZ
	C12606_LENINA-DL

SHARP

LED	Mega Zenigata (GW6DME)
FWHM	30.0°
Efficiency	87 %
Peak intensity	2.000 cd/lm
LEDs/each optic	1
Light colour	White
Required components:	
	C12292_LENINA-STD-BASE-MEZ

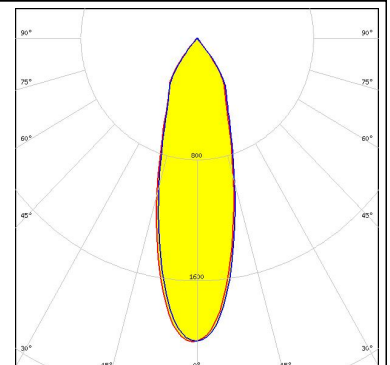
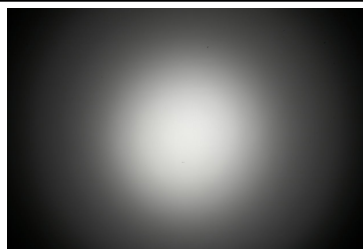

PHOTOMETRIC DATA (MEASURED):

SHARP

LED Mega Zenigata (GW6DME)
 FWHM 32.0°
 Efficiency 82 %
 Peak intensity 1.690 cd/lm
 LEDs/each optic 1
 Light colour White
 Required components:
 C12292_LENINA-STD-BASE-MEZ
 C12606_LENINA-DL

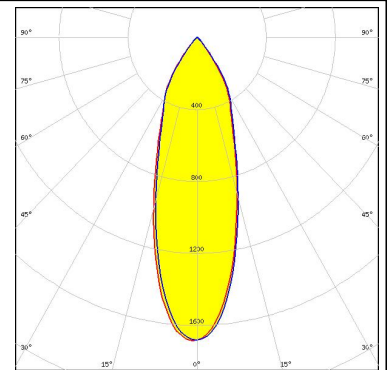

TRIDONIC

LED SLE G7 LES15
 FWHM 30.0°
 Efficiency 93 %
 Peak intensity 2.300 cd/lm
 LEDs/each optic 1
 Light colour White
 Required components:
 C12691_LENINA-STD-BASE-CLL030

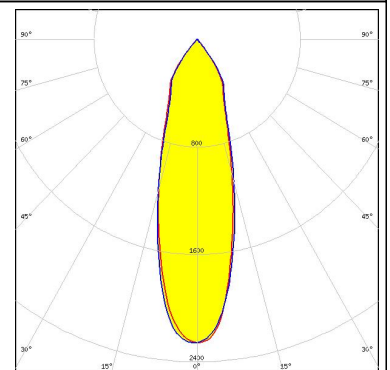
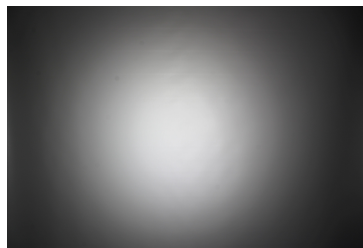

TRIDONIC

LED SLE G7 LES17 H
 FWHM 31.0°
 Efficiency 91 %
 Peak intensity 2.100 cd/lm
 LEDs/each optic 1
 Light colour White
 Required components:
 C14547_LENINA-ADAPTER-B

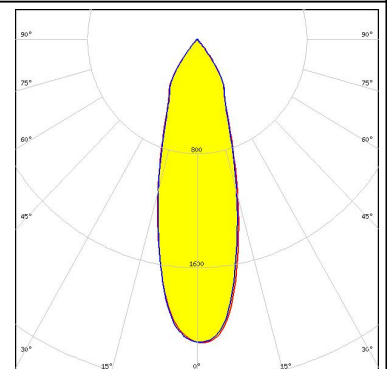
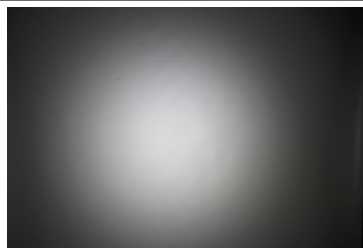

TRIDONIC

LED SLE G7 LES21 H
 FWHM 37.0°
 Efficiency 91 %
 Peak intensity 1.700 cd/lm
 LEDs/each optic 1
 Light colour White
 Required components:
 C14547_LENINA-ADAPTER-B

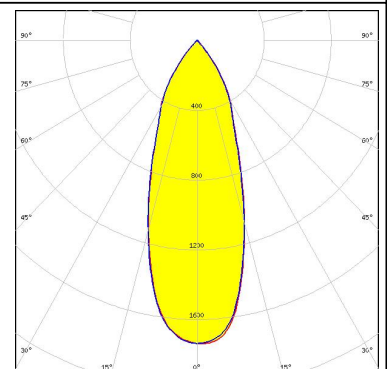
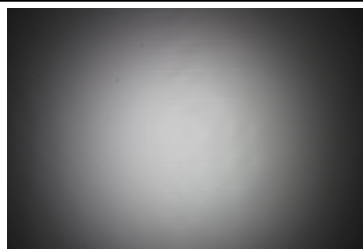

PHOTOMETRIC DATA (MEASURED):

XICATO

LED XOB 14.5 mm
FWHM 29.0°
Efficiency 93 %
Peak intensity 2.297 cd/lm
LEDs/each optic 1
Light colour White
Required components:
C12691_LENINA-STD-BASE-CLL030

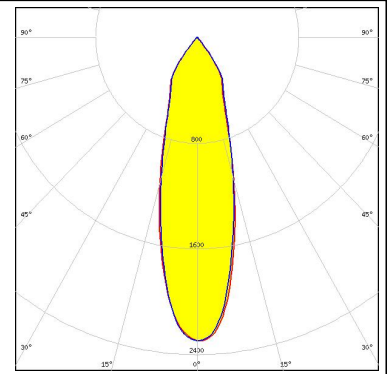

PHOTOMETRIC DATA (SIMULATED):

<p>bridgelux.</p> <p>LED V10 Gen7 FWHM 26.0° Efficiency 91 % Peak intensity 2.730 cd/lm LEDs/each optic 1 Light colour White Required components: C13868_LENINA-STD-BASE-VERO13-18 Bender Wirth: 486 Typ L1</p>	
<p>bridgelux.</p> <p>LED V10 Gen7 FWHM 28.0° Efficiency 86 % Peak intensity 2.280 cd/lm LEDs/each optic 1 Light colour White Required components: C13868_LENINA-STD-BASE-VERO13-18 C12606_LENINA-DL Bender Wirth: 486 Typ L1</p>	
<p>bridgelux.</p> <p>LED V13 Gen7 FWHM 31.0° Efficiency 90 % Peak intensity 2.250 cd/lm LEDs/each optic 1 Light colour White Required components: C13868_LENINA-STD-BASE-VERO13-18 Bender Wirth: 477 Typ L1</p>	
<p>bridgelux.</p> <p>LED V13 Gen7 FWHM 26.0° Efficiency 87 % Peak intensity 2.230 cd/lm LEDs/each optic 1 Light colour White Required components: C12606_LENINA-DL IDEAL: 50-2103CT + 50-2100AN</p>	

PHOTOMETRIC DATA (SIMULATED):

<p>bridgelux.</p> <p>LED V13 Gen7 FWHM 32.0° Efficiency 86 % Peak intensity 2.000 cd/lm LEDs/each optic 1 Light colour White Required components: C13868_LENINA-STD-BASE-VERO13-18 C12606_LENINA-DL Bender Wirth: 477 Typ L1</p>	
<p>bridgelux.</p> <p>LED V13 Gen7 FWHM 26.0° Efficiency 90 % Peak intensity 2.647 cd/lm LEDs/each optic 1 Light colour White Required components: IDEAL: 50-2103CT + 50-2100AN</p>	
<p>bridgelux.</p> <p>LED V22 Gen7 FWHM 42.0° Efficiency 87 % Peak intensity 1.450 cd/lm LEDs/each optic 1 Light colour White Required components: C13867_LENINA-STD-BASE-VERO29 C12606_LENINA-DL Bender Wirth: 431 Typ L3</p>	
<p>bridgelux.</p> <p>LED V22 Gen7 FWHM 42.0° Efficiency 90 % Peak intensity 1.537 cd/lm LEDs/each optic 1 Light colour White Required components: C13867_LENINA-STD-BASE-VERO29 Bender Wirth: 431 Typ L3</p>	

PHOTOMETRIC DATA (SIMULATED):



LED CXA/B 30xx
FWHM 30.0°
Efficiency 84 %
Peak intensity 2.000 cd/lm
LEDs/each optic 1
Light colour White
Required components:
C12606_LENINA-DL
IDEAL: 50-2234C + 50-2100LN

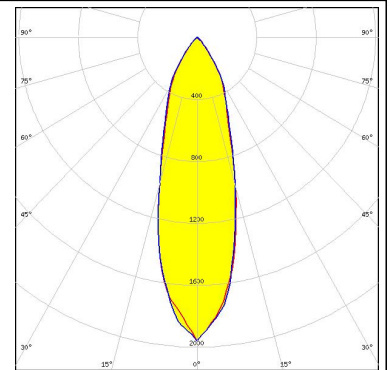

LED CXA/B 30xx
FWHM 28.0°
Efficiency 89 %
Peak intensity 2.400 cd/lm
LEDs/each optic 1
Light colour White
Required components:
IDEAL: 50-2234C + 50-2100LN

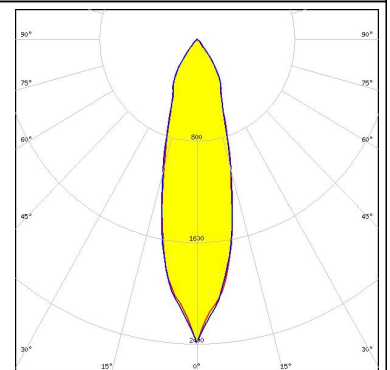

LED CxM-14 (19x19)
FWHM 29.0°
Efficiency 91 %
Peak intensity 2.300 cd/lm
LEDs/each optic 1
Light colour White
Required components:
C13868_LENINA-STD-BASE-VERO13-18
Bender Wirth: 433 Typ L1



LED CxM-14 (19x19)
FWHM 31.0°
Efficiency 88 %
Peak intensity 2.000 cd/lm
LEDs/each optic 1
Light colour White
Required components:
C13868_LENINA-STD-BASE-VERO13-18
C12606_LENINA-DL
Bender Wirth: 433 Typ L1

PHOTOMETRIC DATA (SIMULATED):



LED CxM-9 (13.5x13.5)
FWHM 26.0°
Efficiency 87 %
Peak intensity 2.300 cd/lm
LEDs/each optic 1
Light colour White
Required components:
C13868_LENINA-STD-BASE-VERO13-18
C12606_LENINA-DL
Bender Wirth: 434 Typ L1



LED CxM-9 (13.5x13.5)
FWHM 23.0°
Efficiency 91 %
Peak intensity 3.000 cd/lm
LEDs/each optic 1
Light colour White
Required components:
C13868_LENINA-STD-BASE-VERO13-18
Bender Wirth: 434 Typ L1



Opto Semiconductors



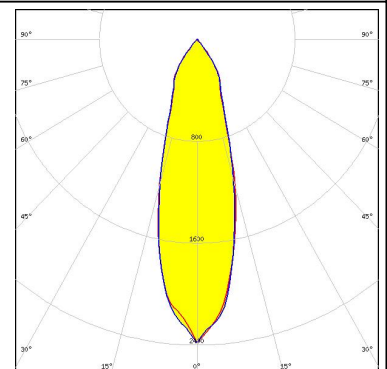

LED Soleriq S15
FWHM 30.0°
Efficiency 90 %
Peak intensity 2.380 cd/lm
LEDs/each optic 1
Light colour White
Required components:
C12691_LENINA-STD-BASE-CLL030

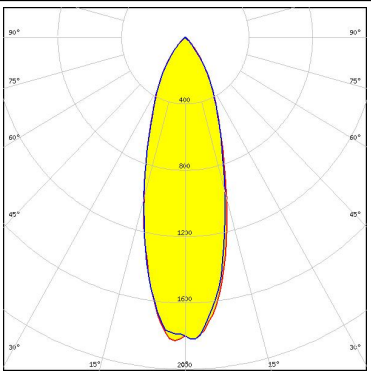

SEOUL SEMICONDUCTOR

LED ZC12/18
FWHM 31.0°
Efficiency 88 %
Peak intensity 2.000 cd/lm
LEDs/each optic 1
Light colour White
Required components:
C13868_LENINA-STD-BASE-VERO13-18
C12606_LENINA-DL
Bender Wirth: 433 Typ L1

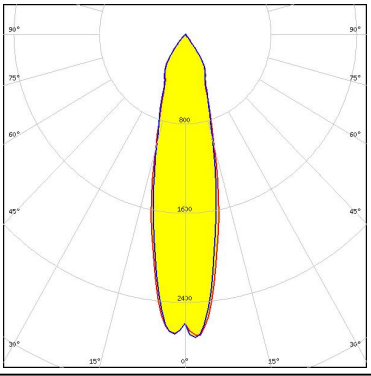
PHOTOMETRIC DATA (SIMULATED):

<p> SEUL SEMICONDUCTOR</p> <p>LED ZC12/18 FWHM 32.0° Efficiency 84 % Peak intensity 1.800 cd/lm LEDs/each optic 1 Light colour White Required components: C12691_LENINA-STD-BASE-CLL030 C12606_LENINA-DL</p>	
<p> SEUL SEMICONDUCTOR</p> <p>LED ZC12/18 FWHM 26.0° Efficiency 89 % Peak intensity 2.700 cd/lm LEDs/each optic 1 Light colour White Required components: C12691_LENINA-STD-BASE-CLL030</p>	
<p> SEUL SEMICONDUCTOR</p> <p>LED ZC12/18 FWHM 29.0° Efficiency 91 % Peak intensity 2.300 cd/lm LEDs/each optic 1 Light colour White Required components: C13868_LENINA-STD-BASE-VERO13-18 Bender Wirth: 433 Typ L1</p>	
<p> SEUL SEMICONDUCTOR</p> <p>LED ZC4/6 FWHM 23.0° Efficiency 91 % Peak intensity 3.000 cd/lm LEDs/each optic 1 Light colour White Required components: C13868_LENINA-STD-BASE-VERO13-18 Bender Wirth: 434 Typ L1</p>	

PHOTOMETRIC DATA (SIMULATED):

	
SEOUL SEMICONDUCTOR	
LED	ZC4/6
FWHM	26.0°
Efficiency	87 %
Peak intensity	2.300 cd/m
LEDs/each optic	1
Light colour	White
Required components:	
C13868_LENINA-STD-BASE-VERO13-18	
C12606_LENINA-DL	
Bender Wirth: 434 Typ L1	

GENERAL INFORMATION:

NOTE: The typical beam angle will be changed by different color, chip size and chip position tolerance. The typical total beam angle is the full angle measured where the luminous intensity is half of the peak value.

Due to use of high power COB's with this product, special attention to proper thermal design is highly recommended. LEDiL has no liability for direct, indirect or consecutive damages arising from the LEDiL products being used outside of the recommended temperature range.

MATERIALS:

As part of our continuous research and improvement processes, and to ensure the best possible quality and availability of our products, LEDiL reserves the right to change material grades without notice.

PRODUCT DATA USER AGREEMENT AND DISCLAIMER:

The measured data in the provided downloadable LEDiL Product Datasheets and Mechanical 2D-Drawings is rounded and provided as reference for planning. LEDiL Oy's optical specifications have been verified by conducting performance testing of the products in accordance with the company's quality system. The reported data are averaged results of multiple measurements with typical variation. LEDiL Oy reserves the right to without prior notification make changes and improvements to its products.

LEDiL Oy assumes neither warranty, nor guarantee nor any other liability of any kind for the contents and correctness of the provided data. The provided data has been generated with highest diligence but the provided data may in reality not represent the complete possible variation range of all intrinsic parameters. Therefore, in certain cases a deviation from the provided data could occur.

LEDiL Oy reserves the right to undertake technical changes of its products without further notification which could lead to changes in the provided data. LEDiL Oy assumes no liability of any kind for the possible deviation from any provided data or any other damage resulting from the usage of the provided data.

The user agrees to this disclaimer and user agreement with the download or usage of the provided files.

LEDiL Oy

Joensuunkatu 13
FI-24240 SALO
Finland

LEDiL Inc.

228 West Page Street
Suite D
Sycamore IL 60178
USA

Local sales and technical support

[www.ledil.com/
where_to_buy](http://www.ledil.com/where_to_buy)

Shipping locations

Salo, Finland
Hong Kong, China

Distribution Partners

[www.ledil.com/
where_to_buy](http://www.ledil.com/where_to_buy)