

FEATURES

- 2.1 Ω on resistance**
- 0.5 Ω maximum on resistance flatness**
- Up to 250 mA continuous current**
- Fully specified at $+12$ V, ± 15 V, ± 5 V**
- No V_L supply required**
- 3 V logic-compatible inputs**
- Rail-to-rail operation**
- 10-lead MSOP and 10-lead, 3 mm \times 3 mm LFCSP packages**

APPLICATIONS

- Automatic test equipment**
- Data acquisition systems**
- Relay replacements**
- Battery-powered systems**
- Sample-and-hold systems**
- Audio signal routing**
- Video signal routing**
- Communication systems**

GENERAL DESCRIPTION

The [ADG1421/ADG1422/ADG1423](#) contain two independent single-pole/single-throw (SPST) switches. The [ADG1421](#) and [ADG1422](#) differ only in that the digital control logic is inverted. The [ADG1421](#) switches are turned on with Logic 1 on the appropriate control input, and Logic 0 is required for the [ADG1422](#). The [ADG1423](#) has one switch with digital control logic similar to that of the [ADG1421](#); the logic is inverted on the other switch. The [ADG1423](#) exhibits break-before-make switching action for use in multiplexer applications. Each switch conducts equally well in both directions when on and has an input signal range that extends to the supplies. In the off condition, signal levels up to the supplies are blocked.

The iCMOS[®] (industrial CMOS) modular manufacturing process combines high voltage, complementary metal-oxide semiconductor (CMOS) and bipolar technologies. It enables the development of a wide range of high performance analog ICs capable of 33 V operation in a footprint that no other generation of high voltage parts has achieved. Unlike analog ICs using conventional CMOS processes, iCMOS components can tolerate high supply voltages while providing increased performance, dramatically lower power consumption, and reduced package size.

Rev. A

[Document Feedback](#)

Information furnished by Analog Devices is believed to be accurate and reliable. However, no responsibility is assumed by Analog Devices for its use, nor for any infringements of patents or other rights of third parties that may result from its use. Specifications subject to change without notice. No license is granted by implication or otherwise under any patent or patent rights of Analog Devices. Trademarks and registered trademarks are the property of their respective owners.

FUNCTIONAL BLOCK DIAGRAM

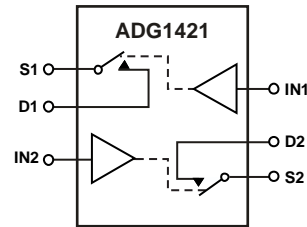

SWITCHES SHOWN FOR A LOGIC 0 INPUT

08487-001

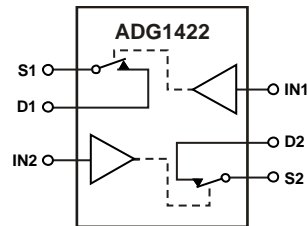
 Figure 1. [ADG1421](#) Functional Block Diagram

SWITCHES SHOWN FOR A LOGIC 0 INPUT

08487-002

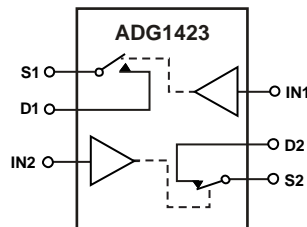
 Figure 2. [ADG1422](#) Functional Block Diagram

SWITCHES SHOWN FOR A LOGIC 0 INPUT

08487-003

 Figure 3. [ADG1423](#) Functional Block Diagram

The on resistance profile is very flat over the full analog input range ensuring excellent linearity and low distortion when switching audio signals. The iCMOS construction ensures ultralow power dissipation, making the part ideally suited for portable and battery-powered instruments.

PRODUCT HIGHLIGHTS

1. 2.4 Ω maximum on resistance at 25°C.
2. Minimum distortion.
3. 3 V logic-compatible digital inputs: $V_{INH} = 2.0$ V, $V_{INL} = 0.8$ V.
4. No V_L logic power supply required.
5. 10-lead MSOP and 10-lead, 3 mm \times 3 mm LFCSP packages.

TABLE OF CONTENTS

Features	1	Continuous Current per Channel, S or D	6
Applications	1	Absolute Maximum Ratings	7
General Description	1	Thermal Resistance	7
Functional Block Diagram	1	ESD Caution.....	7
Product Highlights	1	Pin Configuration and Function Descriptions.....	8
Revision History	2	Typical Performance Characteristics	9
Specifications.....	3	Test Circuits.....	12
±15 V Dual Supply	3	Terminology	14
+12 V Single Supply	4	Outline Dimensions	15
±5 V Dual Supply	5	Ordering Guide	16

REVISION HISTORY

7/14—Rev. 0 to Rev. A

Changes to Table 1	3
Updated Outline Dimensions	15

10/09—Revision 0: Initial Version

SPECIFICATIONS

±15 V DUAL SUPPLY

$V_{DD} = +15\text{ V} \pm 10\%$, $V_{SS} = -15\text{ V} \pm 10\%$, GND = 0 V, unless otherwise noted.

Table 1.

Parameter	25°C	-40°C to +85°C	-40°C to +105°C	-40°C to +125°C	Unit	Test Conditions/Comments
ANALOG SWITCH						
Analog Signal Range				V_{DD} to V_{SS}	V	
On Resistance, R_{ON}	2.1				Ω typ	$V_S = \pm 10\text{ V}$, $I_S = -10\text{ mA}$; see Figure 23
	2.4	2.8	2.95	3.2	Ω max	$V_{DD} = +13.5\text{ V}$, $V_{SS} = -13.5\text{ V}$
On Resistance Match Between Channels, ΔR_{ON}	0.02				Ω typ	$V_S = \pm 10\text{ V}$, $I_S = -10\text{ mA}$
	0.1	0.12	0.124	0.13	Ω max	
On Resistance Flatness, $R_{FLAT(ON)}$	0.4				Ω typ	$V_S = \pm 10\text{ V}$, $I_S = -10\text{ mA}$
	0.5	0.6	0.63	0.65	Ω max	
LEAKAGE CURRENTS						
Source Off Leakage, I_S (Off)	± 0.1				nA typ	$V_{DD} = +16.5\text{ V}$, $V_{SS} = -16.5\text{ V}$
	± 0.5	± 2	± 9	± 75	nA max	$V_S = \pm 10\text{ V}$, $V_D = \pm 10\text{ V}$; see Figure 24
Drain Off Leakage, I_D (Off)	± 0.1				nA typ	$V_S = \pm 10\text{ V}$, $V_D = \pm 10\text{ V}$; see Figure 24
	± 0.5	± 2	± 9	± 75	nA max	
Channel On Leakage, I_D , I_S (On)	± 0.2				nA typ	$V_S = V_D = \pm 10\text{ V}$; see Figure 25
	± 1	± 2	± 9	± 75	nA max	
DIGITAL INPUTS						
Input High Voltage, V_{INH}				2.0	V min	
Input Low Voltage, V_{INL}				0.8	V max	
Input Current, I_{INL} or I_{INH}	0.005				μA typ	$V_{IN} = V_{GND}$ or V_{DD}
				± 0.1	μA max	
Digital Input Capacitance, C_{IN}	4				pF typ	
DYNAMIC CHARACTERISTICS¹						
t_{ON}	115				ns typ	$R_L = 300\ \Omega$, $C_L = 35\text{ pF}$
	145	180		210	ns max	$V_S = 10\text{ V}$; see Figure 26
t_{OFF}	115				ns typ	$R_L = 300\ \Omega$, $C_L = 35\text{ pF}$
	145	165		190	ns max	$V_S = 10\text{ V}$; see Figure 26
Break-Before-Make Time Delay, t_D (ADG1423 Only)	45				ns typ	$R_L = 300\ \Omega$, $C_L = 35\text{ pF}$
				30	ns min	$V_{S1} = V_{S2} = 10\text{ V}$; see Figure 27
Charge Injection	-5				pC typ	$V_S = 0\text{ V}$, $R_S = 0\ \Omega$, $C_L = 1\text{ nF}$; see Figure 28
Off Isolation	-64				dB typ	$R_L = 50\ \Omega$, $C_L = 5\text{ pF}$, $f = 1\text{ MHz}$; see Figure 29
Channel-to-Channel Crosstalk	-74				dB typ	$R_L = 50\ \Omega$, $C_L = 5\text{ pF}$, $f = 1\text{ MHz}$; see Figure 30
Total Harmonic Distortion + Noise	0.016				% typ	$R_L = 10\text{ k}\Omega$, 5 V rms , $f = 20\text{ Hz}$ to 20 kHz ; see Figure 32
-3 dB Bandwidth	180				MHz typ	$R_L = 50\ \Omega$, $C_L = 5\text{ pF}$; see Figure 31
Insertion Loss	0.12				dB typ	$R_L = 50\ \Omega$, $C_L = 5\text{ pF}$, $f = 1\text{ MHz}$; see Figure 31
C_S (Off)	18				pF typ	$f = 1\text{ MHz}$; $V_S = 0\text{ V}$
C_D (Off)	22				pF typ	$f = 1\text{ MHz}$; $V_S = 0\text{ V}$
C_D , C_S (On)	86				pF typ	$f = 1\text{ MHz}$; $V_S = 0\text{ V}$
POWER REQUIREMENTS						
I_{DD}	0.002				μA typ	$V_{DD} = +16.5\text{ V}$, $V_{SS} = -16.5\text{ V}$
				1.0	μA max	Digital inputs = 0 V or V_{DD}
I_{DD}	120				μA typ	Digital inputs = 5 V
				190	μA max	
I_{SS}	0.002				μA typ	Digital inputs = 0 V, 5 V, or V_{DD}
				1.0	μA max	
V_{DD}/V_{SS}				$\pm 4.5/\pm 16.5$	V min/max	Ground = 0 V

¹ Guaranteed by design, not subject to production test.

+12 V SINGLE SUPPLY

$V_{DD} = 12\text{ V} \pm 10\%$, $V_{SS} = 0\text{ V}$, $GND = 0\text{ V}$, unless otherwise noted.

Table 2.

Parameter	25°C	-40°C to +85°C	-40°C to +125°C	Unit	Test Conditions/Comments
ANALOG SWITCH					
Analog Signal Range			0 V to V_{DD}	V	
On Resistance, R_{ON}	4			Ω typ	$V_S = 0\text{ V to }10\text{ V}$, $I_S = -10\text{ mA}$; see Figure 23
	4.6	5.5	6.2	Ω max	$V_{DD} = 10.8\text{ V}$, $V_{SS} = 0\text{ V}$
On Resistance Match Between Channels, ΔR_{ON}	0.03			Ω typ	$V_S = 0\text{ V to }10\text{ V}$, $I_S = -10\text{ mA}$
	0.15	0.17	0.18	Ω max	
On Resistance Flatness, $R_{FLAT(ON)}$	1.2			Ω typ	$V_S = 0\text{ V to }10\text{ V}$, $I_S = -10\text{ mA}$
	1.5	1.75	1.9	Ω max	
LEAKAGE CURRENTS					
Source Off Leakage, I_S (Off)	± 0.05			nA typ	$V_{DD} = 13.2\text{ V}$, $V_{SS} = 0\text{ V}$
	± 0.5	± 2	± 75	nA max	$V_S = 1\text{ V}/10\text{ V}$, $V_D = 10\text{ V}/1\text{ V}$; see Figure 24
Drain Off Leakage, I_D (Off)	± 0.05			nA typ	$V_S = 1\text{ V}/10\text{ V}$, $V_D = 10\text{ V}/1\text{ V}$; see Figure 24
	± 0.5	± 2	± 75	nA max	
Channel On Leakage, I_D , I_S (On)	± 0.1			nA typ	$V_S = V_D = 1\text{ V or }10\text{ V}$; see Figure 25
	± 1	± 2	± 75	nA max	
DIGITAL INPUTS					
Input High Voltage, V_{INH}			2.0	V min	
Input Low Voltage, V_{INL}			0.8	V max	
Input Current, I_{INL} or I_{INH}	0.005			μA typ	$V_{IN} = V_{GND}$ or V_{DD}
			± 0.1	μA max	
Digital Input Capacitance, C_{IN}	4			pF typ	
DYNAMIC CHARACTERISTICS¹					
t_{ON}	180			ns typ	$R_L = 300\ \Omega$, $C_L = 35\text{ pF}$
	230	295	340	ns max	$V_S = 8\text{ V}$; see Figure 26
t_{OFF}	130			ns typ	$R_L = 300\ \Omega$, $C_L = 35\text{ pF}$
	165	205	235	ns max	$V_S = 8\text{ V}$; see Figure 26
Break-Before-Make Time Delay, t_D (ADG1423 Only)	70			ns typ	$R_L = 300\ \Omega$, $C_L = 35\text{ pF}$
			48	ns min	$V_{S1} = V_{S2} = 8\text{ V}$; see Figure 27
Charge Injection	30			pC typ	$V_S = 6\text{ V}$, $R_S = 0\ \Omega$, $C_L = 1\text{ nF}$; see Figure 28
Off Isolation	-60			dB typ	$R_L = 50\ \Omega$, $C_L = 5\text{ pF}$, $f = 1\text{ MHz}$; see Figure 29
Channel-to-Channel Crosstalk	-70			dB typ	$R_L = 50\ \Omega$, $C_L = 5\text{ pF}$, $f = 1\text{ MHz}$; see Figure 30
-3 dB Bandwidth	140			MHz typ	$R_L = 50\ \Omega$, $C_L = 5\text{ pF}$; see Figure 31
Insertion Loss	0.26			dB typ	$R_L = 50\ \Omega$, $C_L = 5\text{ pF}$, $f = 1\text{ MHz}$; see Figure 31
C_S (Off)	31			pF typ	$f = 1\text{ MHz}$; $V_S = 6\text{ V}$
C_D (Off)	36			pF typ	$f = 1\text{ MHz}$; $V_S = 6\text{ V}$
C_D , C_S (On)	90			pF typ	$f = 1\text{ MHz}$; $V_S = 6\text{ V}$
POWER REQUIREMENTS					
I_{DD}	0.001			μA typ	$V_{DD} = 13.2\text{ V}$
			1.0	μA max	Digital inputs = 0 V or V_{DD}
I_{DD}	120			μA typ	Digital inputs = 5 V
			190	μA max	
V_{DD}			5/16.5	V min/max	Ground = 0 V, $V_{SS} = 0\text{ V}$

¹ Guaranteed by design, not subject to production test.

±5 V DUAL SUPPLY

$V_{DD} = +5\text{ V} \pm 10\%$, $V_{SS} = -5\text{ V} \pm 10\%$, $GND = 0\text{ V}$, unless otherwise noted.

Table 3.

Parameter	25°C	-40°C to +85°C	-40°C to +125°C	Unit	Test Conditions/Comments
ANALOG SWITCH					
Analog Signal Range			V_{DD} to V_{SS}	V	
On Resistance, R_{ON}	4.5			Ω typ	$V_S = \pm 4.5\text{ V}$, $I_S = -10\text{ mA}$; see Figure 23
	5.2	6.2	7	Ω max	$V_{DD} = +4.5\text{ V}$, $V_{SS} = -4.5\text{ V}$
On Resistance Match Between Channels, ΔR_{ON}	0.04			Ω typ	$V_S = \pm 4.5\text{ V}$; $I_S = -10\text{ mA}$
	0.18	0.2	0.21	Ω max	
On Resistance Flatness, $R_{FLAT(ON)}$	1.3			Ω typ	$V_S = \pm 4.5\text{ V}$, $I_S = -10\text{ mA}$
	1.6	1.85	2	Ω max	
LEAKAGE CURRENTS					
Source Off Leakage, I_S (Off)	± 0.05			nA typ	$V_{DD} = +5.5\text{ V}$, $V_{SS} = -5.5\text{ V}$
	± 0.5	± 2	± 75	nA max	$V_S = \pm 4.5\text{ V}$, $V_D = \mp 4.5\text{ V}$; see Figure 24
Drain Off Leakage, I_D (Off)	± 0.05			nA typ	$V_S = \pm 4.5\text{ V}$, $V_D = \mp 4.5\text{ V}$; see Figure 24
	± 0.5	± 2	± 75	nA max	
Channel On Leakage, I_D , I_S (On)	± 0.1	± 2	± 75	nA typ	$V_S = V_D = \pm 4.5\text{ V}$; see Figure 25
	± 1	± 2	± 75	nA max	
DIGITAL INPUTS					
Input High Voltage, V_{INH}			2.0	V min	
Input Low Voltage, V_{INL}			0.8	V max	
Input Current, I_{INL} or I_{INH}	0.005			μA typ	$V_{IN} = V_{GND}$ or V_{DD}
			± 0.1	μA max	
Digital Input Capacitance, C_{IN}	4			pF typ	
DYNAMIC CHARACTERISTICS¹					
t_{ON}	285			ns typ	$R_L = 300\ \Omega$, $C_L = 35\text{ pF}$
	370	460	520	ns max	$V_S = 3\text{ V}$; see Figure 26
t_{OFF}	220			ns typ	$R_L = 300\ \Omega$, $C_L = 35\text{ pF}$
	295	350	395	ns max	$V_S = 3\text{ V}$; see Figure 26
Break-Before-Make Time Delay, t_D (ADG1423 Only)	85			ns typ	$R_L = 300\ \Omega$, $C_L = 35\text{ pF}$
			45	ns min	$V_{S1} = V_{S2} = 3\text{ V}$; see Figure 27
Charge Injection	82			pC typ	$V_S = 0\text{ V}$, $R_S = 0\ \Omega$, $C_L = 1\text{ nF}$; see Figure 28
Off Isolation	-60			dB typ	$R_L = 50\ \Omega$, $C_L = 5\text{ pF}$, $f = 1\text{ MHz}$; see Figure 29
Channel-to-Channel Crosstalk	-70			dB typ	$R_L = 50\ \Omega$, $C_L = 5\text{ pF}$, $f = 1\text{ MHz}$; see Figure 30
Total Harmonic Distortion + Noise	0.04			% typ	$R_L = 10\text{ k}\Omega$, 5 V p-p, $f = 20\text{ Hz}$ to 20 kHz; see Figure 32
-3 dB Bandwidth	150			MHz typ	$R_L = 50\ \Omega$, $C_L = 5\text{ pF}$; see Figure 31
Insertion Loss	0.25			dB typ	$R_L = 50\ \Omega$, $C_L = 5\text{ pF}$, $f = 1\text{ MHz}$; see Figure 31
C_S (Off)	25			pF typ	$V_S = 0\text{ V}$, $f = 1\text{ MHz}$
C_D (Off)	30			pF typ	$V_S = 0\text{ V}$, $f = 1\text{ MHz}$
C_D , C_S (On)	100			pF typ	$V_S = 0\text{ V}$, $f = 1\text{ MHz}$
POWER REQUIREMENTS					
I_{DD}	0.001			μA typ	$V_{DD} = 5.5\text{ V}$, $V_{SS} = -5.5\text{ V}$
			1.0	μA max	Digital inputs = 0 V or V_{DD}
I_{SS}	0.001			μA typ	Digital inputs = 0 V or V_{DD}
			1.0	μA max	
V_{DD}/V_{SS}			$\pm 4.5/\pm 16.5$	V min/max	Ground = 0 V

¹ Guaranteed by design, not subject to production test.

CONTINUOUS CURRENT PER CHANNEL, S OR D

Table 4.

Parameter	25°C	85°C	125°C	Unit	Test Conditions/Comments
CONTINUOUS CURRENT PER CHANNEL ¹					
±15 V Dual Supply					$V_{DD} = +13.5\text{ V}, V_{SS} = -13.5\text{ V}$
10-Lead MSOP ($\theta_{JA} = 142^\circ\text{C/W}$)	185	120	75	mA maximum	
10-Lead LFCSP ($\theta_{JA} = 76^\circ\text{C/W}$)	250	155	85	mA maximum	
+12 V Single Supply					$V_{DD} = 10.8\text{ V}, V_{SS} = 0\text{ V}$
10-Lead MSOP ($\theta_{JA} = 142^\circ\text{C/W}$)	150	100	65	mA maximum	
10-Lead LFCSP ($\theta_{JA} = 76^\circ\text{C/W}$)	205	130	80	mA maximum	
±5 V Dual Supply					$V_{DD} = +4.5\text{ V}, V_{SS} = -4.5\text{ V}$
10-Lead MSOP ($\theta_{JA} = 142^\circ\text{C/W}$)	145	100	65	mA maximum	
10-Lead LFCSP ($\theta_{JA} = 76^\circ\text{C/W}$)	195	125	75	mA maximum	

¹ Guaranteed by design, not subject to production test.

ABSOLUTE MAXIMUM RATINGS

$T_A = 25^\circ\text{C}$, unless otherwise noted.

Table 5.

Parameter	Rating
V_{DD} to V_{SS}	35 V
V_{DD} to GND	-0.3 V to +25 V
V_{SS} to GND	+0.3 V to -25 V
Analog Inputs ¹	$V_{SS} - 0.3\text{ V}$ to $V_{DD} + 0.3\text{ V}$ or 30 mA, whichever occurs first
Digital Inputs ¹	GND - 0.3 V to $V_{DD} + 0.3\text{ V}$ or 30 mA, whichever occurs first
Peak Current, S or D (Pulsed at 1 ms, 10% Duty-Cycle Maximum)	
10-Lead MSOP (4-Layer Board)	300 mA
10-Lead LFCSP	400 mA
Continuous Current per Channel, S or D	Data in Table 4 + 15% mA
Operating Temperature Range Industrial	-40°C to +125°C
Storage Temperature Range	-65°C to +150°C
Junction Temperature	150°C
Reflow Soldering Peak Temperature, Pb Free	260°C

¹ Over voltages at IN, S, or D are clamped by internal diodes. Current should be limited to the maximum ratings given.

Stresses above those listed under Absolute Maximum Ratings may cause permanent damage to the device. This is a stress rating only; functional operation of the device at these or any other conditions above those indicated in the operational section of this specification is not implied. Exposure to absolute maximum rating conditions for extended periods may affect device reliability.

THERMAL RESISTANCE

Table 6. Thermal Resistance

Package Type	θ_{JA}	θ_{JC}	Unit
10-Lead MSOP (4-Layer Board)	142	44	°C/W
10-Lead LFCSP	76		°C/W

ESD CAUTION



ESD (electrostatic discharge) sensitive device. Charged devices and circuit boards can discharge without detection. Although this product features patented or proprietary protection circuitry, damage may occur on devices subjected to high energy ESD. Therefore, proper ESD precautions should be taken to avoid performance degradation or loss of functionality.

PIN CONFIGURATIONS AND FUNCTION DESCRIPTIONS

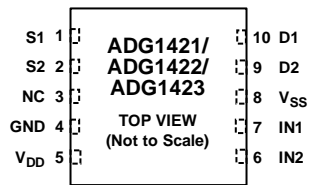

- NOTES
 1. EXPOSED PAD TIED TO SUBSTRATE, V_{SS} .
 2. NC = NO CONNECT

Figure 4. 10-Lead LFCSP Pin Configuration



NC = NO CONNECT

Figure 5. 10-Lead MSOP Pin Configuration

Table 7. 10-Lead LFCSP Pin Function Descriptions

Pin No.	Mnemonic	Description
1	S1	Source Terminal. This pin can be an input or output.
2	S2	Source Terminal. This pin can be an input or output.
3	NC	No Connect.
4	GND	Ground (0 V) Reference.
5	V_{DD}	Most Positive Power Supply Potential.
6	IN2	Logic Control Input.
7	IN1	Logic Control Input.
8	V_{SS}	Most Negative Power Supply Potential.
9	D2	Drain Terminal. This pin can be an input or output.
10	D1	Drain Terminal. This pin can be an input or output.
	EPAD	Exposed pad tied to substrate, V_{SS} .

Table 8. 10-Lead MSOP Pin Function Descriptions

Pin No.	Mnemonic	Description
1	S1	Source Terminal. This pin can be an input or output.
2	S2	Source Terminal. This pin can be an input or output.
3	NC	No Connect.
4	GND	Ground (0 V) Reference.
5	V_{DD}	Most Positive Power Supply Potential.
6	IN2	Logic Control Input.
7	IN1	Logic Control Input.
8	V_{SS}	Most Negative Power Supply Potential.
9	D2	Drain Terminal. This pin can be an input or output.
10	D1	Drain Terminal. This pin can be an input or output.

Table 9. ADG1421/ADG1422 Truth Table

ADG1421 INx	ADG1422 INx	Switch Condition
1	0	On
0	1	Off

Table 10. ADG1423 Truth Table

ADG1423 INx	Switch 1 Condition	Switch 2 Condition
0	Off	On
1	On	Off

TYPICAL PERFORMANCE CHARACTERISTICS

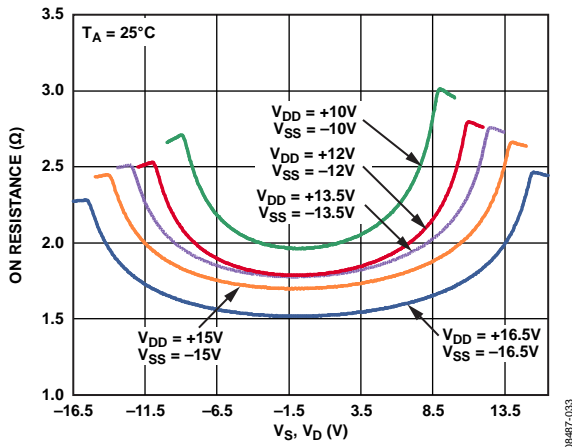

Figure 6. On Resistance as a Function of V_D (V_S) for Dual Supply

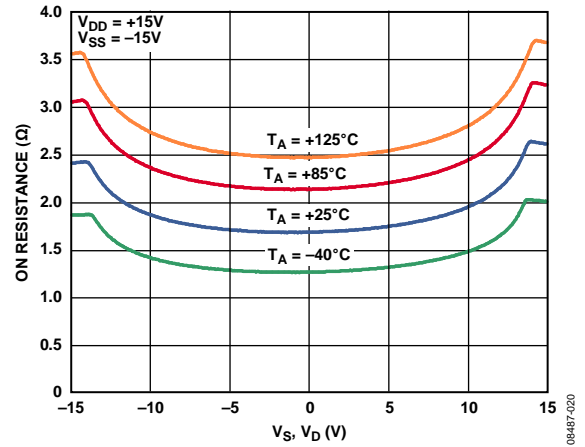

Figure 9. On Resistance as a Function of V_D (V_S) for Different Temperatures, ± 15 V Dual Supply



Figure 7. On Resistance as a Function of V_D (V_S) for Single Supply

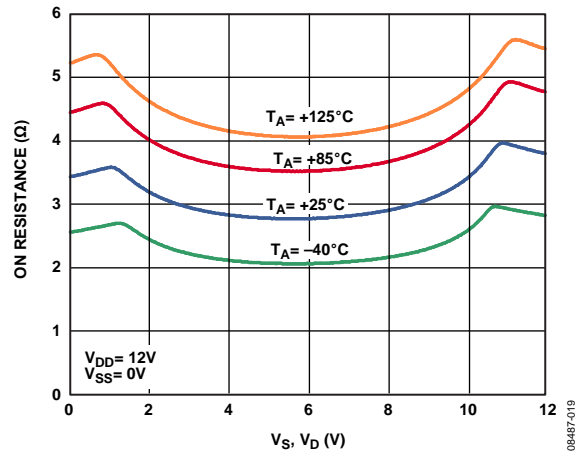

Figure 10. On Resistance as a Function of V_D (V_S) for Different Temperatures, +12 V Single Supply



Figure 8. On Resistance as a Function of V_D (V_S) for Dual Supply

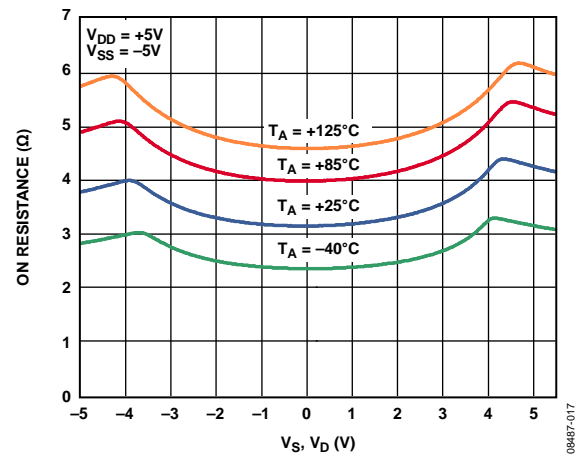

Figure 11. On Resistance as a Function of V_D (V_S) for Different Temperatures, ± 5 V Dual Supply

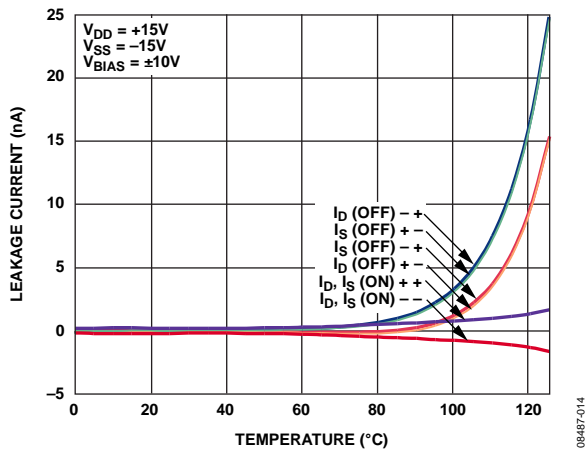

Figure 12. Leakage Currents as a Function of Temperature, ±15 V Dual Supply

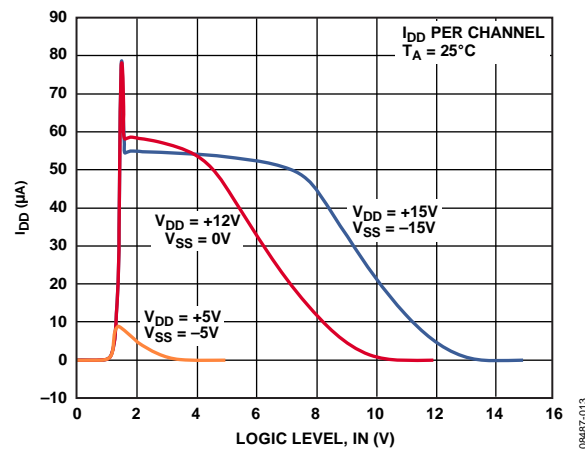

Figure 15. I_{DD} vs. Logic Level

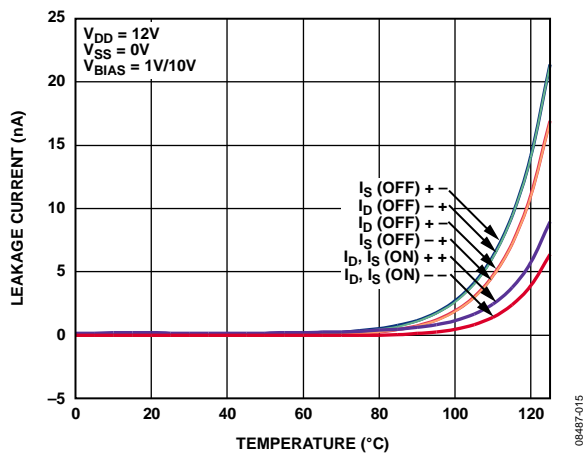

Figure 13. Leakage Currents as a Function of Temperature, +12 V Single Supply

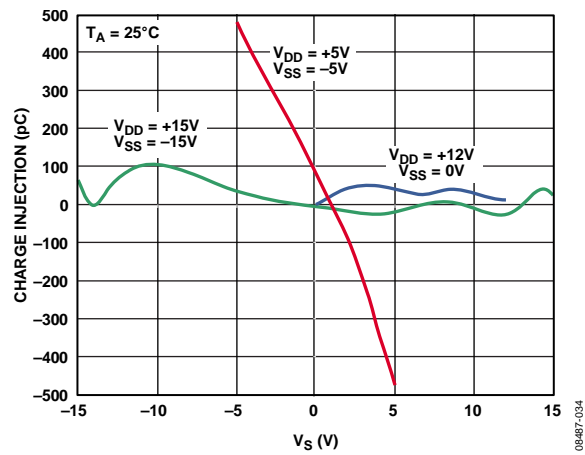

Figure 16. Charge Injection vs. Source Voltage

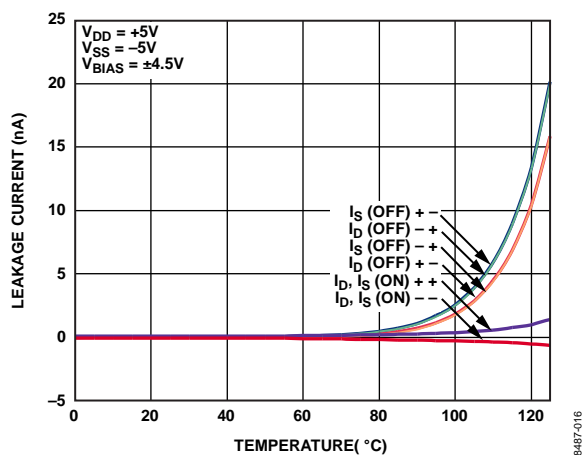

Figure 14. Leakage Currents as a Function of Temperature, ±5 V Dual Supply

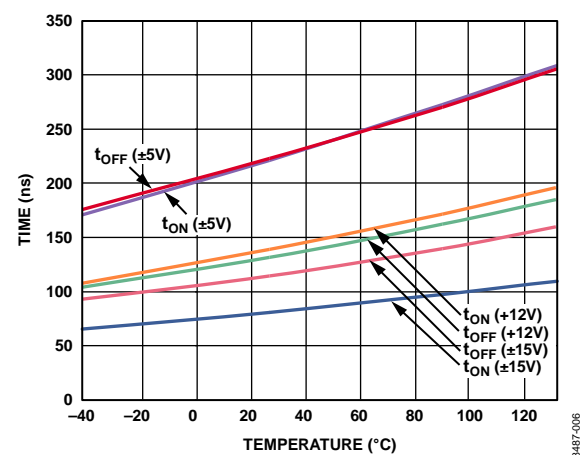

Figure 17. $t_{TRANSITION}$ Times vs. Temperature

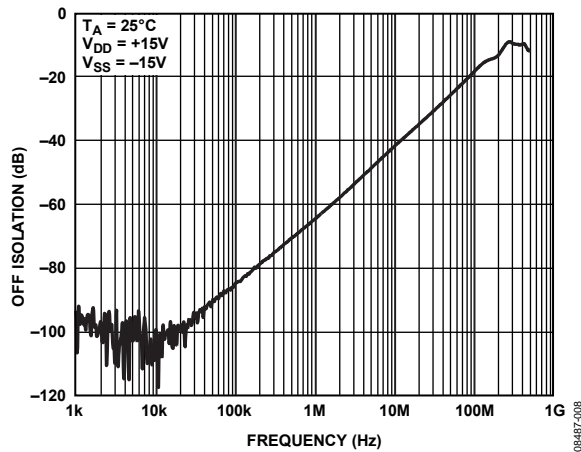

Figure 18. Off Isolation vs. Frequency

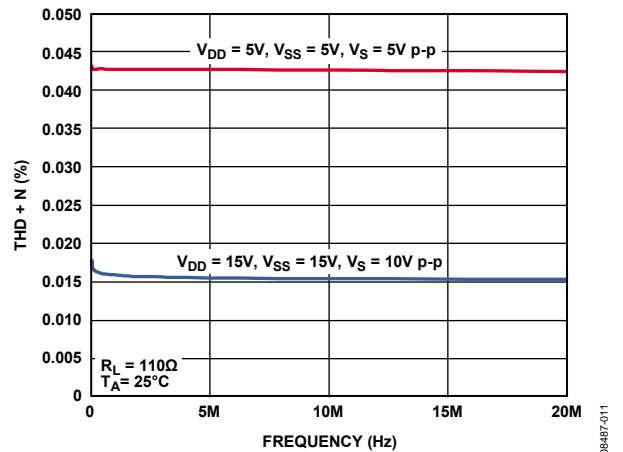

Figure 21. THD + N vs. Frequency

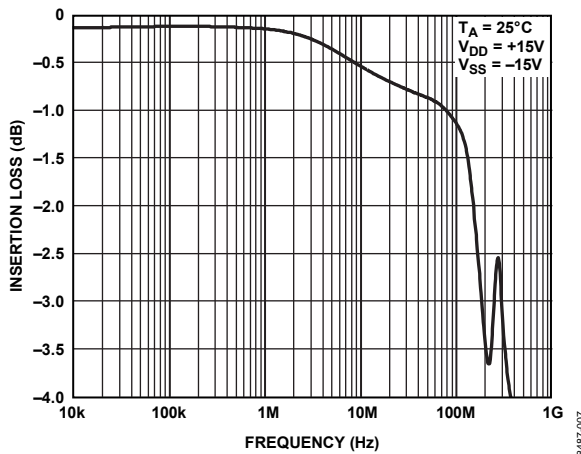

Figure 19. On Response vs. Frequency

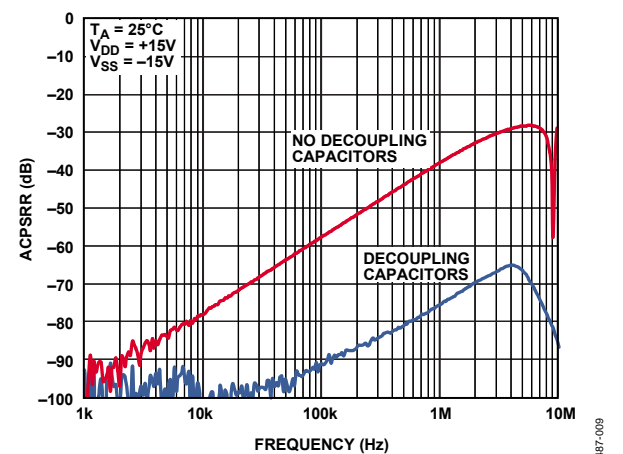

Figure 22. ACPSRR vs. Frequency

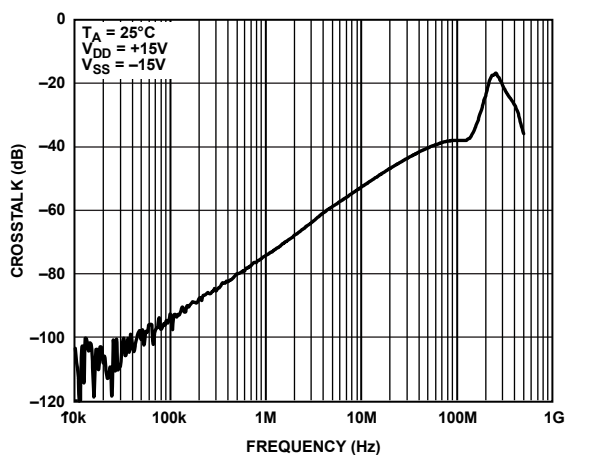

Figure 20. Crosstalk vs. Frequency

08487-008

08487-011

08487-007

08487-009

08487-012

TEST CIRCUITS



Figure 23. On Resistance

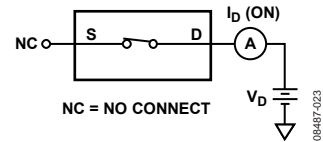

Figure 25. On Leakage



Figure 24. Off Leakage



Figure 26. Switching Times



Figure 27. Break-Before-Make Time Delay

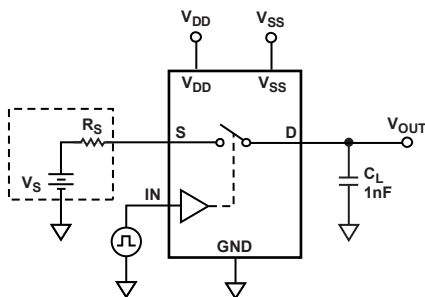

Figure 28. Charge Injection



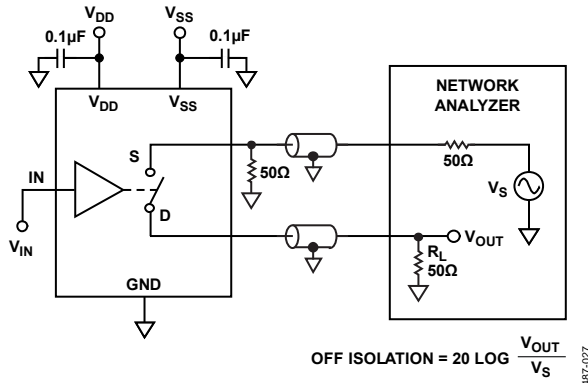

Figure 29. Off Isolation

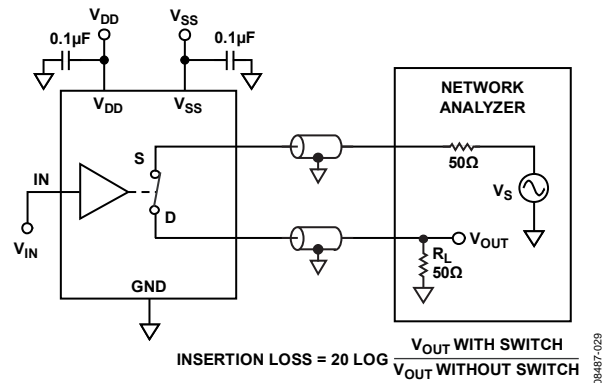

Figure 31. Bandwidth

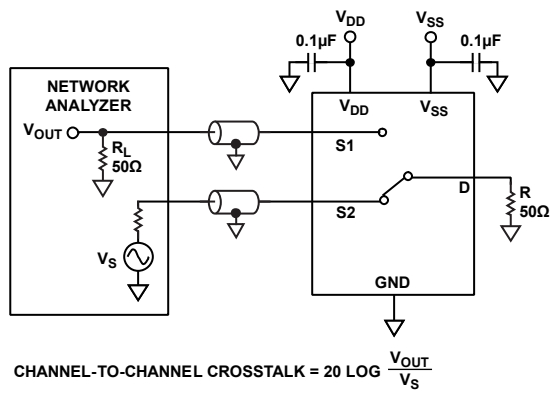

Figure 30. Channel-to-Channel Crosstalk

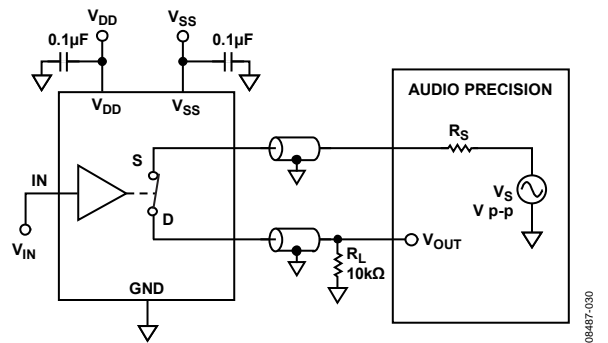

Figure 32. THD + N

08487-027

08487-029

08487-028

08487-030

TERMINOLOGY

I_{DD}

The positive supply current.

I_{SS}

The negative supply current.

V_D (V_S)

The analog voltage on Terminal D and Terminal S.

R_{ON}

The ohmic resistance between Terminal D and Terminal S.

R_{FLAT} (ON)

Flatness is defined as the difference between the maximum and minimum value of on resistance as measured over the specified analog signal range.

I_S (Off)

The source leakage current with the switch off.

I_D (Off)

The drain leakage current with the switch off.

I_D, I_S (On)

The channel leakage current with the switch on.

V_{INL}

The maximum input voltage for Logic 0.

V_{INH}

The minimum input voltage for Logic 1.

I_{INL} (I_{INH})

The input current of the digital input.

C_S (Off)

The off switch source capacitance, measured with reference to ground.

C_D (Off)

The off switch drain capacitance, measured with reference to ground.

C_D, C_S (On)

The on switch capacitance, measured with reference to ground.

C_{IN}

The digital input capacitance.

t_{ON} (EN)

Delay time between the 50% and 90% points of the digital input and switch on condition. See Figure 26.

t_{OFF} (EN)

Delay time between the 50% and 90% points of the digital input and switch off condition. See Figure 26.

$t_{TRANSITION}$

Delay time between the 50% and 90% points of the digital inputs and the switch on condition when switching from one address state to another.

T_{BBM}

Off time measured between the 80% point of both switches when switching from one address state to another. See Figure 27.

Charge Injection

A measure of the glitch impulse transferred from the digital input to the analog output during switching. See Figure 28.

Off Isolation

A measure of unwanted signal coupling through an off switch. See Figure 29.

Crosstalk

A measure of unwanted signal that is coupled through from one channel to another as a result of parasitic capacitance. See Figure 30.

Bandwidth

The frequency at which the output is attenuated by 3 dB. See Figure 31.

On Response

The frequency response of the on switch.

Insertion Loss

The loss due to the on resistance of the switch. See Figure 31.

THD + N

The ratio of the harmonic amplitude plus noise of the signal to the fundamental. See Figure 32.

AC Power Supply Rejection Ratio (ACPSRR)

ACPSRR measures the ability of a part to avoid coupling noise and spurious signals that appear on the supply voltage pin to the output of the switch. The dc voltage on the device is modulated by a sine wave of 0.62 V p-p. The ratio of the amplitude of signal on the output to the amplitude of the modulation is the ACPSRR. See Figure 22.

OUTLINE DIMENSIONS

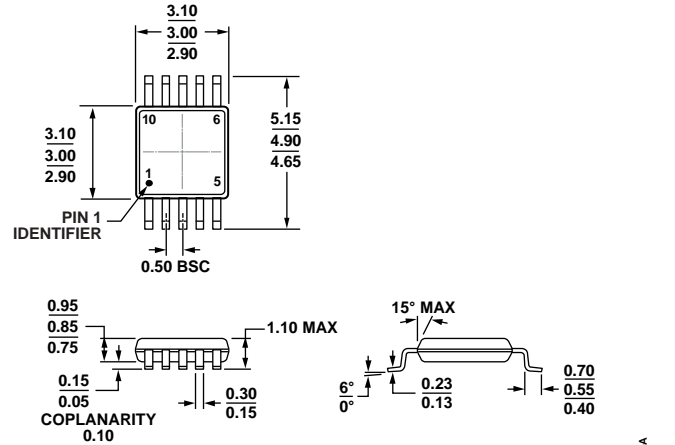

COMPLIANT TO JEDEC STANDARDS MO-187-BA

Figure 33. 10-Lead Mini Small Outline Package [MSOP] (RM-10)
Dimensions shown in millimeters

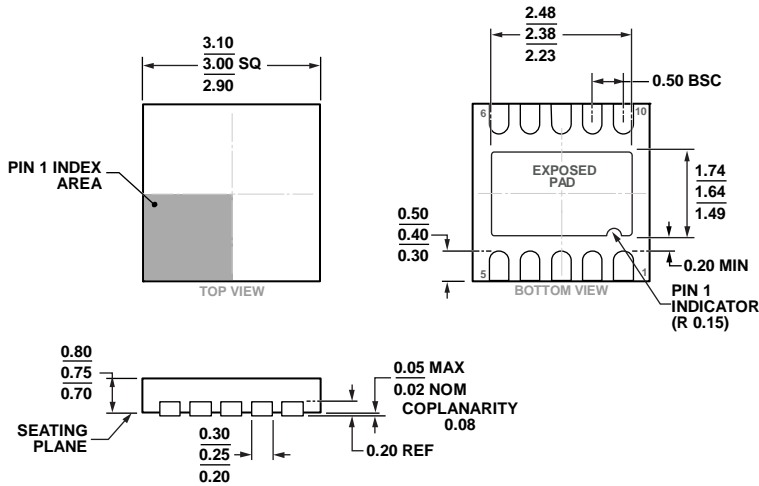

*FOR PROPER CONNECTION OF THE EXPOSED PAD, REFER TO THE PIN CONFIGURATIONS AND FUNCTION DESCRIPTIONS SECTION OF THIS DATA SHEET.

Figure 34. 10-Lead Lead Frame Chip Scale Package [LFCSP_WD]
3 mm x 3 mm Body, Very Very Thin, Dual Lead (CP-10-9)
Dimensions shown in millimeters

ORDERING GUIDE

Model ¹	Temperature Range	Package Description	Package Option	Branding
ADG1421BRMZ	-40°C to +125°C	10-Lead Mini Small Outline Package [MSOP]	RM-10	S2V
ADG1421BRMZ-REEL7	-40°C to +125°C	10-Lead Mini Small Outline Package [MSOP]	RM-10	S2V
ADG1421BCPZ-REEL7	-40°C to +125°C	10- Lead Frame Chip Scale Package [LFCSP_WD]	CP-10-9	S2V
ADG1422BRMZ	-40°C to +125°C	10-Lead Mini Small Outline Package [MSOP]	RM-10	S2W
ADG1422BRMZ-REEL7	-40°C to +125°C	10-Lead Mini Small Outline Package [MSOP]	RM-10	S2W
ADG1422BCPZ-REEL7	-40°C to +125°C	10- Lead Frame Chip Scale Package [LFCSP_WD]	CP-10-9	S2W
ADG1423BRMZ	-40°C to +125°C	10-Lead Mini Small Outline Package [MSOP]	RM-10	S2X
ADG1423BRMZ-REEL7	-40°C to +125°C	10-Lead Mini Small Outline Package [MSOP]	RM-10	S2X
ADG1423BCPZ-REEL7	-40°C to +125°C	10- Lead Frame Chip Scale Package [LFCSP_WD]	CP-10-9	S2X

¹ Z = RoHS Compliant Part.