

# PR-26-REFLECTOR ✓ ACTIVE

Raychem

TE Internal #: 991967-000

Heat Shrink Equipment, Discrete, Worldwide, Cable Assembly, Reflector, SolderSleeve Products

[View on TE.com >](#)



Application Tooling > Heat Shrink Equipment



Equipment Processing Type: **Discrete**

Heat Shrink Equipment Region: **Worldwide**

Heat Shrink Equipment Application: **Cable Assembly**

Tooling Type: **Reflector**

Spare Parts Tooling Type: **SolderSleeve Products**

## Features

### Product Type Features

Spare Parts Tooling Type	SolderSleeve Products
--------------------------	-----------------------

### Product Availability

Heat Shrink Equipment Region	Worldwide
------------------------------	-----------

### Other

Equipment Processing Type	Discrete
---------------------------	----------

Heat Shrink Equipment Application	Cable Assembly
-----------------------------------	----------------

Tooling Type	Reflector
--------------	-----------

## Product Compliance

[For compliance documentation, visit the product page on TE.com>](#)

EU RoHS Directive 2011/65/EU	Compliant
------------------------------	-----------

EU ELV Directive 2000/53/EC	Compliant
-----------------------------	-----------

China RoHS 2 Directive MIIT Order No 32, 2016	No Restricted Materials Above Threshold
---	---

EU REACH Regulation (EC) No. 1907/2006	Current ECHA Candidate List: JAN 2022 (223) Candidate List Declared Against: JUN 2020 (209) SVHC > Threshold: Not Yet Reviewed
--	---

Halogen Content	Low Halogen - Br, Cl, F, I < 900 ppm per homogenous material. Also BFR/CFR/PVC
-----------------	--

Free

Solder Process Capability

Not applicable for solder process capability

Product Compliance Disclaimer

This information is provided based on reasonable inquiry of our suppliers and represents our current actual knowledge based on the information they provided. This information is subject to change. The part numbers that TE has identified as EU RoHS compliant have a maximum concentration of 0.1% by weight in homogenous materials for lead, hexavalent chromium, mercury, PBB, PBDE, DBP, BBP, DEHP, DIBP, and 0.01% for cadmium, or qualify for an exemption to these limits as defined in the Annexes of Directive 2011/65/EU (RoHS2). Finished electrical and electronic equipment products will be CE marked as required by Directive 2011/65/EU. Components may not be CE marked. Additionally, the part numbers that TE has identified as EU ELV compliant have a maximum concentration of 0.1% by weight in homogenous materials for lead, hexavalent chromium, and mercury, and 0.01% for cadmium, or qualify for an exemption to these limits as defined in the Annexes of Directive 2000/53/EC (ELV). Regarding the REACH Regulation, the information TE provides on SVHC in articles for this part number is based on the latest European Chemicals Agency (ECHA) 'Guidance on requirements for substances in articles' posted at this URL: <https://echa.europa.eu/guidance-documents/guidance-on-reach>

### Compatible Parts

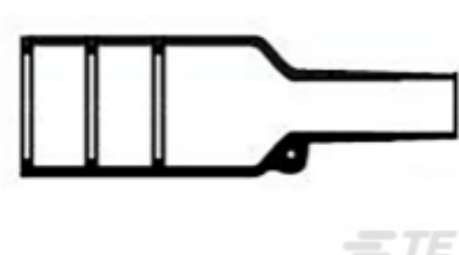

TE Part # CAT-R21-731072  
Bulbous Heat Shrink Boots: Lipped, Straight

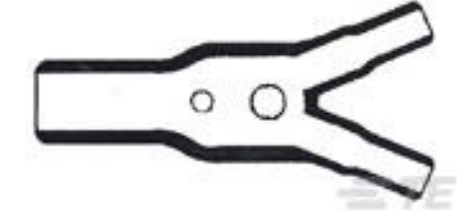

TE Part # 831991-000  
382W042-25/225-0



TE Part # CAT-R21-7310723  
Low Profile Heat Shrink Boots: Poly Molded, Lipped, Straight



TE Part # CAT-R21-731055422  
Heat Shrink Boots: Poly Mold, Lipped



TE Part # CZ3443-000  
202D953-4-50/86-0

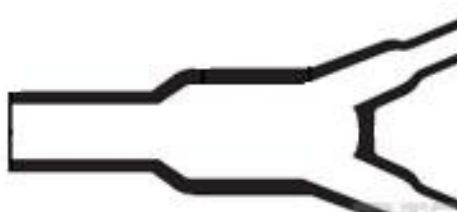

TE Part # F20649-000  
382A012-100-G05/86-0

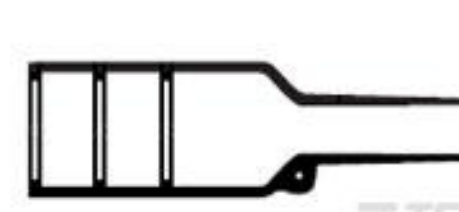

TE Part # 975754-000  
202K232-25-01/225-0



TE Part # CV1995-000  
203W301-100-G02/86-0



TE Part # 823662-000  
382A012-3-04/42-0

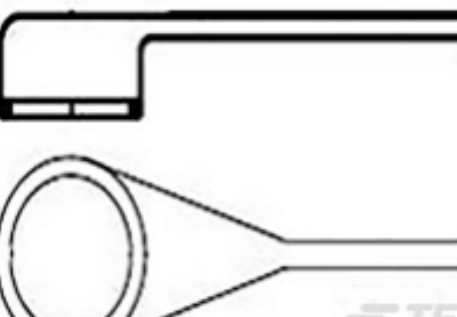

TE Part # 220507-000  
222D953-25-G05/225-0



TE Part # 881029-004  
222K185-25/225-CS-1858-0



TE Part # CZ1866-000  
302A821-4/86-0CS1821



TE Part # EK7266-000  
202S121-25C/86-0



TE Part # EK7270-000  
202S132-100C/86-0



TE Part # EK7272-000  
202S132-25C/86-0



TE Part # EK7275-000  
202S142-100C/86-0



TE Part # EM4332-000  
202S142-25C/86-0



TE Part # EK7279-000  
202S152-100C/86-0



TE Part # EK7281-000  
202S152-25C/86-0



TE Part # EK7284-000  
202S163-100C/86-0

### Customers Also Bought



TE Part #47386  
DAHT PG PIDG 26-16 ASSY



TE Part #991963-000  
PR-13-REFLECTOR



TE Part #989523-000  
PR-25D-REFLECTOR



TE Part #350550-2  
UMNL SOK 20-14 AU/BR L/P



TE Part #EG1100-000  
CV1983-ST-230V2300W-EU



TE Part #8913153001  
AFR35-240-0-0



TE Part #NB09056001  
ATUM-12/4-0-100MM



TE Part #711085-000  
55FB1544-24-FLT4-OCS2173



TE Part #CD60983001  
44A0111-14-9CK0300

### Documents



**Product Drawings**

[PR-26-REFLECTOR](#)

English

---

**Datasheets & Catalog Pages**

[RAYCHEM\\_TUBING\\_CATALOG\\_SEC2\\_APPLICATION\\_EQUIPMENT](#)

English

[Raychem Application Tooling](#)

English