

## RCMKITP-I 230VAC 4CO LD

**Weidmüller Interface GmbH & Co. KG**

Klingenbergstraße 26

D-32758 Detmold

Germany

www.weidmueller.com

### Product image

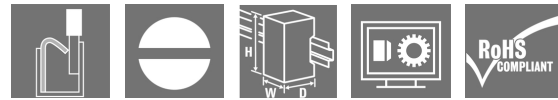
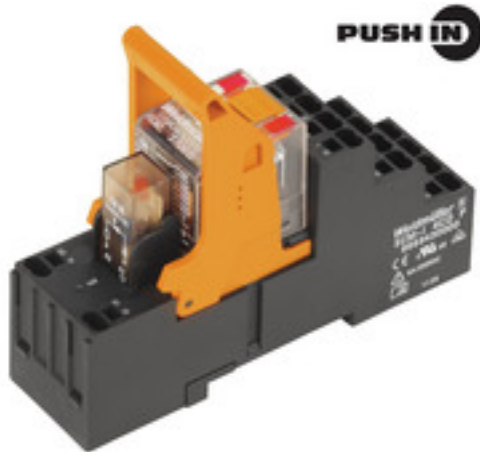

Similar to illustration

- Mounted kit consisting relay, socket and retaining clip
- 100 % function tested
- 100 % check of the dielectric strenght between input - output
- 4 CO contacts
- Test button with mechanical status indicator
- Bright status LED (AC coil: red / DC coil: green)
- Identification of coils (AC red / DC blue)

### General ordering data

Version	RIDERSERIES RCM, Relay module, Number of contacts: 4, CO contact AgNi, Rated control voltage: 230 V AC, Continuous current: 6 A, PUSH IN, Test button available: Yes
Order No.	<a href="#">8921150000</a>
Type	RCMKITP-I 230VAC 4CO LD
GTIN (EAN)	4032248692361
Qty.	10 pc(s).
Relevant rim module	<a href="#">8869650000</a>
Relevant base	<a href="#">8869430000</a>
Relevant relay	<a href="#">1181100000</a>

Creation date April 20, 2022 2:46:18 PM CEST

## RCMKITP-I 230VAC 4CO LD

Weidmüller Interface GmbH &amp; Co. KG

Klingenbergstraße 26

D-32758 Detmold

Germany

www.weidmueller.com

## Technical data

## Dimensions and weights

Depth	78.3 mm	Depth (inches)	3.083 inch
Height	98 mm	Height (inches)	3.858 inch
Width	28 mm	Width (inches)	1.102 inch
Net weight	97.45 g		

## Temperatures

Storage temperature	-40 °C...70 °C	Operating temperature	-40 °C...70 °C
Humidity	40 °C / 93 % rel. humidity, no condensation		

## Probability of failure

B10	140.000 AC15: 250Vac/4A
-----	----------------------------

## Environmental Product Compliance

REACH SVHC	Lead 7439-92-1
------------	----------------

## Control side

Rated control voltage	230 V AC	Rated current AC	5.7 mA
Power rating	1.31 VA	Pull-in/drop-out voltage, typ.	184 V / 69 V AC
Coil resistance	19465 $\Omega \pm 15\%$	Coil tolerance	15 %
Status indicator	red LED		

## Load side

Rated switching voltage	240 V AC	Continuous current	6 A
Max. switching frequency at rated load	0.1 Hz	Min. switching power	1 mA @ 24 V, 10 mA @ 12 V, 100 mA @ 5 V
Inrush current	12 A / 20 ms	AC switching capacity (resistive), max.	1500 VA
DC switching capacity (resistive), max.	144 W @ 24 V	Switch-on delay	$\leq 15$ ms
Switch-off delay	$\leq 10$ ms	Contact type	4 CO contact (AgNi)
Mechanical service life	AC coil $20 \times 10^6$ switching cycles, DC coil $30 \times 10^6$ switching cycles		

## General data

Rail	TS 35	Test button available	Yes
Version of test button	lockable	Mechanical switch position indicator	Yes
Colour	black		

## Insulation coordination

Rated voltage	250 V	Pollution severity	2
Surge voltage category	III	Insulating material group	IIIa
Clearance and creepage distances for control side - load side	$\geq 4$ mm	Dielectric strength for control side - load side	2.5 kV <sub>eff</sub> / 1 Min.
Dielectric strength of neighbouring contacts	2 kV <sub>eff</sub> / 1 min	Dielectric strength of open contact	1.2 kV <sub>eff</sub> / 1 min.
Impulse withstand voltage	5 kV (1.2/50 $\mu$ s)	Protection degree	IP20

Creation date April 20, 2022 2:46:18 PM CEST

Catalogue status 08.04.2022 / We reserve the right to make technical changes.

2

## RCMKITP-I 230VAC 4CO LD

Weidmüller Interface GmbH &amp; Co. KG

Klingenbergstraße 26

D-32758 Detmold

Germany

www.weidmueller.com

## Technical data

## Further details of approvals / standards

Certificate no. (CSA) relay	249409-2426937	Certificate no. (CSA) base	249409-2295474
Certificate No. (DNVGL)	TAA000011A	Certificate no. (cURus) relay	E224238
Certificate no. (cURus) base	E223759		

## Connection data

Wire connection method	PUSH IN	Stripping length, rated connection	12 mm
Clamping range, rated connection	1.5 mm <sup>2</sup>	Clamping range, min.	0.75 mm <sup>2</sup>
Clamping range, max.	1.5 mm <sup>2</sup>	Wire cross-section, solid, min.	0.75 mm <sup>2</sup>
Wire cross-section, solid, max.	1.5 mm <sup>2</sup>	Wire cross-section, solid, max. (AWG)	AWG 16
Wire connection cross section, finely stranded, min.	0.75 mm <sup>2</sup>	Wire connection cross section, finely stranded, max.	1.5 mm <sup>2</sup>
Wire cross-section, finely stranded, max. (AWG)	AWG 16	Wire connection cross-section, finely stranded with wire-end ferrules DIN 46228/4, min.	0.75 mm <sup>2</sup>
Wire connection cross-section, finely stranded with wire-end ferrules DIN 46228/4, max.	0.75 mm <sup>2</sup>	Conductor cross-section, flexible, AEH (DIN 46228-1), min.	0.75 mm <sup>2</sup>
Conductor cross-section, flexible, AEH (DIN 46228-1), max.	1 mm <sup>2</sup>	Blade size	0.6 x 3.5 mm

## Classifications

ETIM 6.0	EC001437	ETIM 7.0	EC001437
ETIM 8.0	EC001437	ECLASS 9.0	27-37-16-01
ECLASS 9.1	27-37-16-01	ECLASS 10.0	27-37-16-01
ECLASS 11.0	27-37-16-01		

## Approvals

Approvals



ROHS

Conform

## Downloads

Approval/Certificate/Document of Conformity	<a href="#">EU Konformitätserklärung / EU Declaration of Conformity</a>
Engineering Data	<a href="#">CAD data – STEP</a>
Engineering Data	<a href="#">EPLAN, WSCAD, Zuken E3.S</a>
Catalogues	<a href="#">Catalogues in PDF-format</a>
Brochures	

**RCMKITP-I 230VAC 4CO LD**

**Weidmüller Interface GmbH & Co. KG**  
 Klingenbergstraße 26  
 D-32758 Detmold  
 Germany

www.weidmueller.com

**Drawings**

**Wiring diagram**

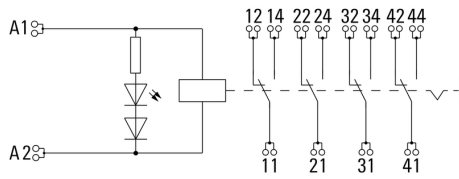

**Graph**

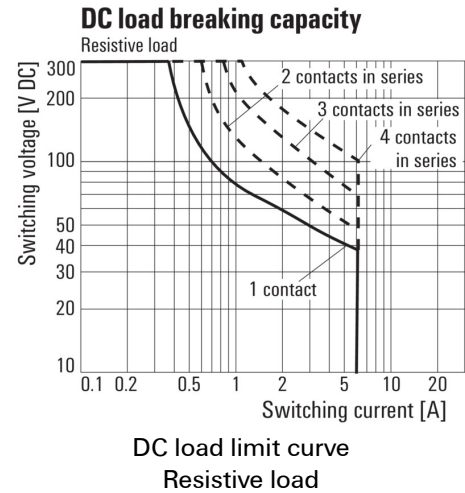

**Graph**

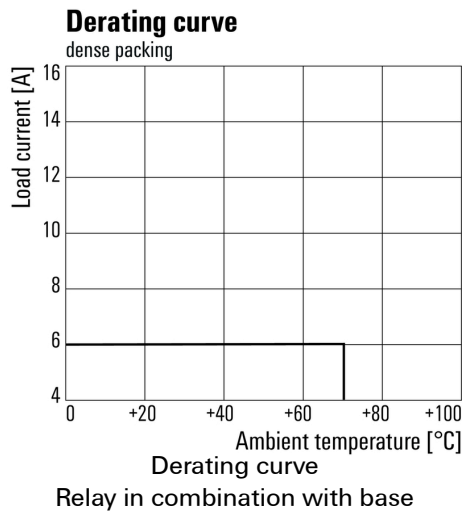

**Graph**

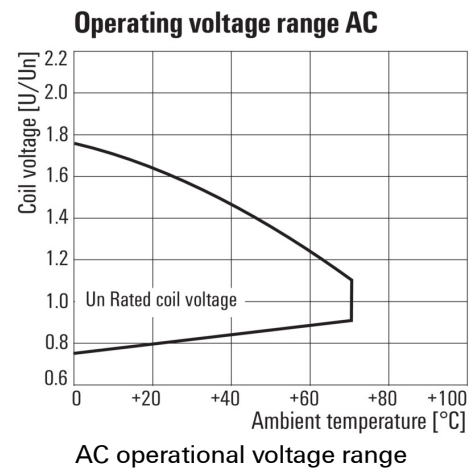

**Graph**

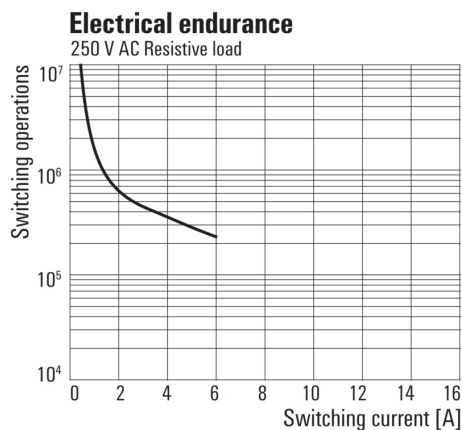

Electrical service life 250 V AC resistive load  
 250 V AC resistive load

**Dimensional drawing**

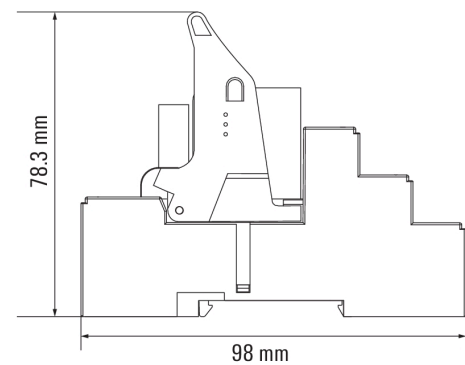

**Correct handling PUSH IN connection**



**Wrong handling PUSH IN connection**

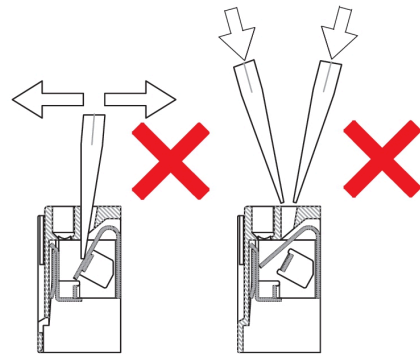

**Recommended screwdriver**



**RCMKITP-I 230VAC 4CO LD**

**Weidmüller Interface GmbH & Co. KG**  
 Klingenbergstraße 26  
 D-32758 Detmold  
 Germany

www.weidmueller.com

**Drawings**

