

**1-CONDUCTOR PCB TERMINAL
STRIP 2 SOLDER PINS / POLES
STAGGERED PIN SPACING 5 MM / 0.
197 IN WITH PUSH BUTTONS**

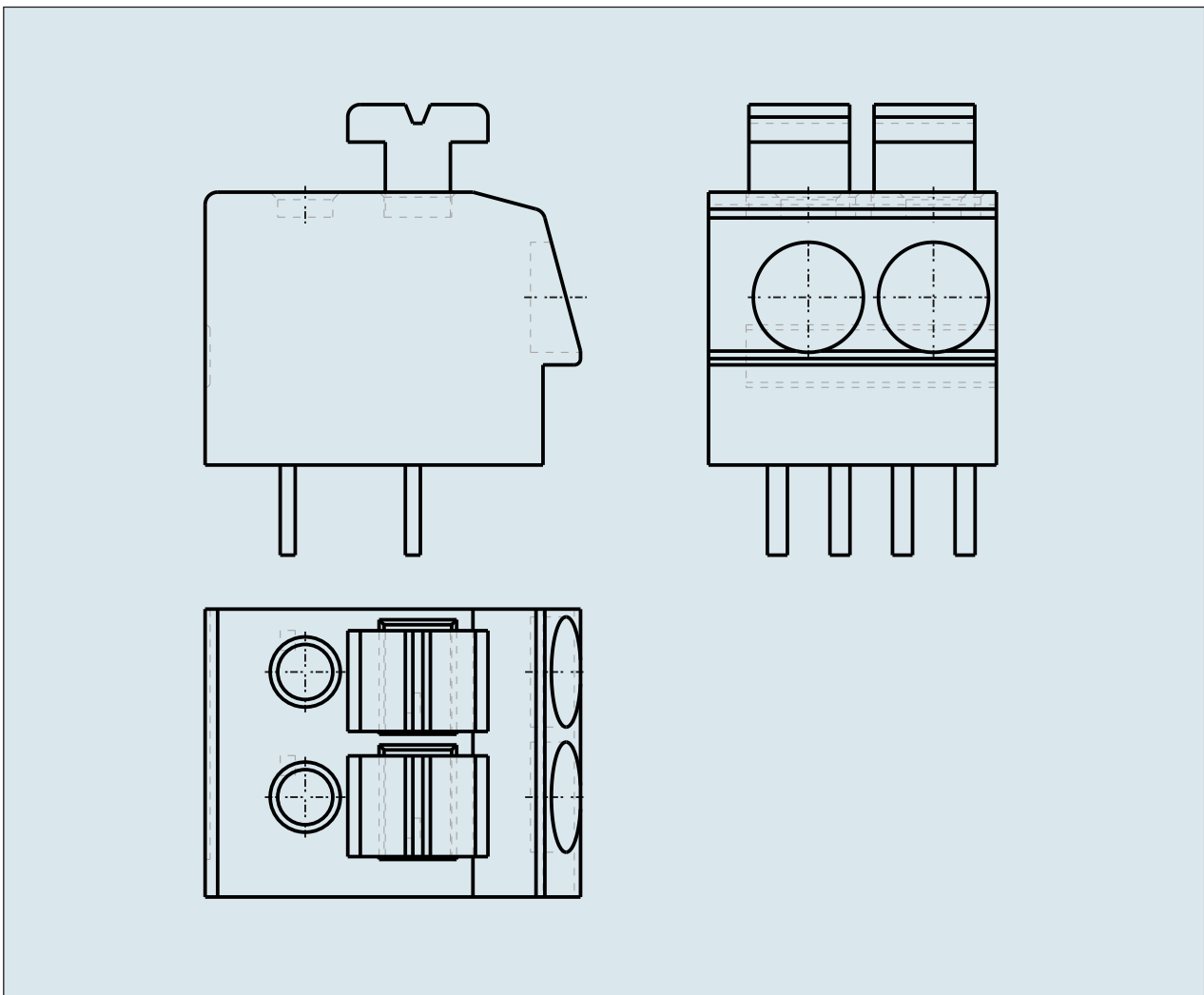
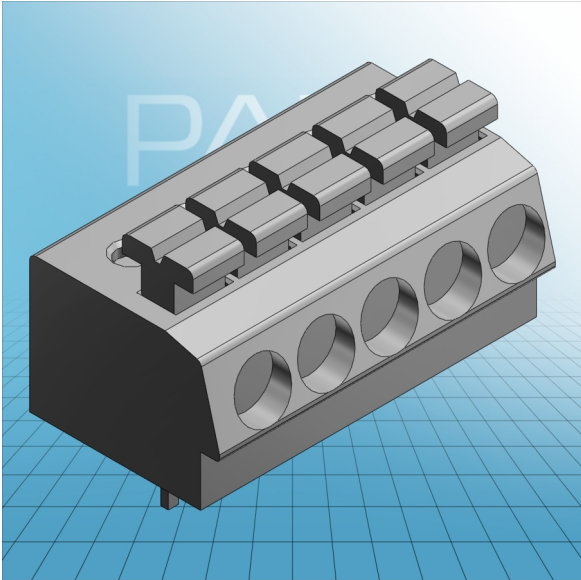

**1-CONDUCTOR PCB TERMINAL
STRIP 2 SOLDER PINS / POLES
STAGGERED PIN SPACING 5 MM / 0.
197 IN WITH PUSH BOTTONS
804-102 TO 804-116**

ITEM-NO. (ITEM-NO.)	804-105
Cross section1 (Cross section / mm²)	0.25 - 2.5
Cross section2 (Cross section / AWG)	20 - 12
Strip length (Strip length / mm)	10 - 11
Measured voltage (Measured voltage / V)	320
Measured shock voltage (Measured shock voltage / kV)	4
Pollution degree (Pollution degree)	2
Current intensity (Current intensity / A)	24
RM (PIN SPACING / mm)	5
P (NO. OF POLES)	5
Height (Height / mm)	14.4
Width (Width / mm)	26.5
Depth (Depth / mm)	15
No. of connection Points (No. of connection Points)	5
No. of potentials (No. of potentials)	5
COLOR (COLOR)	grau
Comment (Comment)	L = (No. of poles x Pin Spacing) + 1,5 mm
Dimensions (Dimensions)	1 +0,1 mm