

Display Elektronik GmbH

# DATA SHEET

***TFT MODULE***

**DEM 800480Q TMH-PW-N  
(C-TOUCH)**

**5,0“ TFT + PCT**

**Product Specification**

**Ver.: 0**

**11.09.2015**

**Revision History**

<b>VERSION</b>	<b>DATE</b>	<b>REVISED PAGE NO.</b>	<b>Note</b>
0	11.09.2015	-	First Issue

# **Contents**

1. General Specification
2. Interface
3. Contour Drawing
4. Absolute Maximum Ratings
5. Electrical Characteristics
6. Optical Characteristics
7. Reliability
8. Touch Panel Information

## **1. General Specifications**

- Size: 5.0 Inch
- Dot Matrix: 800 x (RGB) x 480 dots
- Module Dimension: 120.70 x 75.80 x 4.58 mm
- Active Area: 108.00 x 64.80 mm
- Dot Pitch: 0.045 x 0.135 mm
- LCD Type: TFT, Normally White, Transmissive
- 24-Bit-RGB-Interface
- View Direction: 12 o'clock
- Gray Scale Inversion Direction: 6 o'clock
- Backlight Type: LED, Lightguide, Normally White
- With /Without TP: With Projective Capacitive Touch
- Surface: Glare (Touch)

\*Color tone slight changed by temperature and driving voltage.

## 2. Interface

### 2.1. LCM PIN Definition

FPC connector is used for electronics interface. The recommended model is FH19SC-40S-0.5SH (05) manufactured by HIROSE.

No.	Symbol	I/O	Function
1	VLED-	P	Power for LED backlight cathode
2	VLED+	P	Power for LED backlight anode
3	GND	P	Power ground
4	VDD	P	Power voltage
5	R0	I	Red data (LSB)
6	R1	I	Red data
7	R2	I	Red data
8	R3	I	Red data
9	R4	I	Red data
10	R5	I	Red data
11	R6	I	Red data
12	R7	I	Red data (MSB)
13	G0	I	Green data (LSB)
14	G1	I	Green data
15	G2	I	Green data
16	G3	I	Green data
17	G4	I	Green data
18	G5	I	Green data
19	G6	I	Green data
20	G7	I	Green data (MSB)
21	B0	I	Blue data (LSB)
22	B1	I	Blue data
23	B2	I	Blue data
24	B3	I	Blue data
25	B4	I	Blue data
26	B5	I	Blue data
27	B6	I	Blue data
28	B7	I	Blue data (MSB)
29	GND	P	Power ground
30	DCLK	I	Pixel clock
31	DISP	I	Display on/ off
32	HSYNC	I	Horizontal sync signal
33	VSYNC	I	Vertical sync signal
34	DE	I	Data enable
35	NC	-	No connect
36	GND	P	Power ground

37	NC	-	No connect
38	NC	-	No connect
39	NC	-	No connect
40	NC	-	No connect

Note: I: input, O: output t, P: Power

## 2.2. CTP PIN Definition

Pin	Symbol	Function	Remark
1	VSS	Ground for analog circuit	
2	VDDT	Power Supply : +3.0V	
3	SCL	I2C clock input	
4	NC	No connect	
5	SDA	I2C data input and output	
6	NC	No connect	
7	/RST	External Reset, Low is active	
8	/WAKE	External interrupt from the host	
9	/INT	External interrupt to the host	
10	VSS	Ground for analog circuit	

### 3. Counter Drawing

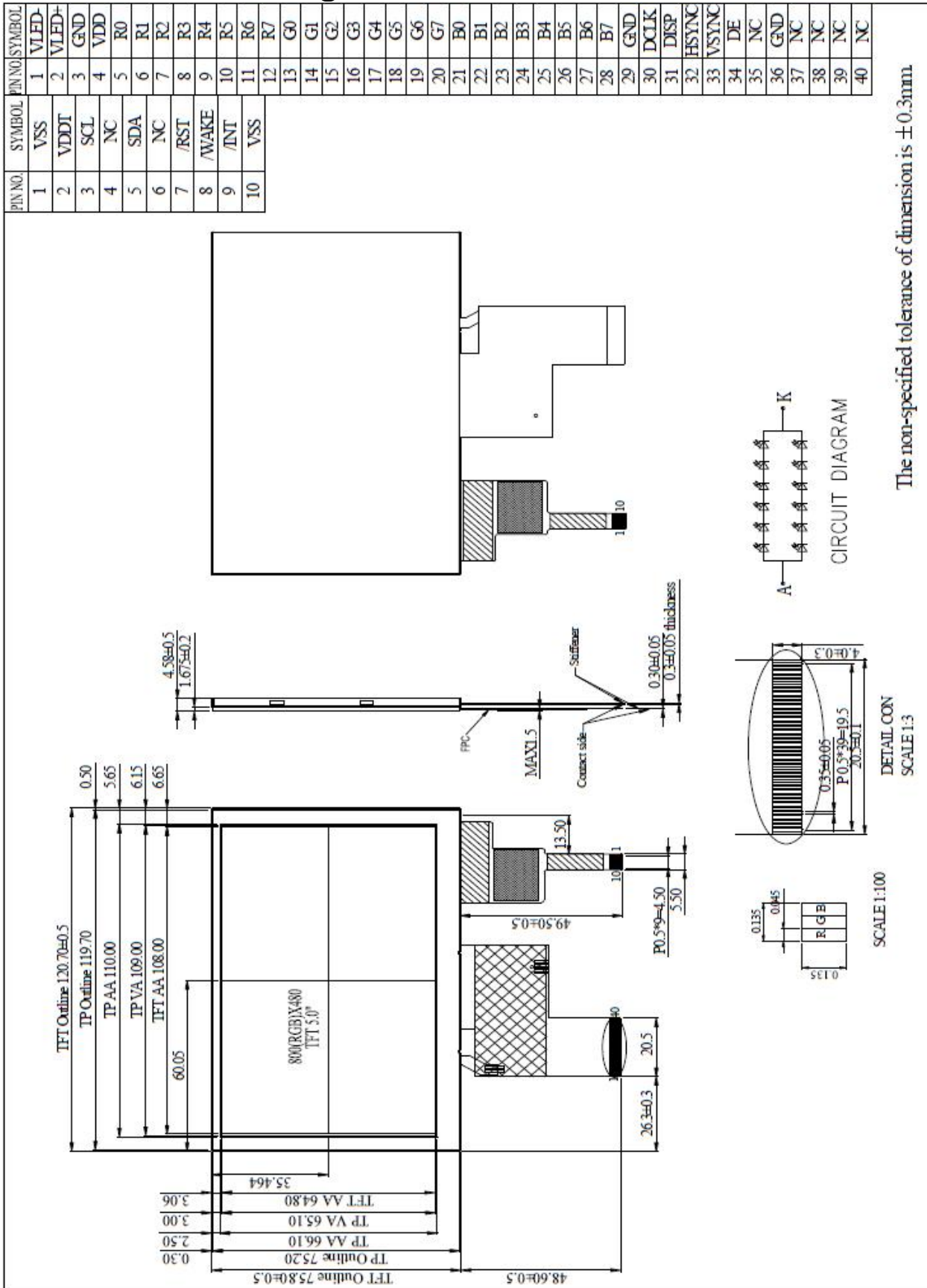

### 4. Absolute Maximum Ratings

Item	Symbol	Min	Typ	Max	Unit
Operating Temperature	T <sub>OP</sub>	-20	—	+70	°C
Storage Temperature	T <sub>ST</sub>	-30	—	+80	°C

Note: Device is subject to be damaged permanently if stresses beyond those absolute maximum ratings listed above

- Temp.  $\leq 60^{\circ}\text{C}$ , 90% RH MAX. Temp.  $> 60^{\circ}\text{C}$ , Absolute humidity shall be less than 90% RH at  $60^{\circ}\text{C}$

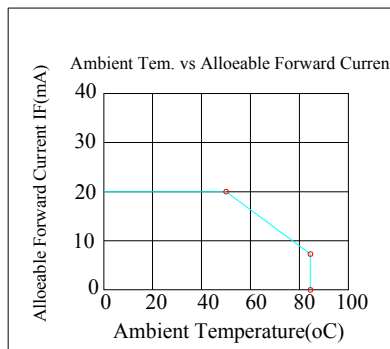



## 5. Electrical Characteristics

### 5.1. Typical Operation Conditions

Item	Symbol	Values			Unit	Remark
		Min.	Typ	Max.		
Power Voltage	VDD	3.0	3.3	3.6	V	Note 2
Current for Driver	IVDD	-	17	25	mA	
Input Logic High Voltage	VIH	0.8 VDD	-	VDD	V	Note 3
Input Logic Low Voltage	VIL	0	-	0.2 VDD	V	

### 5.2. Backlight driving conditions (12 White Chips)

Parameter	Symbol	Min.	Typ.	Max.	Unit	Note
Supply Voltage of White LED Backlight	VL	17.4	19.8	21	V	Note 1
Curt for LED Backlight	IL	30	40	50	mA	
Luminance (on the module surface, BM-7)		400	450	-	cd/m <sup>2</sup>	
LED Lifetime	-	20,000	-	-	Hr	Note 2

Note 1: The LED Supply Voltage is defined by the number of LED at Ta=25 °C and L =40mA.

Note 2: The “LED life time” is defined as the module brightness decrease to 50% original brightness at Ta=25 °C and IL =40mA. The LED lifetime could be decreased if operating IL is larger than 40mA.

### LED CIRCUIT

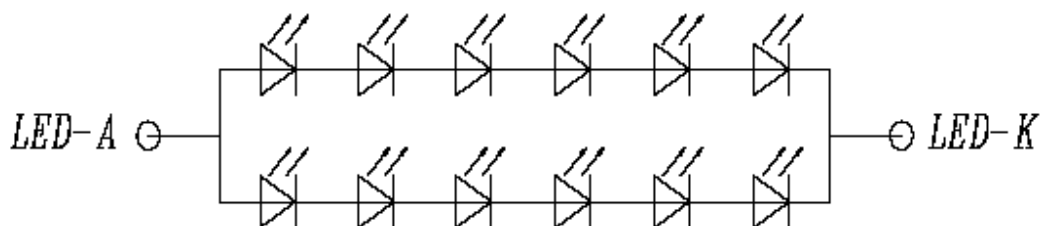

**5.3. Power Sequence**

To prevent the device damage from latch up, the power ON/OFF sequence shown below must be followed.

Power ON: VDD, DGND\_ VDDA, AGND \_ V1 to V14

Power OFF: V1 to V14 \_ VDDA, AGND\_ VDD, DGND

In order to prevent ILI6122 from power ON reset fail, the rising time (tPOR) of the digital power supply VDD should be maintained within given specifications. The power ON/OFF timing sequence is illustrated as below:

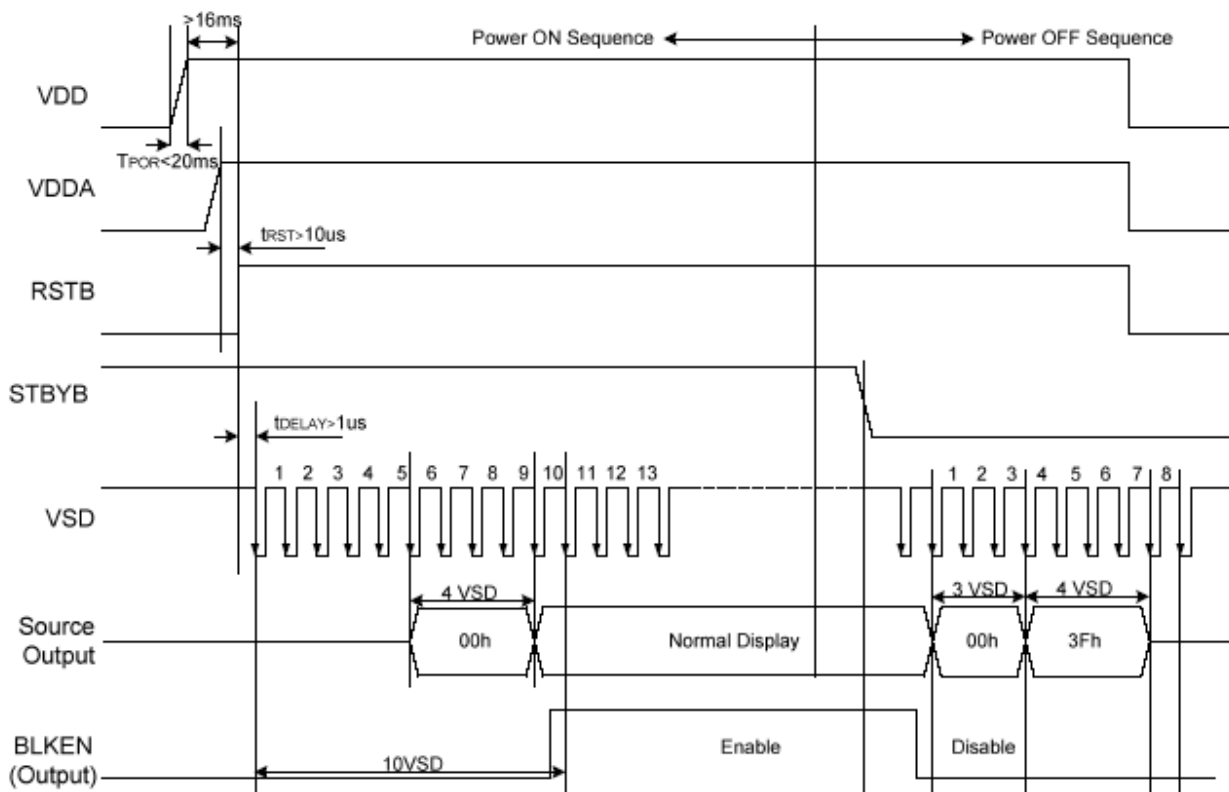

Note: For prevent anormal operation, tRST must be longer than 10us during Power ON sequence.

**5.4. Timing Characteristic**

AC Electrical Characteristics

Parameter	Symbol	Spec			Unit	Conditions
		Min.	Typ.	Max.		
VDD Power ON slew rate	tPOR	--	--	20	ms	0V ~ 0.9VDD
RSTB pulse width	tRST	10	--	--	us	CLKIN=50MHz
CLKIN cycle time	tCPH	20	--	--	ns	
CLKIN pulse duty	tCWH	40	50	60	%	
VSD setup time	tVST	8	--	--	ns	
VSD hold time	tVHD	8	--	--	ns	
HSD setup time	tHST	8	--	--	ns	
HSD hold time	tHHD	8	--	--	ns	
Data setup time	tDST	8	--	--	ns	D0[7:0], D1[7:0], D2[7:0] to CLKIN
Data hold time	tDHD	8	--	--	ns	D0[7:0], D1[7:0], D2[7:0] to CLKIN
DE setup time	tEST	8	--	--	ns	
DE hold time	tEHD	8	--	--	ns	
Output stable time	tSST	--	--	6	us	10% to 90% target voltage. CL=120pF, R=10KW
CLKIN frequency	fCLK	--	40	50	MHz	VDD=3.0 ~ 3.6V
CLKIN cycle time	tCLK	20	25	--	ns	
CLKIN pulse duty	tCWH	40	50	60	%	TCLK
Time from HSD to Source output	tHSO	--	20	--	CLKIN	
Time from HSD to LD	tHLD	--	20	--	CLKIN	Note (2)
Time from HSD to STV	tHSTV	--	2	--	CLKIN	
Time from HSD to CKV	tHCKV	--	20	--	CLKIN	
Time from HSD to OEV	tHOEV	--	4	--	CLKIN	
LD pulse width	tWLD	--	10	--	CLKIN	Note (2)
CKV pulse width	tWCKV	--	66	--	CLKIN	
OEV pulse width	tWOEV	--	74	--	CLKIN	

Note: (1) VDD=3.0 ~ 3.6V, VDDA=6.5~13.5V, DGND=AGND=0V, Ta=-20~+85 □

(2) The contents of the data register are transferred to the latch circuit at the rising edge of LD. Then the gray scale voltage is output from the device at the falling edge of LD.

(3) Output loading condition :

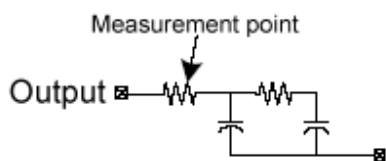

**DE Mode (MODE='1')**

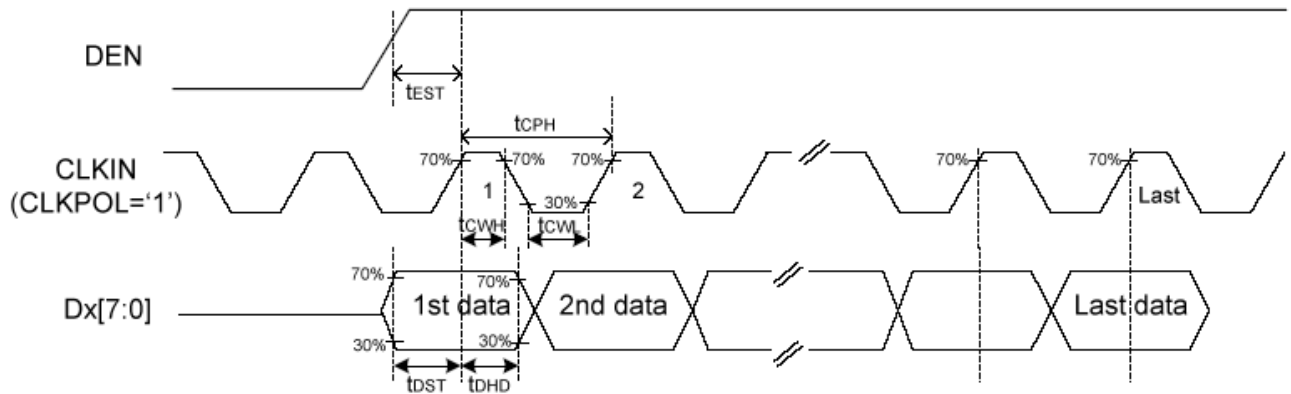

**Source Output timing Diagram (Cascade)**

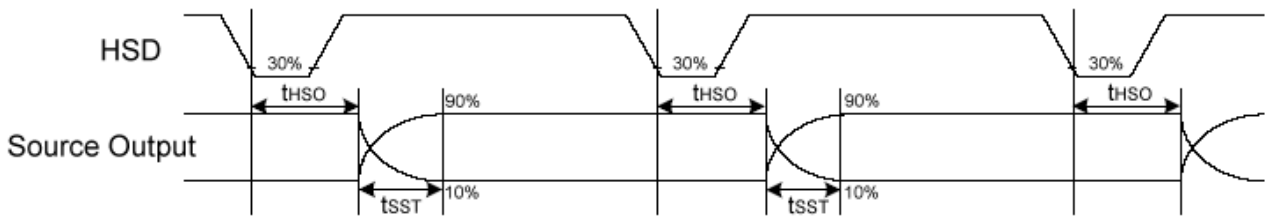

**SYNC Mode (MODE='0')**

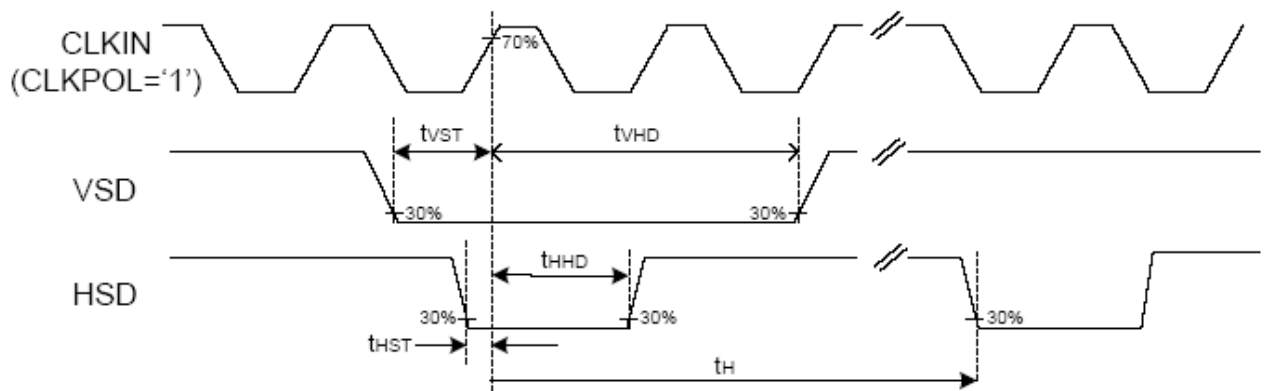

**Timing**

<b>Horizontal Input Timing</b>							
Parameter		Symbol	Value			Unit	
			Min.	Typ.	Max.		
Horizontal display area		tHD	--	800	--	CLKIN	
CLKIN frequency		fCLK	--	33.3	50	MHz	
1 Horizontal line period		tH	862	1056	1200	CLKIN	
HSD pulse width	Min.	tHPW	--	1	--	CLKIN	
	Typ.		--	--	--	CLKIN	
	Max.		--	40	--	CLKIN	
HSD back porch		SYNC	tHBP	46	46	46	CLKIN
HSD front porch		SYNC	tHFP	16	210	354	CLKIN

<b>Vertical Input Timing</b>						
Parameter		Symbol	Value			Unit
			Min.	Typ.	Max.	
Vertical display area		tVD	--	480	--	HSD
VSD period time		tV	510	525	650	HSD
VSD pulse width		tVPW	1	--	20	HSD
VSD back porch		tVBP	23	23	23	HSD
VSD front porch		tVFP	7	22	147	HSD

Parameter	Symbol	Spec			Unit	Conditions
		Min.	Typ.	Max.		
SCL period	TCK	60	--	--	ns	
SCL high width	TCKH	30	--	--	ns	
SCL low width	TCKL	30	--	--	ns	
Data setup time	TSU1	12	--	--	ns	
Data hold time	THD1	12	--	--	ns	
CSX to SCL setup time	TCS	20	--	--	ns	
CSX to SDA hold time	TCE	20	--	--	ns	
CSX high pulse width	TCD	50	--	--	ns	

Data Input Format

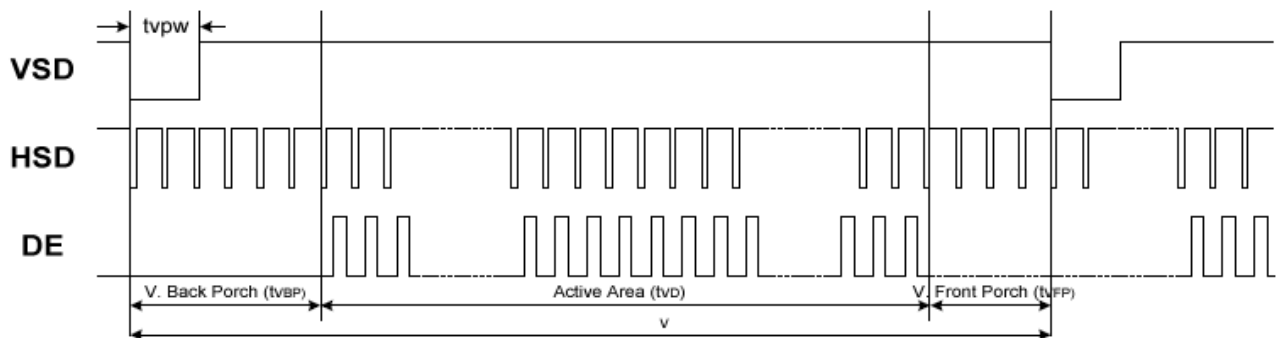
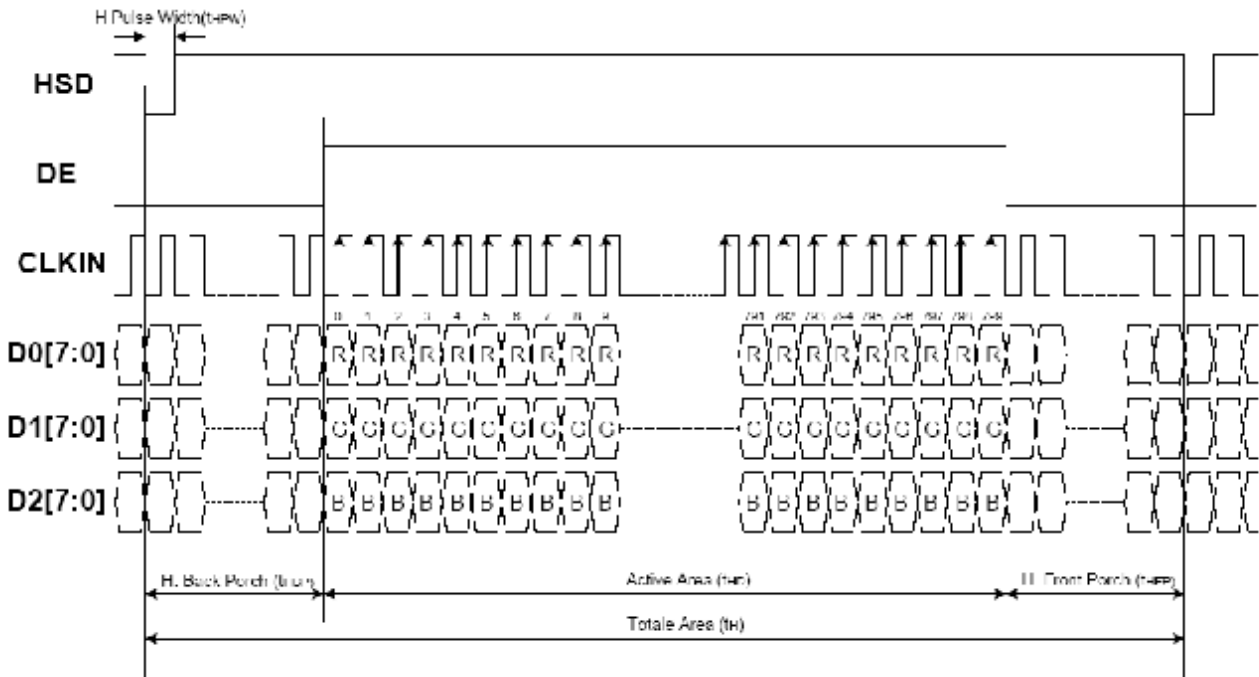

SPI Timing

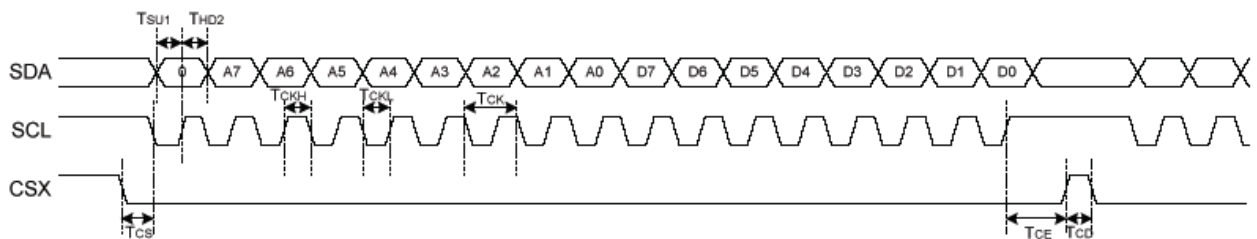

## 6. Optical Characteristics

Item		Symbol	Condition.	Min	Typ.	Max.	Unit	Remark
Response Time		Tr	$\theta=0^\circ$ 、 $\Phi=0^\circ$	-	10	20	.ms	Note 3,5
		Tf		-	10	20	.ms	
Contrast Ratio		CR	At optimized viewing angle	500	700	-	-	Note 4,5
Color Chromaticity	White	Wx	$\theta=0^\circ$ 、 $\Phi=0^\circ$	0.26	0.31	0.36		Note 2,6,7
		Wy		0.28	0.33	0.38		
Viewing Angle	Hor.	$\Theta_R$	$CR \geq 10$	60	70	-	Deg.	Note 1
		$\Theta_L$		60	70	-		
	Ver.	$\Phi_T$		40	50	-		
		$\Phi_B$		60	70	-		
Brightness		-	-	300	350	-	cd/m <sup>2</sup>	Center of display

Ta=25±2°C

Note 1: Definition of viewing angle range

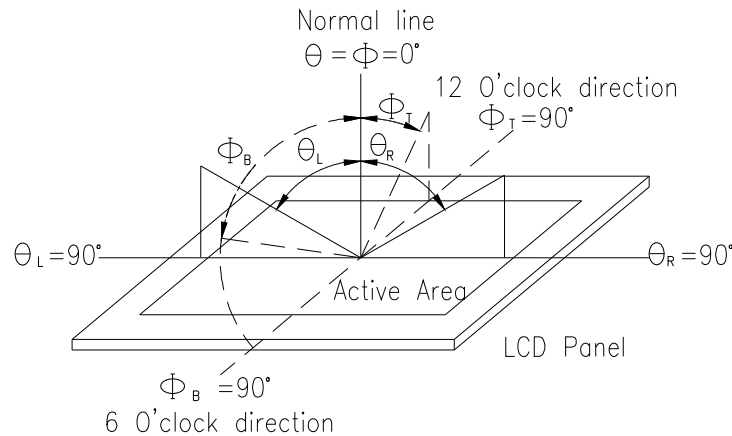
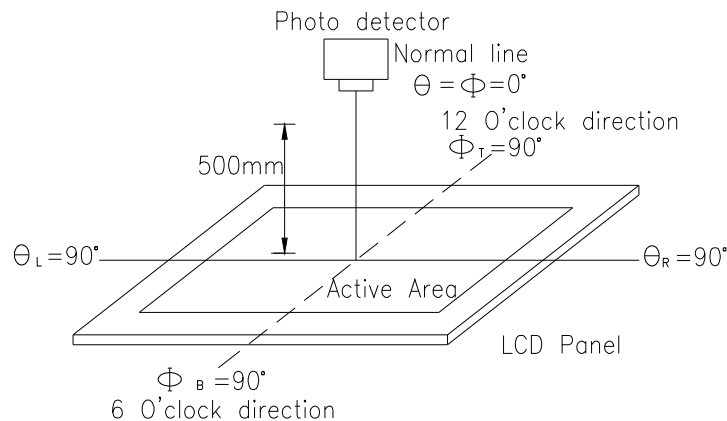

Fig. 6.1. Definition of viewing angle

Note 2: Test equipment setup:

After stabilizing and leaving the panel alone at a driven temperature for 10 minutes, the measurement should be executed. Measurement should be executed in a stable, windless, and dark room. Optical specifications are measured by Topcon BM-7or BM-5 luminance meter 1.0° field of view at a distance of 50cm and normal direction.



**Fig. 6.2. Optical measurement system setup**

**Note 3: Definition of Response time:**

The response time is defined as the LCD optical switching time interval between “White” state and “Black” state. Rise time,  $T_r$ , is the time between photo detector output intensity changed from 90% to 10%. And fall time,  $T_f$ , is the time between photo detector output intensity changed from 10% to 90%

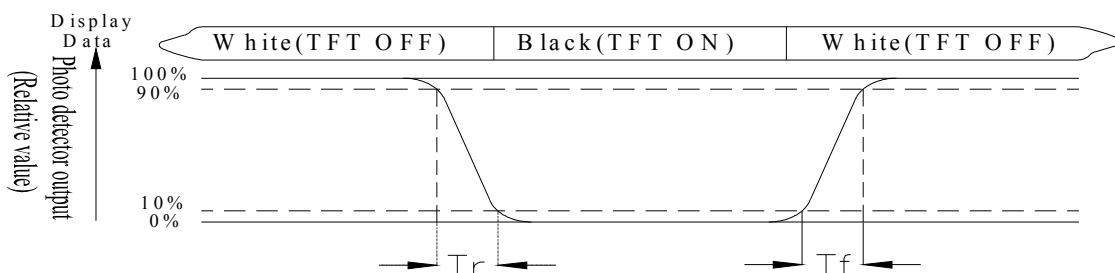

**Note 4: Definition of contrast ratio:**

The contrast ratio is defined as the following expression.

$$\text{Contrast ratio (CR)} = \frac{\text{Luminance measured when LCD on the "White" state}}{\text{Luminance measured when LCD on the "Black" state}}$$

**Note 5: White  $V_i = V_{i50} \pm 1.5V$**

**Black  $V_i = V_{i50} \pm 2.0V$**

“±” means that the analog input signal swings in phase with VCOM signal.

“±” means that the analog input signal swings out of phase with VCOM signal.

The 100% transmission is defined as the transmission of LCD panel when all the input terminals of module are electrically opened.

**Note 6: Definition of color chromaticity (CIE 1931)**

Color coordinates measured at the center point of LCD

**Note 7: Measured at the center area of the panel when all the input terminals of LCD panel are electrically opened.**



## 7. Reliability

Content of Reliability Test (Wide temperature, -20°C~70°C)

Environmental Test			
Test Item	Content of Test	Test Condition	Note
High Temperature storage	Endurance test applying the high storage temperature for a long time.	80°C 200hrs	2
Low Temperature storage	Endurance test applying the low storage temperature for a long time.	-30°C 200hrs	1,2
High Temperature Operation	Endurance test applying the electric stress (Voltage & Current) and the thermal stress to the element for a long time.	70°C 200hrs	—
Low Temperature Operation	Endurance test applying the electric stress under low temperature for a long time.	-20°C 200hrs	1
High Temperature/ Humidity Operation	The module should be allowed to stand at 60%,90%RH max	60°C, 90%RH 96hrs	1,2
Thermal shock resistance	The sample should be allowed stand the following 10 cycles of operation  <div style="text-align: center;"> <p style="margin: 0;">-20°C    25°C    70°C</p> <p style="margin: 0;">30min    5min    30min</p> <p style="margin: 0;">1 cycle</p> </div>	-20°C/70°C 10 cycles	—
Vibration test	Endurance test applying the vibration during transportation and using.	Total fixed amplitude : 15mm Vibration Frequency : 10~55Hz One cycle 60 seconds to 3 directions of X,Y,Z for Each 15 minutes	3
Static electricity test	Endurance test applying the electric stress to the terminal.	VS=800V, RS=1.5kΩ CS=100pF 1 time	—

Note1: No dew condensation to be observed.

Note2: The function test shall be conducted after 4 hours storage at the normal Temperature and humidity after remove from the test chamber.

Note3: The packing have to including into the vibration testing.

# 8. Touch Panel Information

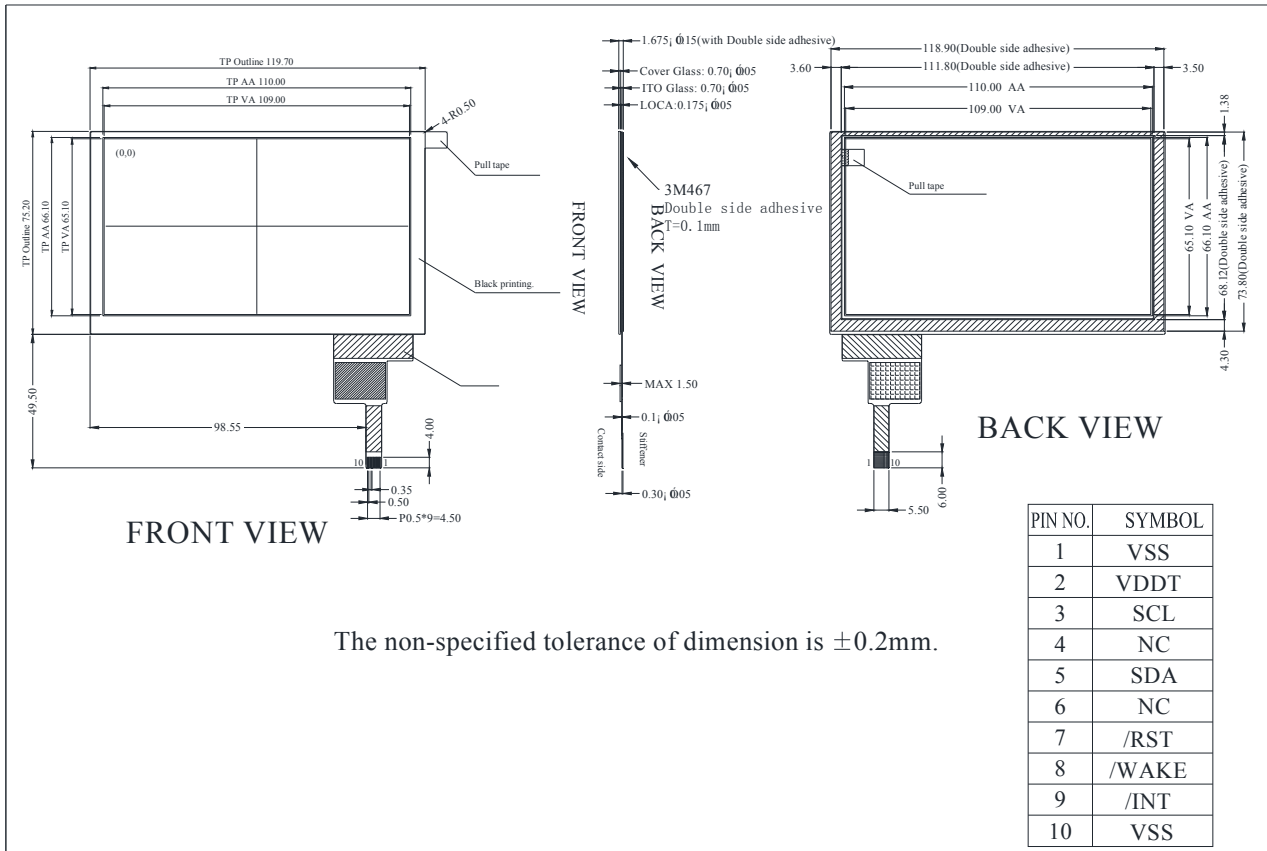

8.1. Capacitive Touch-Panel I2C-Timing:

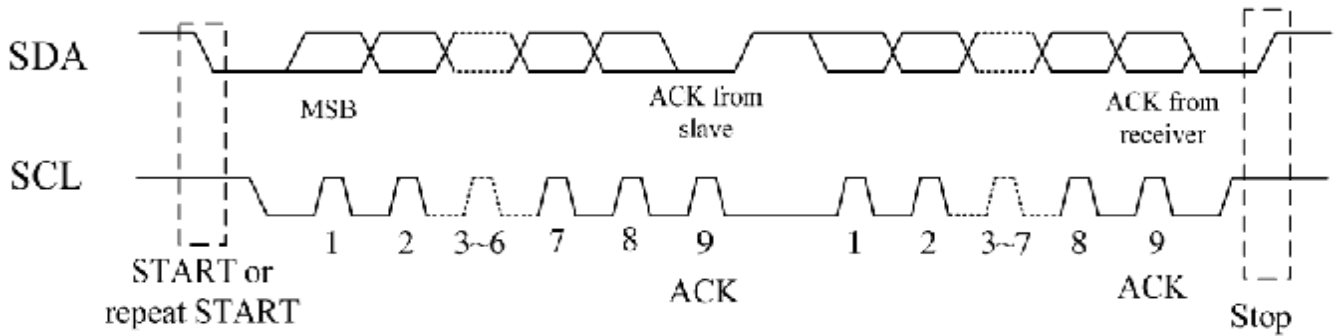

I2C Serial Data Transfer Format

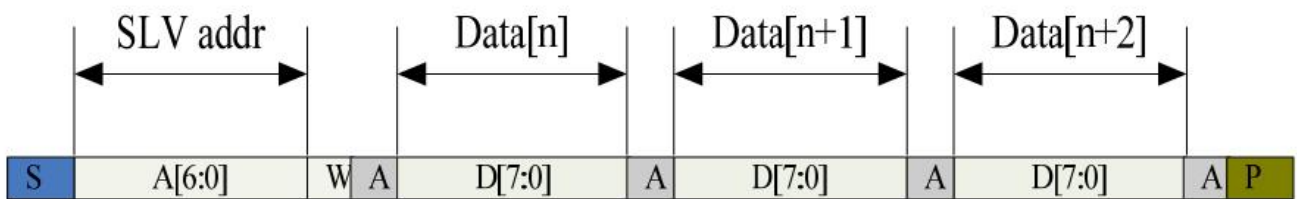

I2C master write, slave read

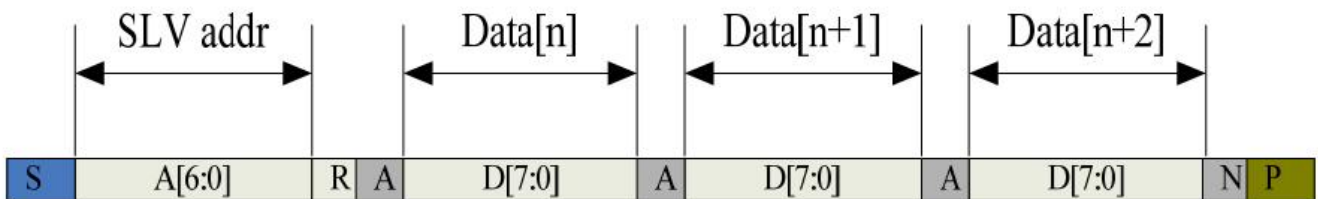

I2C master read, slave write

Mnemonics	Description
S	12C Start or 12C Restart
A[6:0]	Slave address A[6:4]:3'b011 A[3:0]:data bits are identical to those of 12CCON[7:4]register
W	1'b0:Write
R	1'b1:Read
A(N)	ACK(NACK)
P	STOP :the indication of the end of a packet(if this bit is missing, S will indicate the end of the current packet and beginning of the next packet)

Lists the meanings of the mnemonics used in the above figures

Parameter	Unit	Min	Max
SCL frequency	KHz	0	400
Bus free time between a STOP and START condition	us	4.7	\
Hold time (repeated) START condition	us	4.0	\
Data setup time	ns	250	\
Setup time for a repeated START condition	us	4.7	\
Setup time for STOP condition	us	4.0	\

Interface Timing Characteristics

AS FOR STANDARD CTPM, HOST NEED TO USE BOTH INTERRUPT CONTROL SIGNAL AND SERIAL DATA INTERFACE TO GET THE TOUCH DATA.

HERE IS THE TIMING TO GET TOUCH DATA.

8.2. WRITE BYTES TO I2C SLAVE

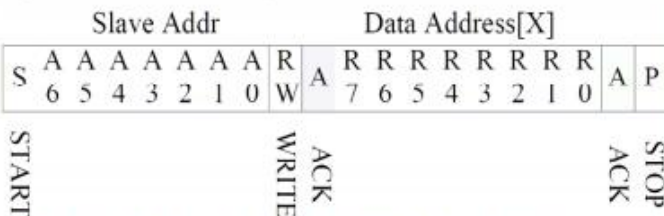
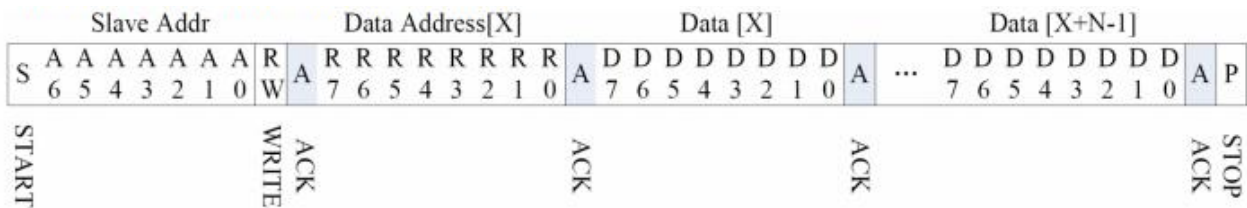

READ X BYTES FROM I2C SLAVE

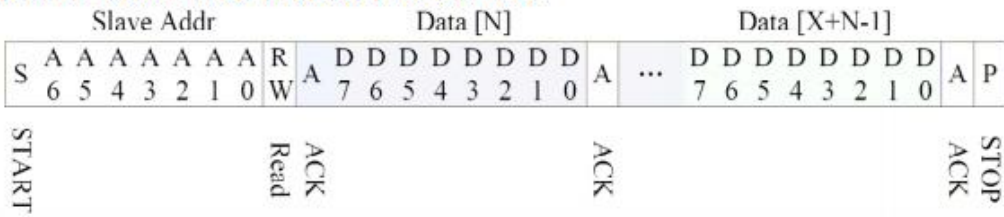

AS FOR STANDARD CTPM, HOST NEED TO USE BOTH INTERRUPT CONTROL SIGNAL AND SERIAL DATA INTERFACE TO GET THE TOUCH DATA, HERE IS THE TIMING TO GET TOUCH DATA.

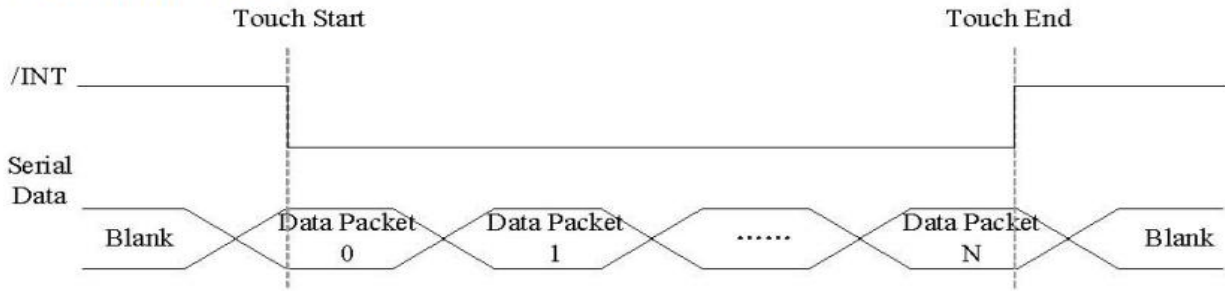

Address: 0x38

**TOUCH DATA READ PROTOCOL**

NAME	VALUE	DESCRIPTION
START CH	0X00	START COMMAND FOR CTPM TOUCH DATA PACKET,HOST MUST SEND CTPM A START CH COMMAND BEFORE READ TOUCH DATA
1st READ BYTE ~ LAST READ BYTE		TOUCH DATA PACKET SENT BY CTPM,EACH BYTE HAS 8-BIT DATA ,A TOUCH DATA PACKET CONSISTS OF N BYTE

A DATA PACKET STARTS WITH A HEADER AND ENDS WITH CRC CODE,AS FOR 5 POINTS DATA PACKET,THE LENGTH OF THE PACKET IS ALWAYS 26 BYTES IN SPIE OF ACTUAL TOUCH POINTS.

Address	Name	Bit7	Bit6	Bit5	Bit4	Bit3	Bit2	Bit1	Bit0	Host Access
00h	Devide__Mode		Device Model[2:0]							RW
01h	Gest__ID	Gesture ID[7:0]								R
02h	TD__Status					Number of touch points[3:0]			R	
03h	Touch1__XH	1 <sup>st</sup> Event Flag		1 <sup>st</sup> Touch X Position[11:8]					R	
04h	Touch1__XL	1 <sup>st</sup> Touch X Position[7:0]								R
05h	Touch1__YH	1 <sup>st</sup> Touch ID[3:0]			1 <sup>st</sup> Touch Y Position[11:8]					R

06h	Touch1__YL	1 <sup>st</sup> Touch Y Position[7:0]			R
09h	Touch2__XH	2 <sup>nd</sup> Event Flag		2 <sup>nd</sup> Touch X Position[11:8]	R
0Ah	Touch2__XL	2 <sup>nd</sup> Touch X Position[7:0]			R
0Bh	Touch2__YH	2nd Touch ID[3:0]		2ndTouch Y Position[11:8]	R
0Ch	Touch2__YL	2nd Touch Y Position[7:0]			R

0Fh	Touch3__XH	3rdEvent Flag		3rdTouch X Position[11:8]	R
10h	Touch3__XL	3rd Touch X Position[7:0]			R
11h	Touch3__YH	3rdTouch ID[3:0]		3rdTouch Y Position[11:8]	R
12h	Touch3__YL	3rd Touch Y Position[7:0]			R
15h	Touch4__XH	4thEvent Flag		4thTouch X Position[11:8]	R
16h	Touch4__XL	4th Touch X Position[7:0]			R
17h	Touch4__YH	4thTouch ID[3:0]		4thTouch Y Position[11:8]	R
18h	Touch4__YL	4th Touch Y Position[7:0]			R
1Bh	Touch5__XH	5thEvent Flag		5thTouch X Position[11:8]	R
1Ch	Touch5__XL	5th Touch X Position[7:0]			R
1Dh	Touch5__YH	5thTouch ID[3:0]		5thTouch Y Position[11:8]	R
1Eh	Touch5__YL	5th Touch Y Position[7:0]			R