

Data sheet | Item number: 736-108

Double-deck PCB terminal block; 2.5 mm<sup>2</sup>; Pin spacing 5 mm; 2 x 8-pole;  
CAGE CLAMP®

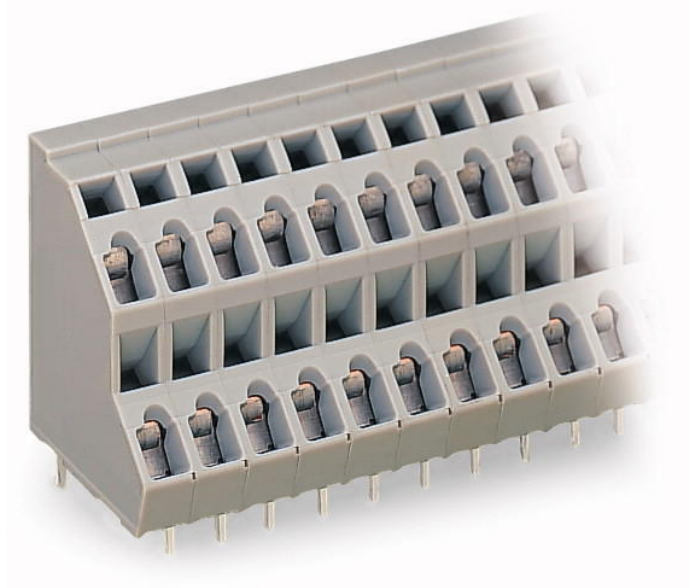

[www.wago.com/736-108](http://www.wago.com/736-108)



**Strombelastbarkeitskurve**  
Rastermaß 5 mm / Leiterquerschnitt 2,5 mm<sup>2</sup> „f“  
In Anlehnung an: EN 60512-5-2 / Reduktionsfaktor 1

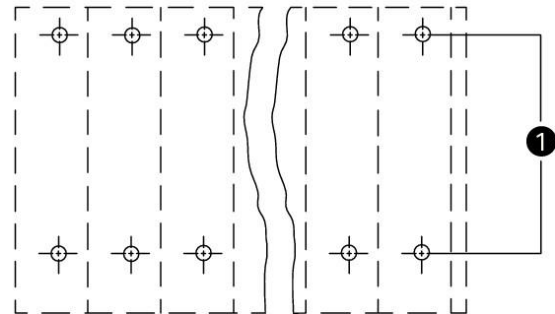
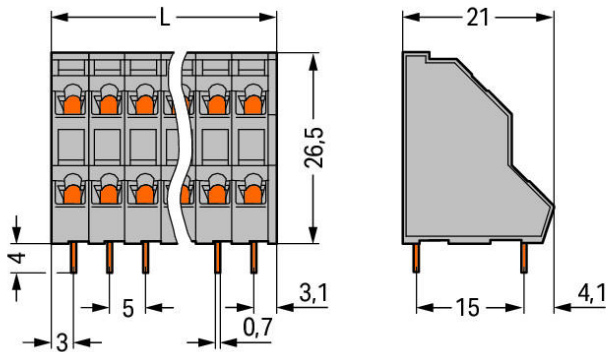
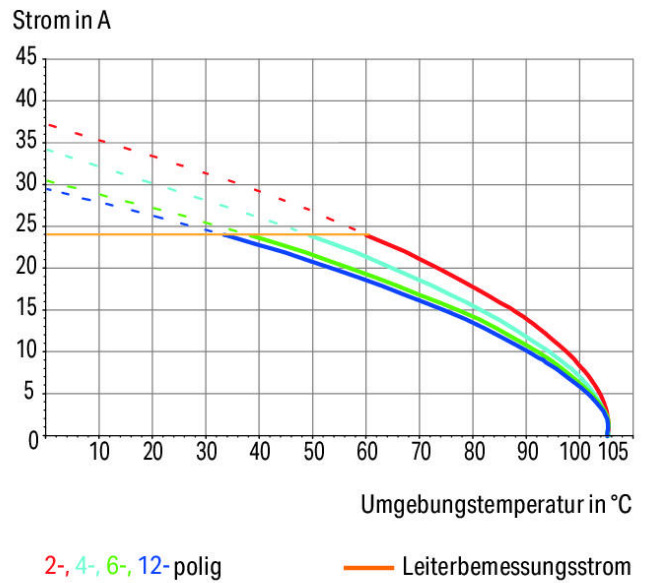

(1) Solder pins in a row

Voltage rating between adjacent poles:

320 V / 4 kV (III / 3)

320 V / 4 kV (III / 2)

$L = (\text{pole no.} \times \text{pin spacing}) + 1 \text{ mm}$

630 V / 4 kV (II / 2)

## Item description

- Terminal strips with screwdriver-actuated CAGE CLAMP®
- High-density, double-deck design for space-efficient wiring of multiple conductors in confined areas
- Custom inkjet marking for all termination levels
- Terminal strips with commoning strips for distribution of potential

Other versions (or variants) can be requested from WAGO Sales or configured at <https://configurator.wago.com/>. Direct marking, Mixed-color terminal strips, Other colors, Other pole numbers

## Data

### Electrical data

#### Ratings per IEC/EN 60664-1

Ratings note	Between the modules
Rated voltage (III / 3)	250 V
Rated impulse voltage (III / 3)	4 kV
Rated voltage (III/2)	320 V
Rated impulse voltage (III / 2)	4 kV
Rated voltage (II / 2)	630 V
Rated impulse voltage (II / 2)	4 kV
Rated current	21 A
Ratings according to 2	IEC/EN 60664-1
Ratings note 2	Between the decks
Rated voltage (III / 3) 2	320 V
Rated impulse voltage (III / 3) 2	4 kV
Rated voltage (III / 2) 2	320 V
Rated impulse voltage (III / 2) 2	4 kV
Rated voltage (II / 2) 2	630 V
Rated impulse voltage (II / 2) 2	4 kV
Rated current (2)	21 A
Legend (ratings)	(III / 2) ≙ Overvoltage category III / Pollution degree 2

#### Approvals per UL 1059

Rated voltage UL (Use Group B)	300 V
Rated current UL (Use Group B)	10 A
Rated voltage UL (Use Group D)	300 V
Rated current UL (Use Group D)	10 A



## Approvals per CSA

Rated voltage CSA (Use Group B)	300 V
Rated current CSA (Use Group B)	10 A
Rated voltage CSA (Use Group D)	300 V
Rated current CSA (Use Group D)	10 A

## Connection data

Connection technology	CAGE CLAMP®
Actuation type	Operating tool
Solid conductor	0.08 ... 2.5 mm <sup>2</sup> / 28 ... 12 AWG
Fine-stranded conductor	0.08 ... 2.5 mm <sup>2</sup> / 28 ... 12 AWG
Fine-stranded conductor with ferrule with plastic collar	0.25 ... 1.5 mm <sup>2</sup>
Fine-stranded conductor with ferrule without plastic collar	0.25 ... 2.5 mm <sup>2</sup>
Strip length	5 ... 6 mm / 0.2 ... 0.24 Inch
Conductor entry angle to the PCB	45°
No. of poles	8
Total number of connection points	16
Total number of potentials	16
Number of connection types	1
Number of levels	2

## Geometrical Data

Pin spacing	5 mm (0.197 in)
Width	41 mm / 1.614 in
Height	30.5 mm / 1.201 in
Height from the surface	26.5 mm / 1.043 in
Depth	21 mm / 0.827 in
Solder pin length	4 mm
Solder pin dimensions	0.7 x 0.7 mm
Drilled hole diameter (tolerance)	1.3 <sup>(+0.1)</sup> mm

## PCB contact

PCB contact	THT
Solder pin arrangement	within the terminal block, in line
Number of solder pins per potential	1

## Material Data

Color	gray
Material group	I
Insulating material	Polyamide 66 (PA 66)
Flammability class per UL94	V0
Clamping spring material	Chrome nickel spring steel (CrNi)
Contact material	Electrolytic copper (Ecu)
Contact plating	tin-plated
Fire load	0.285 MJ
Weight	18.563 g





## Environmental Requirements

Limit temperature range	-60 ... 105 °C
-------------------------	----------------

## Commercial data

Country of origin	PL
GTIN	4044918913447
Customs Tariff No.	85369010000
Product Group	4 (Printed Circuit)

## Country specific Approvals

Logo	Approval	Certificate name
	CCA DEKRA Certification B.V.	2160584.37
	CCA DEKRA Certification B.V.	NTR NL-7143
	CCA DEKRA Certification B.V.	NTR NL-7307
	CSA DEKRA Certification B.V.	70049157

## Ship Approvals

Logo	Approval	Certificate name
	<b>DNV GL</b> Det Norske Veritas, Germanischer Lloyd	TAE000016Z

## UL-Approvals

Logo	Approval	Certificate name
	<b>cURus</b> Underwriters Laboratories Inc.	E45172, sec. 6

Subject to changes.