

## Technical Data Sheet

### Mini Top View LEDs

#### 65-21/T2C-FR1S2B17X/2T

#### Features

- White SMT package.
- Optical indicator.
- Wide viewing angle.
- Soldering methods: IR reflow soldering
- Available on tape and reel
- Pb-free
- The product itself will remain within RoHS compliant version.



#### Descriptions

The white LED which was fabricated using a blue LED and a phosphor, and the phosphor is excited by blue light and emits yellow fluorescence.

The mixture of blue light and yellow light results in a white emission.

#### Applications

- Optical indicators.
- Coupling into light guides.
- Backlighting (LCD, cellular phones, switches, keys, displays, illuminated advertising, general lighting).
- Coupling into light guides; Interior automotive lighting (e.g. dashboard backlighting, etc.).

#### Device Selection Guide

Chip	Emitted Color	Resin Color
Material		
InGaN	Pure White	Yellow Diffused

**Technical Data Sheet**

**Mini Top View LEDs**

**65-21/T2C-FR1S2B17X/2T**

**Package Outline Dimensions**

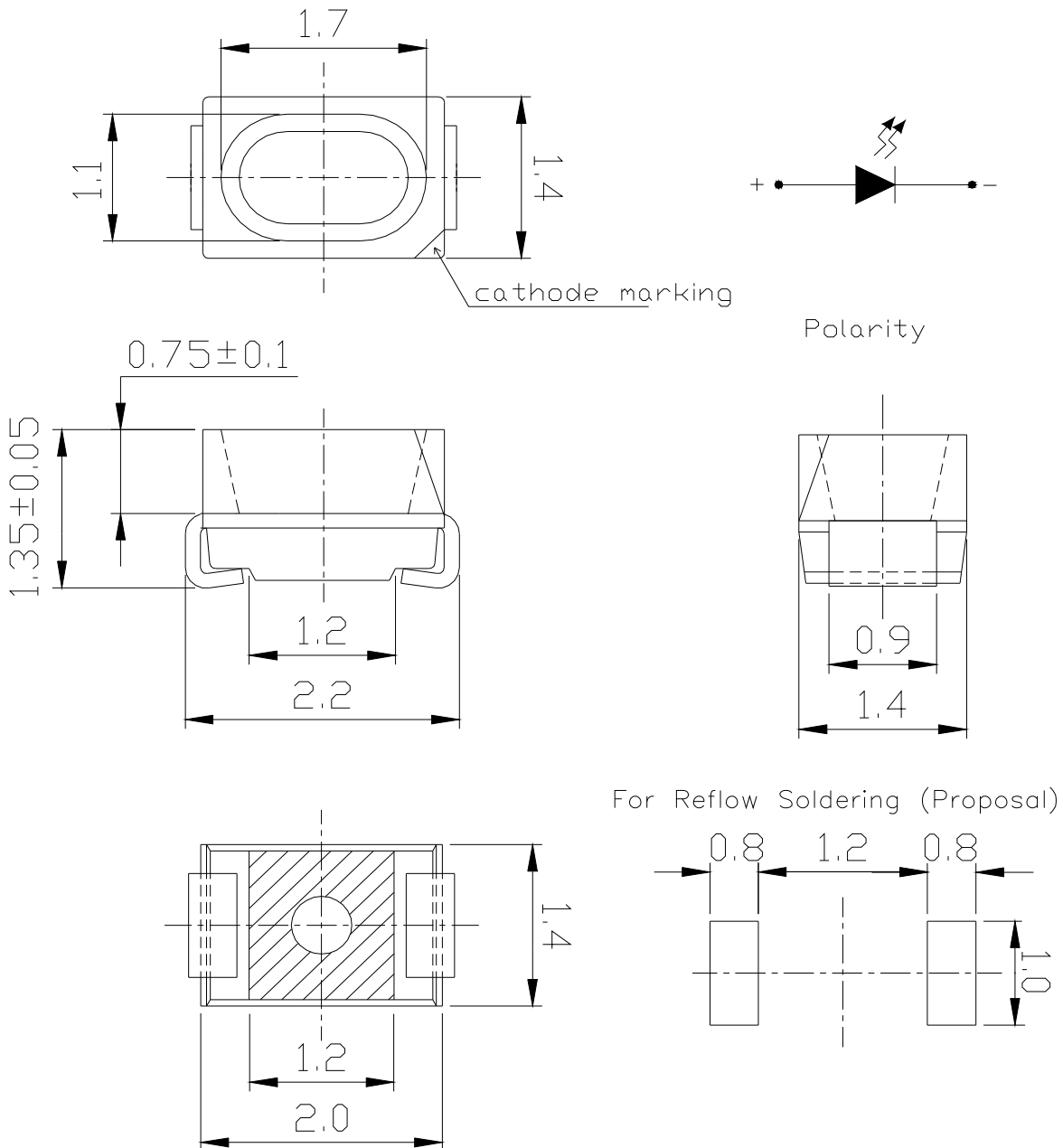

**Note:** Tolerance unless mentioned is ±0.1mm; Unit = mm

**Technical Data Sheet**

**Mini Top View LEDs**

**65-21/T2C-FR1S2B17X/2T**

**Absolute Maximum Ratings (Ta=25 )**

Parameter	Symbol	Rating	Unit
Reverse Voltage	V <sub>R</sub>	5	V
Forward Current	I <sub>F</sub>	30	mA
Power Dissipation	P <sub>d</sub>	100	mW
Peak Forward Current (Duty 1/10 @1KHz)	I <sub>FP</sub>	110	mA
Electrostatic Discharge (HBM)	ESD	1000	V
Operating Temperature	T <sub>opr</sub>	-40 ~ +85	
Storage Temperature	T <sub>stg</sub>	-40 ~ +90	
Soldering Temperature	T <sub>sol</sub>	Reflow Soldering : 260 Hand Soldering : 350	for 10 sec. for 3 sec.

**Electro-Optical Characteristics (Ta=25 )**

Parameter	Symbol	Min.	Typ.	Max.	Unit	Condition
Luminous Intensity	I <sub>v</sub>	112	-----	285	mcd	I <sub>F</sub> =2mA
Viewing Angle	2 1/2	-----	120	-----	deg	I <sub>F</sub> =2mA
Forward Voltage	V <sub>F</sub>	2.5	-----	3.5	V	I <sub>F</sub> =2mA
Reverse Current	I <sub>R</sub>	-----	-----	50	μ A	V <sub>R</sub> =5V

**Notes:**

1. Tolerance of Luminous Intensity: ±11%
2. Tolerance of Forward Voltage: ±0.1V

Technical Data Sheet

Mini Top View LEDs

65-21/T2C-FR1S2B17X/2T

**Bin Range of Luminous Intensity**

Bin Code	Min.	Max.	Unit	Condition
R1	112	140	mcd	I <sub>F</sub> =2mA
R2	140	180		
S1	180	225		
S2	225	285		

**Bin Range of Forward Voltage**

Group	Bin	Min.	Max.	Unit	Condition
B17	9	2.5	2.7	V	I <sub>F</sub> =2mA
	10	2.7	2.9		
	11	2.9	3.1		
	12	3.1	3.3		
	13	3.3	3.5		

**Notes:**

1. Tolerance of Luminous Intensity:  $\pm 11\%$
2. Tolerance of Forward Voltage:  $\pm 0.1V$

**Technical Data Sheet**

**Mini Top View LEDs**

**65-21/T2C-FR1S2B17X/2T**

**Bin Range of Chromaticity Coordinates**

**I<sub>F</sub>=20mA**

Group	Bin Code	CIE_x	CIE_y	Bin Code	CIE_x	CIE_y
F	B3	0.2870	0.2950	B5	0.2960	0.2760
		0.2830	0.3050		0.2870	0.2950
		0.3040	0.3300		0.3070	0.3150
		0.3070	0.3150		0.3110	0.2940
	B4	0.3070	0.3150	B6	0.3110	0.2940
		0.3040	0.3300		0.3070	0.3150
		0.3300	0.3600		0.3300	0.3390
		0.3300	0.3390		0.3300	0.3180

**Notes:** Tolerance of Chromaticity Coordinates : ±0.01

**The C.I.E. 1931 Chromaticity Diagram**

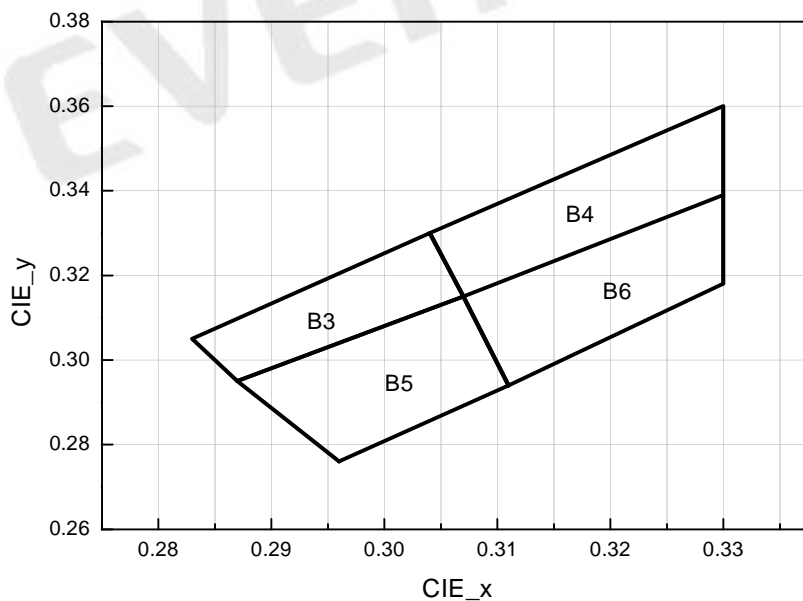

**Technical Data Sheet**

**Mini Top View LEDs**

**65-21/T2C-FR1S2B17X/2T**

**Typical Electro-Optical Characteristics Curves**

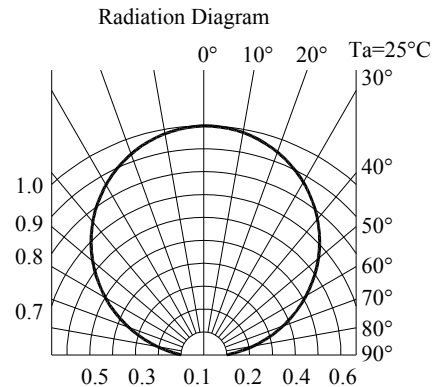
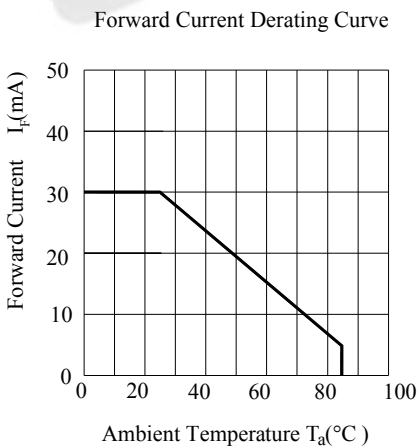
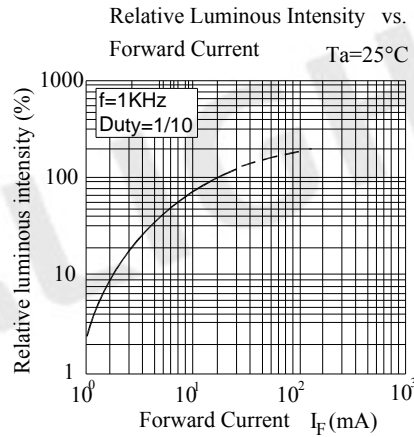
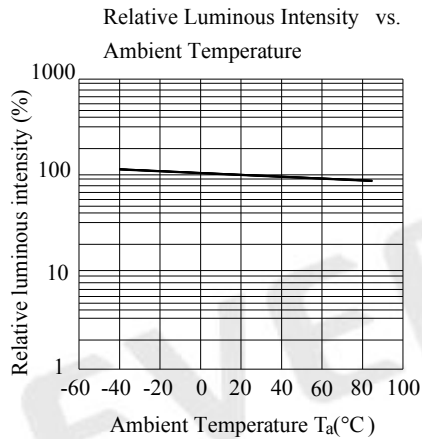
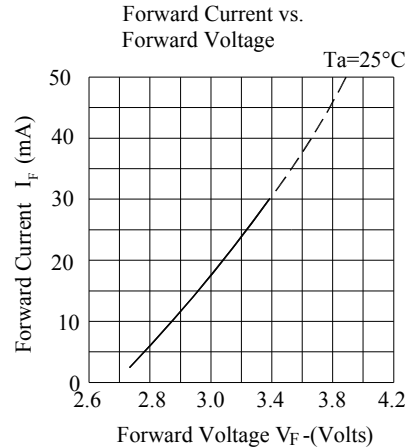
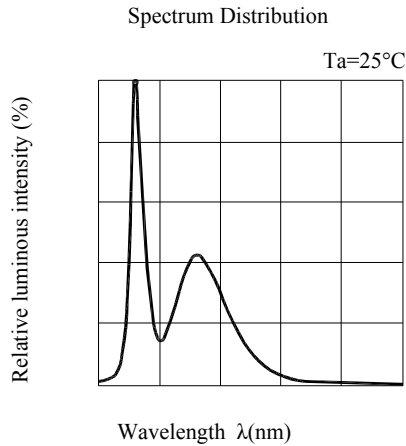

**Technical Data Sheet**

**Mini Top View LEDs**

**65-21/T2C-FR1S2B17X/2T**

**Label Explanation**

**CAT: Luminous Intensity Rank**

**HUE: Chromaticity Coordinates**

**REF: Forward Voltage Rank**

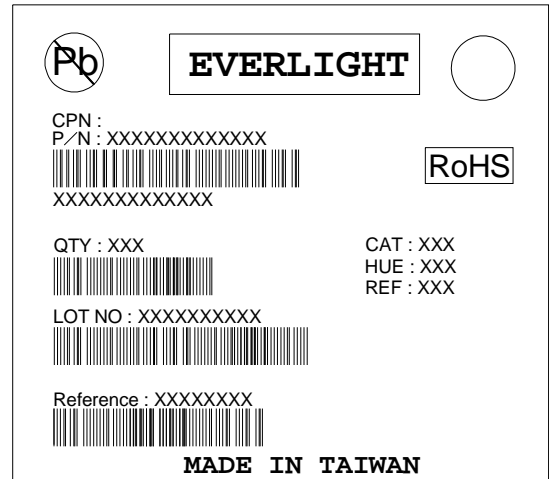

**Reel Dimensions**

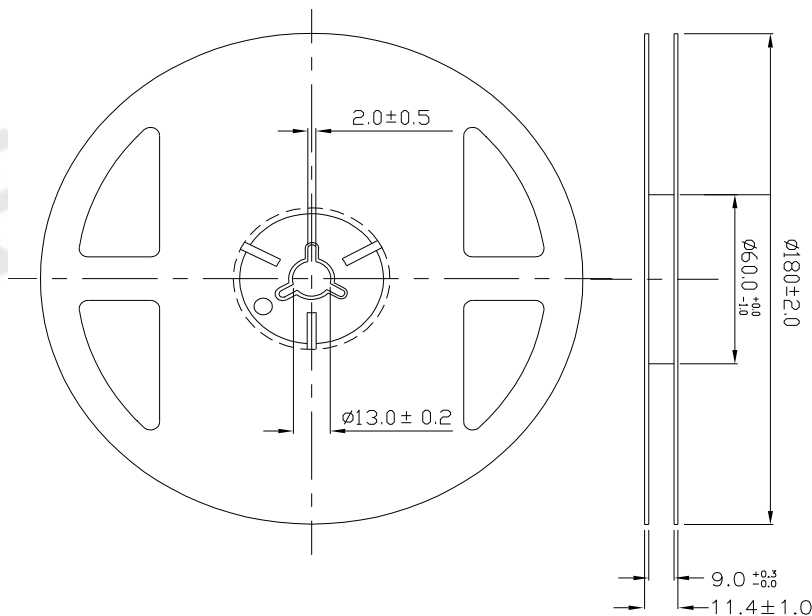

**Note:** Tolerance unless mentioned is  $\pm 0.1$ mm; Unit = mm

**Technical Data Sheet**

**Mini Top View LEDs**

**65-21/T2C-FR1S2B17X/2T**

**Carrier Tape Dimensions: Loaded Quantity 2000 pcs Per Reel.**

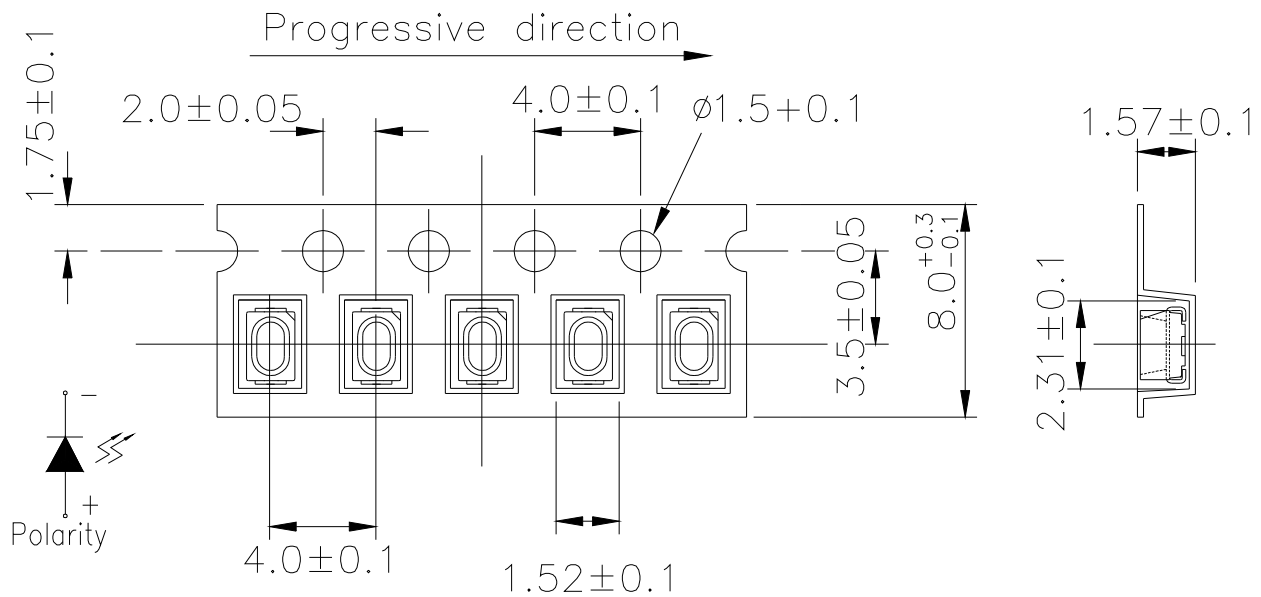

**Note:** Tolerance unless mentioned is  $\pm 0.1$ mm; Unit = mm

**Moisture Resistant Packaging**

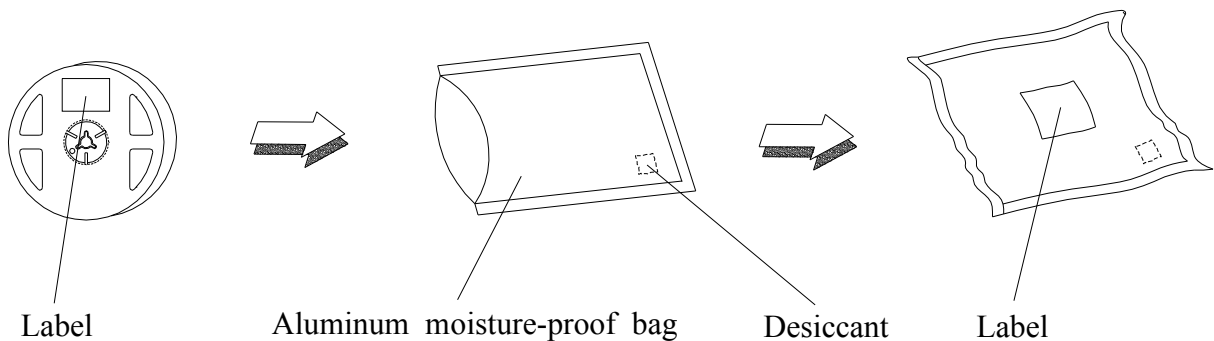



## Technical Data Sheet

### Mini Top View LEDs

**65-21/T2C-FR1S2B17X/2T**

#### Reliability Test Items and Conditions

The reliability of products shall be satisfied with items listed below.

Confidence level : 90%

LTPD : 10%

No.	Items	Test Condition	Test Hours/Cycles	Sample Size	Ac/Re
1	Reflow Soldering	Temp. : 260 ±5 Max. 10 sec.	6 min	22 PCS.	0/1
2	Temperature Cycle	H : +100 15min ∫ 5 min L : -40 15min	300 Cycles	22 PCS.	0/1
3	Thermal Shock	H : +100 5min ∫ 10 sec L : -10 5min	300 Cycles	22 PCS.	0/1
4	High Temperature Storage	Temp. : 100	1000 Hrs.	22 PCS.	0/1
5	Low Temperature Storage	Temp. : -40	1000 Hrs.	22 PCS.	0/1
6	DC Operating Life	I <sub>F</sub> = 20 mA	1000 Hrs.	22 PCS.	0/1
7	High Temperature / High Humidity	85 / 85%RH	1000 Hrs.	22 PCS.	0/1

## Technical Data Sheet

### Mini Top View LEDs

**65-21/T2C-FR1S2B17X/2T**

#### Precautions for Use

1. Over-current-proof

Customer must apply resistors for protection; otherwise slight voltage shift will cause big current change (Burn out will happen).

2. Storage

2.1 Do not open moisture proof bag before the products are ready to use.

2.2 Before opening the package: The LEDs should be kept at 30 °C or less and 90%RH or less.

2.3 After opening the package: The LED's floor life is 1 year under 30 °C or less and 60% RH or less. If unused LEDs remain, it should be stored in moisture proof packages.

2.4 If the moisture absorbent material (silica gel) has faded away or the LEDs have exceeded the storage time, baking treatment should be performed using the following conditions.

Baking treatment: 60±5 °C for 24 hours.

3. Soldering Condition

3.1 Pb-free solder temperature profile

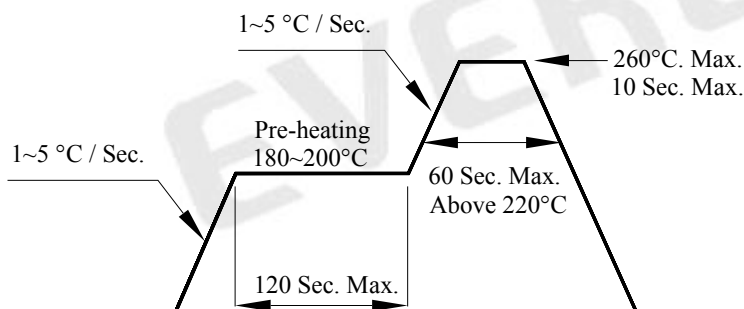

3.2 Reflow soldering should not be done more than two times.

3.3 When soldering, do not put stress on the LEDs during heating.

3.4 After soldering, do not warp the circuit board.

## Technical Data Sheet

### Mini Top View LEDs

**65-21/T2C-FR1S2B17X/2T**

#### 4. Soldering Iron

Each terminal is to go to the tip of soldering iron temperature less than 280 for 3 seconds within once in less than the soldering iron capacity 25W. Leave two seconds and more intervals, and do soldering of each terminal. Be careful because the damage of the product is often started at the time of the hand solder.

#### 5. Repairing

Repair should not be done after the LEDs have been soldered. When repairing is unavoidable, a double-head soldering iron should be used (as below figure). It should be confirmed beforehand whether the characteristics of the LEDs will or will not be damaged by repairing.

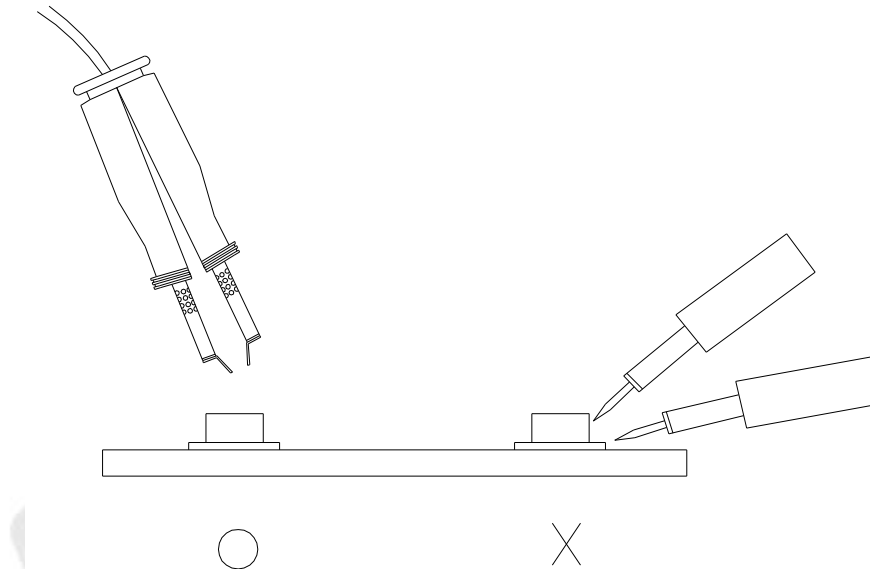

**EVERLIGHT ELECTRONICS CO., LTD.**  
Office: No 25, Lane 76, Sec 3, Chung Yang Rd,  
Tucheng, Taipei 236, Taiwan, R.O.C

Tel: 886-2-2267-2000, 2267-9936  
Fax: 886-2267-6244, 2267-6189, 2267-6306  
<http://www.everlight.com>