

60619-7 ✓ ACTIVE

MATE-N-LOK | Commercial MATE-N-LOK

TE Internal #: 60619-7

Commercial MATE-N-LOK, Power Contacts, Contact, 250 VAC, Gold, 20 – 14 AWG Wire Size, .52 – 2.08 mm² Wire Size, Wire-to-Wire, Wire & Cable, Crimp

[View on TE.com >](#)



Connectors > Power Connectors > Power Contacts



Power Contact Type: **Contact**

Operating Voltage: **250 VAC**

Contact Mating Area Plating Material: **Gold**

Wire Size: **.52 – 2.08 mm²**

Features

Product Type Features

Power Contact Type	Contact
Connector System	Wire-to-Wire
Connector & Contact Terminates To	Wire & Cable

Electrical Characteristics

Operating Voltage	250 VAC
-------------------	---------

Contact Features

Contact Shape & Form	Round
Contact Mating Area Plating Material	Gold
Contact Current Rating (Max)	15 A
Contact Type	Socket
Contact Retention Within Housing	With
Mating Pin Diameter	2.13 mm[.084 in]
Contact Base Material	Phosphor Bronze
Contact Mating Area Plating Material Thickness	.76 µm[30 µin]
Wire Contact Termination Area Plating Thickness	.76 µm[30 µin]



Wire Contact Termination Area Plating Material	Gold
Wire Contact Termination Area Plating Material Finish	Bright
Contact Orientation	Straight
Contact Underplating Material	Nickel
Contact Underplating Material Thickness	1.27 µm[50 µin]
Barrel Type	Open Barrel

Termination Features

Termination Method to Wire & Cable	Crimp
------------------------------------	-------

Mechanical Attachment

Contact Retention Type Within Housing	Locking Lance
Connector Mounting Type	Cable Mount (Free-Hanging)
Wire Insulation Support	Without

Dimensions

Wire Size	.52 – 2.08 mm ²
Accepts Wire Insulation Diameter Range	3.3 mm[.13 in]

Usage Conditions

Operating Temperature Range	-55 – 105 °C[-67 – 221 °F]
-----------------------------	----------------------------

Operation/Application

Circuit Application	Power
---------------------	-------

Industry Standards

Glow Wire Rating	Standard Part - Not Glow Wire
VDE Tested	No

Packaging Features

Packaging Method	Bag & Box
Packaging Quantity	1000

Other

Wire/Cable Type	Discrete Wire
Wire Type	Stranded
For Use With	Commercial MATE-N-LOK housings

Product Compliance





[For compliance documentation, visit the product page on TE.com>](#)

EU RoHS Directive 2011/65/EU	Compliant
EU ELV Directive 2000/53/EC	Not Yet Reviewed
China RoHS 2 Directive MIIT Order No 32, 2016	No Restricted Materials Above Threshold
EU REACH Regulation (EC) No. 1907/2006	Current ECHA Candidate List: JAN 2022 (223) Candidate List Declared Against: JAN 2021 (211) SVHC > Threshold: Not Yet Reviewed
Halogen Content	Low Halogen - Br, Cl, F, I < 900 ppm per homogenous material. Also BFR/CFR/PVC Free
Solder Process Capability	Not applicable for solder process capability

Product Compliance Disclaimer

This information is provided based on reasonable inquiry of our suppliers and represents our current actual knowledge based on the information they provided. This information is subject to change. The part numbers that TE has identified as EU RoHS compliant have a maximum concentration of 0.1% by weight in homogenous materials for lead, hexavalent chromium, mercury, PBB, PBDE, DBP, BBP, DEHP, DIBP, and 0.01% for cadmium, or qualify for an exemption to these limits as defined in the Annexes of Directive 2011/65/EU (RoHS2). Finished electrical and electronic equipment products will be CE marked as required by Directive 2011/65/EU. Components may not be CE marked. Additionally, the part numbers that TE has identified as EU ELV compliant have a maximum concentration of 0.1% by weight in homogenous materials for lead, hexavalent chromium, and mercury, and 0.01% for cadmium, or qualify for an exemption to these limits as defined in the Annexes of Directive 2000/53/EC (ELV). Regarding the REACH Regulation, the information TE provides on SVHC in articles for this part number is based on the latest European Chemicals Agency (ECHA) 'Guidance on requirements for substances in articles' posted at this URL: <https://echa.europa.eu/guidance-documents/guidance-on-reach>

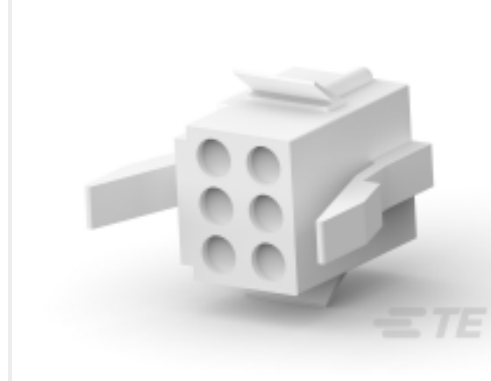
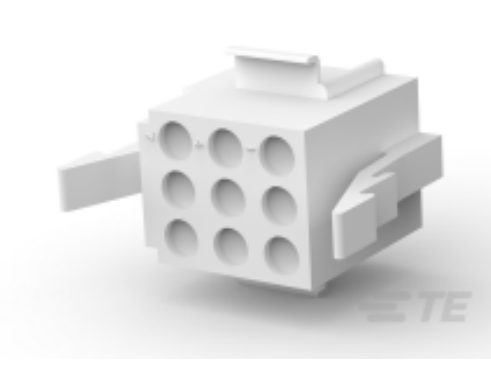
Compatible Parts

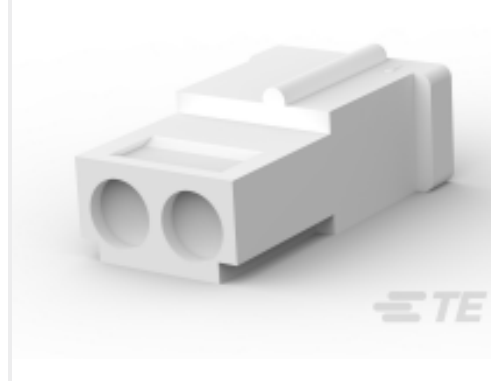
 <p>TE Part # 91504-1 CCII CMNL MNL PIN SKT 20-14 ASSY</p>	 <p>TE Part # 465644-1 EXTRACTION TOOL</p>	 <p>TE Part # 455830-1 INSERTION TOOL</p>	 <p>TE Part # 1-171196-0 6 POS MATE-N-LOK S</p>
 <p>TE Part # 1-480274-0 09P CMNL PLUG HSG P/M NATL</p>	 <p>TE Part # 1-480284-0 08P CMNL CAP HSG M/M NATL</p>	 <p>TE Part # 1-480438-0 16P CMNL PLUG HSG M/M NATL</p>	 <p>TE Part # 1-480683-0 02P CMNL PLUG HSG F/H NATL</p>



Also in the Series | Commercial MATE-N-LOK

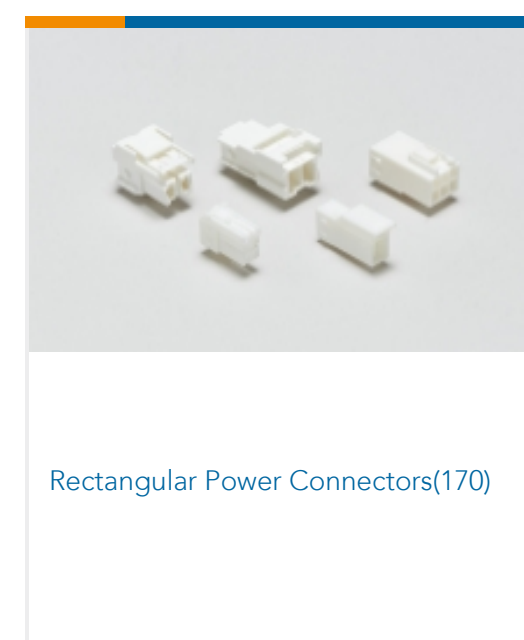
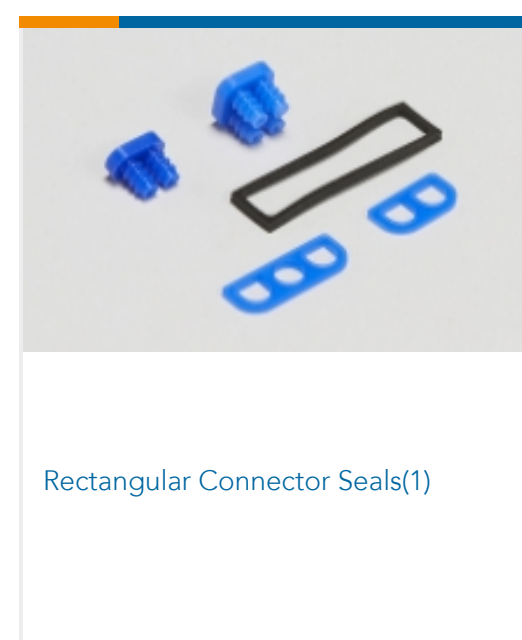
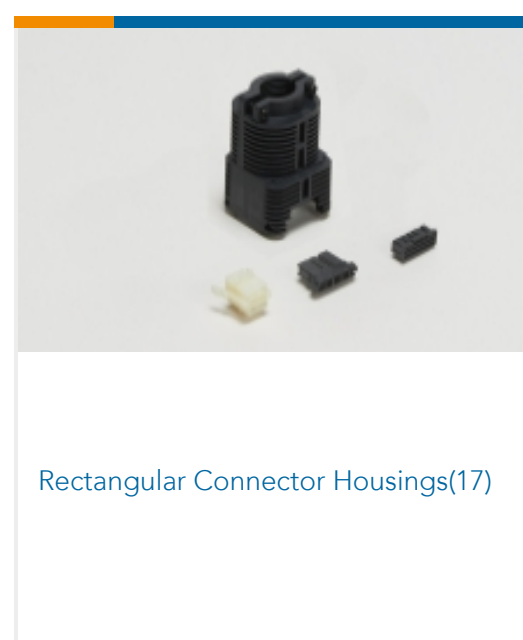
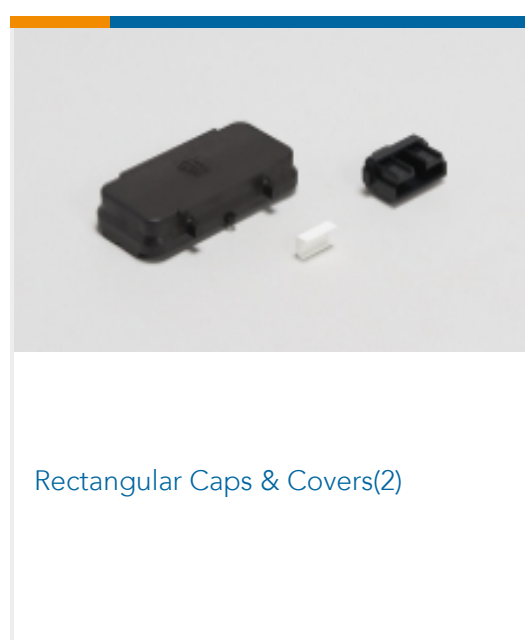
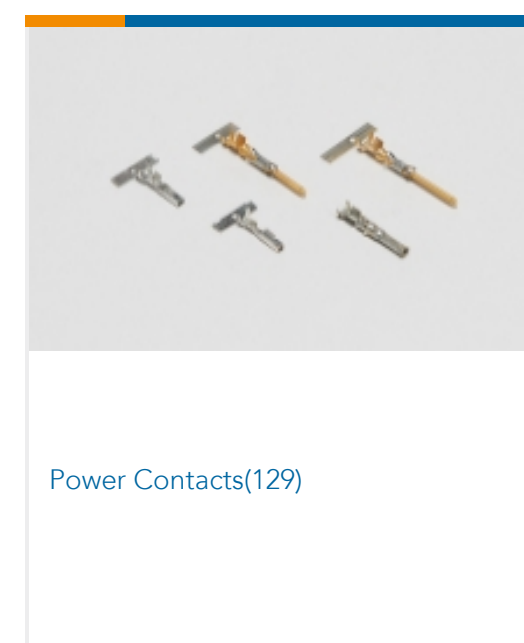
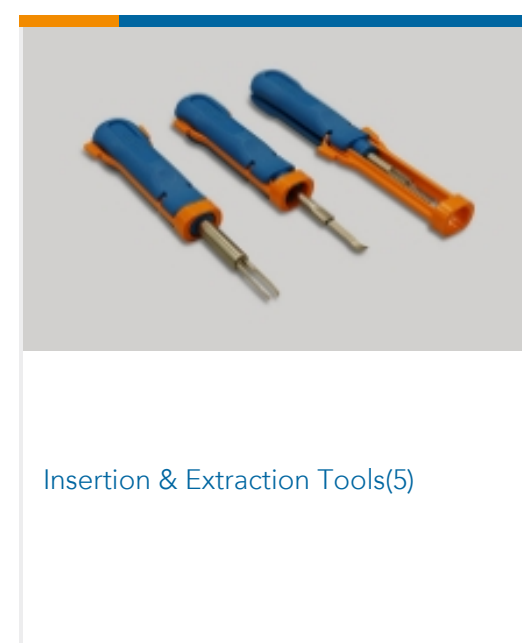
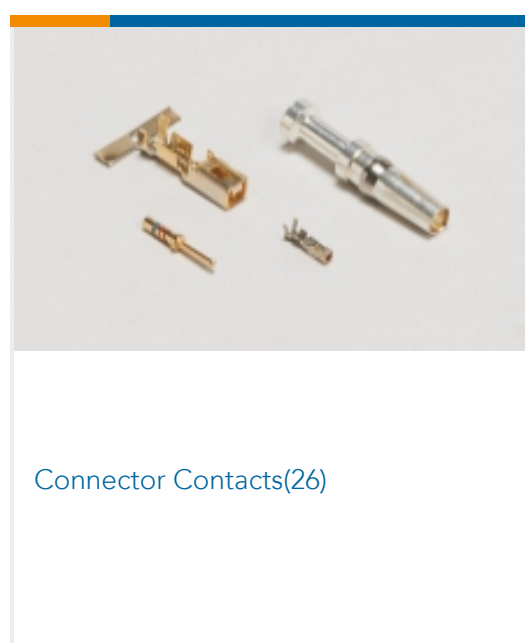



Standard Circular Connectors(4)



Standard Rectangular Connectors(10)



Wire-to-Board Connector Contacts(1)

Customers Also Bought

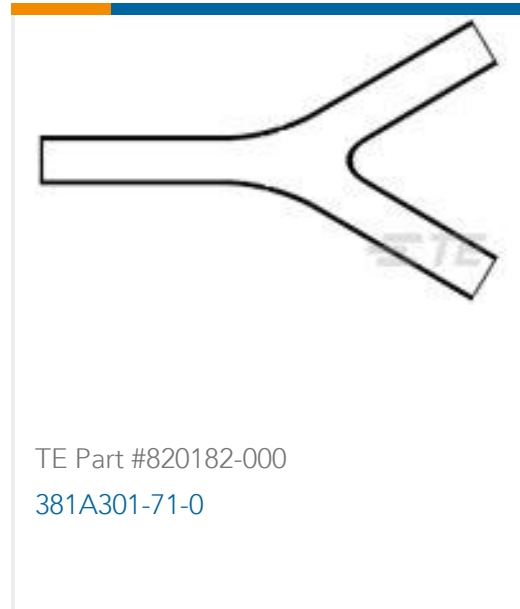
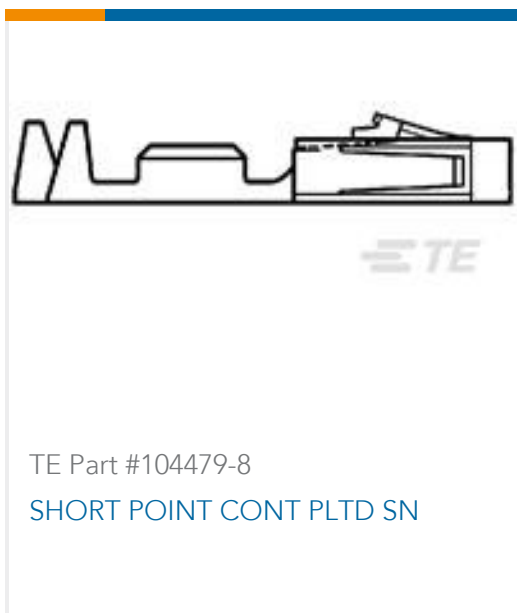
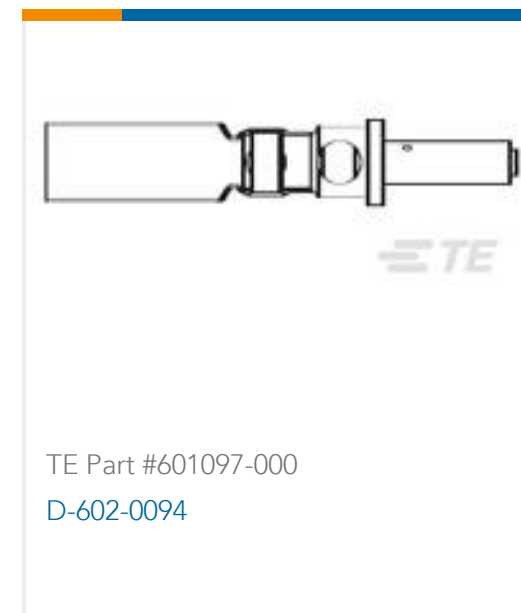
TE Part #2-36149-5
PIDG RING TONGUE TERMINALSTE Part #820182-000
381A301-71-0TE Part #1-480438-0
16P CMNL PLUG HSG M/M NATLTE Part #2-324061-5
TERMINAL,SOLIS R 8 8 HRTE Part #104479-8
SHORT POINT CONT PLTD SNTE Part #1600606-2
PANEL MT RECPT HSG W/GUIDES PTE Part #2-1658527-8
622-3441LF=FSKT IDC S 34 30AUTE Part #601097-000
D-602-0094

Documents

Product Drawings

[CMNL SOK AUPHBZ L/P](#)

English

CAD Files

[3D PDF](#)

3D

Customer View Model

[ENG_CVM_CVM_60619-7_Y.2d_dxf.zip](#)

English

Customer View Model

[ENG_CVM_CVM_60619-7_Y.3d_igs.zip](#)

English

Customer View Model

[ENG_CVM_CVM_60619-7_Y.3d_stp.zip](#)

English

By downloading the CAD file I accept and agree to the [Terms and Conditions](#) of use.



Datasheets & Catalog Pages

[SOFT_SHELL_PIN_SOCKET_CONNECTORS_STANDARD_DENSITY](#)

English

Product Specifications

[Application Specification](#)

English

Instruction Sheets

[Instruction Sheet \(U.S.\)](#)

English