

5435640-2 ✓ ACTIVE

Alcoswitch | Alcoswitch 7100

TE Internal #: 5435640-2

Alcoswitch 7100, DIP & SIP Switches, Switch, Gold, Blue Housing, Polyester GF, 4 Switch, -25 – 70 °C, DIP, Rocker (Top Actuated) Actuator Style, 1 A

[View on TE.com >](#)



Relays, Contactors & Switches > Switches > DIP & SIP Switches

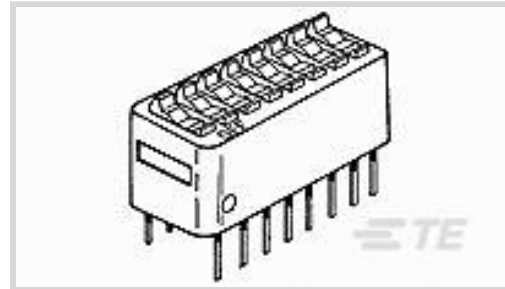

DIP & SIP Switch Product Type: **Switch**

DIP & SIP Switch Contact Mating Area Plating Material: **Gold**

DIP & SIP Switch Housing Color: **Blue**

DIP & SIP Switch Housing Material: **Polyester GF**

Auto-Insertable: **No**

## Features

### Product Type Features

DIP & SIP Switch Product Type	Switch
Sealed DIP & SIP Switch	No
DIP & SIP Switch Type	DIP
Actuator Style	Rocker (Top Actuated)

### Configuration Features

Number of Positions	4
Number of Switches	4
Configuration (Pole-Throw)	Single Pole - Single Throw

### Electrical Characteristics

DIP & SIP Switch Voltage Rating	40 VDC
---------------------------------	--------

### Contact Features

Solder Tail Contact Plating	Tin
	30 µin
DIP & SIP Switch Contact Mating Area Plating Material	Gold
Auto-Insertable	No
DIP & SIP Switch Contact Current Rating	1 A
Contact Base Material	Copper Alloy

### Termination Features

Termination Post Length	3.56 mm[.14 in]
-------------------------	-----------------

### Mechanical Attachment

Mounting Angle	Vertical
DIP & SIP Switch Mounting Type	Through Hole

### Housing Features

DIP & SIP Switch Housing Color	Blue
DIP & SIP Switch Housing Material	Polyester GF
DIP & SIP Switch Centerline	2.54 mm[.1 in]

### Dimensions

Height	8.64 mm[.34 in]
Length	12.19 mm[.48 in]

### Usage Conditions

Operating Temperature Range	-25 – 70 °C
-----------------------------	-------------

### Industry Standards

UL Flammability Rating	UL 94V-0
------------------------	----------

### Packaging Features

Packaging Method	Box & Carton
Packaging Quantity	50

### Other

Comment	Soldering in "off" position only
---------	----------------------------------

### Product Compliance

[For compliance documentation, visit the product page on TE.com>](#)

EU RoHS Directive 2011/65/EU	Compliant
EU ELV Directive 2000/53/EC	Compliant
China RoHS 2 Directive MIIT Order No 32, 2016	No Restricted Materials Above Threshold
EU REACH Regulation (EC) No. 1907/2006	Current ECHA Candidate List: JAN 2022 (223) Candidate List Declared Against: JAN 2021 (211) SVHC > Threshold: Not Yet Reviewed
Halogen Content	Not Low Halogen - contains Br or Cl > 900 ppm.

## Solder Process Capability

Wave solder capable to 265°C

## Product Compliance Disclaimer

This information is provided based on reasonable inquiry of our suppliers and represents our current actual knowledge based on the information they provided. This information is subject to change. The part numbers that TE has identified as EU RoHS compliant have a maximum concentration of 0.1% by weight in homogenous materials for lead, hexavalent chromium, mercury, PBB, PBDE, DBP, BBP, DEHP, DIBP, and 0.01% for cadmium, or qualify for an exemption to these limits as defined in the Annexes of Directive 2011/65/EU (RoHS2). Finished electrical and electronic equipment products will be CE marked as required by Directive 2011/65/EU. Components may not be CE marked. Additionally, the part numbers that TE has identified as EU ELV compliant have a maximum concentration of 0.1% by weight in homogenous materials for lead, hexavalent chromium, and mercury, and 0.01% for cadmium, or qualify for an exemption to these limits as defined in the Annexes of Directive 2000/53/EC (ELV). Regarding the REACH Regulation, the information TE provides on SVHC in articles for this part number is based on the latest European Chemicals Agency (ECHA) 'Guidance on requirements for substances in articles' posted at this URL: <https://echa.europa.eu/guidance-documents/guidance-on-reach>

## Compatible Parts

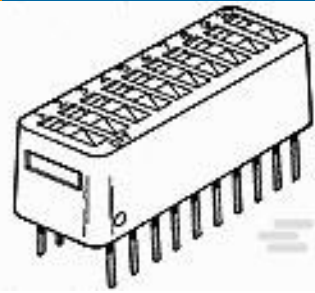

TE Part # 2-5435668-5  
DIP SW 6 POSN W/TAPE AU

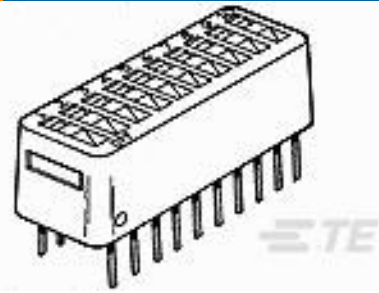

TE Part # 435668-7  
LO PROFILE DIP SW 8P AU

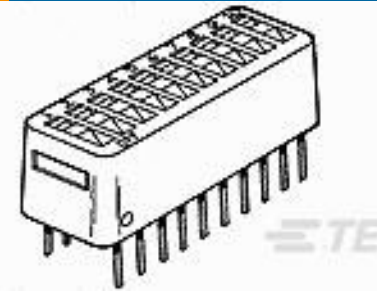

TE Part # 2-5435668-8  
DIP SW 8 POSN W/TAPE AU

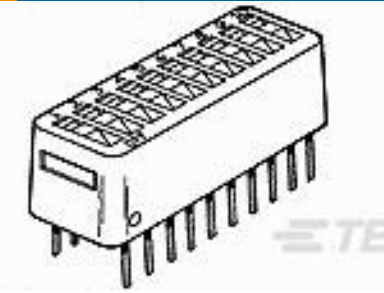

TE Part # 3-5435668-4  
DIP SW 4 POSN W/TAPE AU

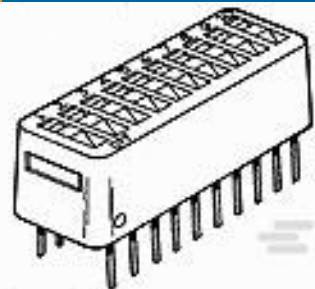

TE Part # 2-435668-5  
DIP SW 6 POSN W/TAPE AU

## Also in the Series | Alcoswitch 7100

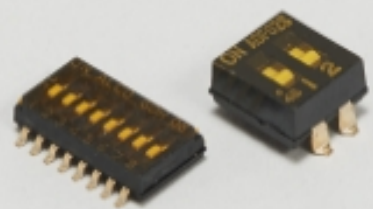

DIP & SIP Switches(35)

## Customers Also Bought

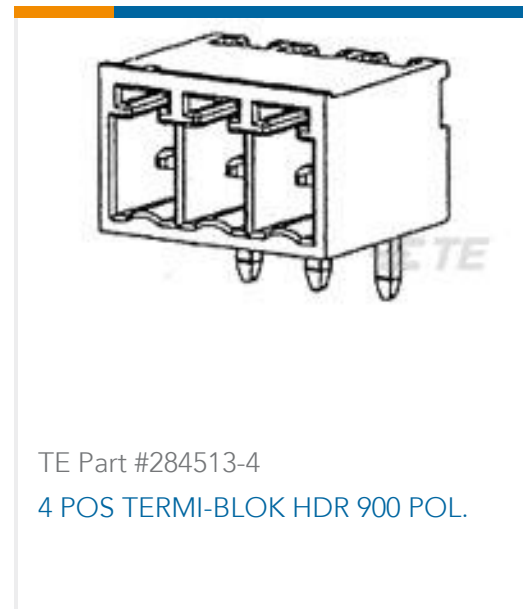

## Documents

### Product Drawings

DIP SW 4POSN AU

English

### CAD Files

3D PDF

English

Customer View Model

[ENG\\_CVM\\_5435640-2\\_A1.3d\\_igs.zip](#)

English

Customer View Model

[ENG\\_CVM\\_5435640-2\\_A1.3d\\_stp.zip](#)

English

Customer View Model

[ENG\\_CVM\\_5435640-2\\_A1.2d\\_dxf.zip](#)

English

By downloading the CAD file I accept and agree to the [Terms and Conditions](#) of use.

## Product Specifications



### Application Specification

English

---

### Instruction Sheets

#### Instruction Sheet (U.S.)

English