



AMP-LATCH | AMP-LATCH Universal Headers

TE Internal #: 5102153-8

AMP-LATCH Universal Headers, Ribbon Cable Connectors, Wire-to-Board, 34 Position, .1 in [2.54 mm] Centerline, Vertical, Through Hole - Solder, 2 Row

[View on TE.com >](#)

Connectors > PCB Connectors > Wire-to-Board Connectors > FFC, FPC & Ribbon Connectors > Ribbon Cable Connectors >

AMP-LATCH UNIVERSAL HEADERS

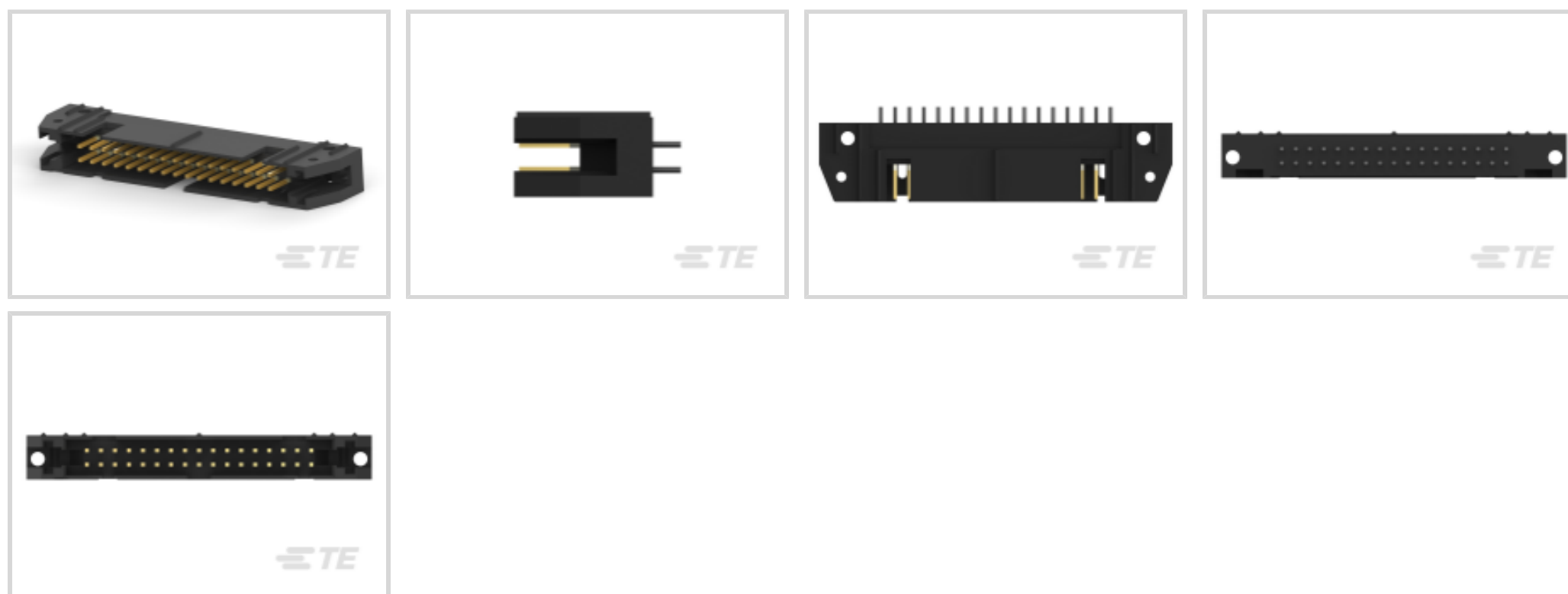

Connector System: **Wire-to-Board**

Number of Positions: **34**

Centerline (Pitch): **2.54 mm [.1 in]**

PCB Mount Retention: **Without**

PCB Mount Orientation: **Vertical**

[All AMP-LATCH UNIVERSAL HEADERS \(525\)](#)

Features

Product Type Features

Connector Type	Header
Ribbon Cable Connector Header Type	Universal Ejection Pin Headers
Connector Product Type	Connector Assembly
Connector System	Wire-to-Board
Connector & Housing Type	Plug
Connector & Contact Terminates To	Printed Circuit Board

Configuration Features

Number of Positions	34
PCB Mount Orientation	Vertical
Number of Rows	2

Electrical Characteristics

Insulation Resistance	5000 MΩ
-----------------------	---------



Operating Voltage	250 VAC
-------------------	---------

Body Features

Connector Profile	Standard
-------------------	----------

Contact Features

Mating Square Post Dimension	.64 mm[.025 in]
------------------------------	-----------------

PCB Contact Termination Area Plating Material Thickness	2.54 μ m[100 μ in]
---	----------------------------

Contact Type	Pin
--------------	-----

	15 μ in
--	-------------

Contact Mating Area Plating Material	Gold, Gold Flash
--------------------------------------	------------------

Contact Shape & Form	Square
----------------------	--------

Contact Underplating Material	Nickel
-------------------------------	--------

PCB Contact Termination Area Plating Material	Tin
---	-----

Contact Base Material	Phosphor Bronze
-----------------------	-----------------

Contact Current Rating (Max)	1 A
------------------------------	-----

Termination Features

Round Termination Post & Tail Diameter	.64 mm[.025 in]
--	-----------------

Termination Post & Tail Length	2.79 mm[.11 in]
--------------------------------	-----------------

Termination Method to Printed Circuit Board	Through Hole - Solder
---	-----------------------

Mechanical Attachment

Mating Alignment	With
------------------	------

PCB Mount Alignment	Without
---------------------	---------

Panel Mount Feature	Without
---------------------	---------

PCB Mount Retention	Without
---------------------	---------

Mating Alignment Type	Center, Dual Polarizing Bar
-----------------------	-----------------------------

Mating Retention	With
------------------	------

Mating Retention Type	Ejection Latch
-----------------------	----------------

Connector Mounting Type	Board Mount
-------------------------	-------------

Housing Features

Mating Entry Location	Top
-----------------------	-----

Housing Material	Nylon - GF
------------------	------------

Housing Color	Black
---------------	-------

Centerline (Pitch)	2.54 mm[.1 in]
--------------------	----------------



Dimensions

Shrouded End Dimension	3.81 mm[.15 in]
Connector Length	62.48 mm[2.46 in]
Connector Height	13.94 mm[.55 in]
PCB Thickness (Recommended)	1.57 mm[.062 in]
Row-to-Row Spacing	2.54 mm[.1 in]

Usage Conditions

Housing Temperature Rating	High
Operating Temperature Range	-65 – 105 °C[-85 – 221 °F]

Operation/Application

Circuit Application	Signal
---------------------	--------

Industry Standards

UL Flammability Rating	UL 94V-0
------------------------	----------

Packaging Features

Packaging Quantity	50
Packaging Method	Tray

Other

Comment	For Use With AMP-Latch Receptacle
---------	-----------------------------------

Product Compliance

[For compliance documentation, visit the product page on TE.com>](#)

EU RoHS Directive 2011/65/EU	Compliant
EU ELV Directive 2000/53/EC	Compliant
China RoHS 2 Directive MIIT Order No 32, 2016	No Restricted Materials Above Threshold
EU REACH Regulation (EC) No. 1907/2006	Current ECHA Candidate List: JAN 2022 (223) Candidate List Declared Against: JAN 2022 (223) Does not contain REACH SVHC
Halogen Content	Not Low Halogen - contains Br or Cl > 900 ppm.
Solder Process Capability	Wave solder capable to 265°C

Product Compliance Disclaimer

This information is provided based on reasonable inquiry of our suppliers and represents our current actual knowledge based on the information they provided. This information is subject to change. The part numbers that TE has identified as EU RoHS compliant have a maximum concentration of 0.1% by weight in homogenous materials for lead, hexavalent chromium, mercury, PBB, PBDE, DBP, BBP, DEHP, DIBP, and 0.01% for cadmium, or qualify for an exemption to these limits as defined in the Annexes of Directive 2011/65/EU (RoHS2). Finished electrical and electronic equipment products will be CE marked as required by Directive 2011/65/EU. Components may not be CE marked. Additionally, the part numbers that TE has identified as EU ELV compliant have a maximum concentration of 0.1% by weight in homogenous materials for lead, hexavalent chromium, and mercury, and 0.01% for cadmium, or qualify for an exemption to these limits as defined in the Annexes of Directive 2000/53/EC (ELV). Regarding the REACH Regulation, the information TE provides on SVHC in articles for this part number is based on the latest European Chemicals Agency (ECHA) 'Guidance on requirements for substances in articles' posted at this URL: <https://echa.europa.eu/guidance-documents/guidance-on-reach>

Compatible Parts



TE Part # 3-1437021-2
609-3431HD=FSKT IDC S 34 SR

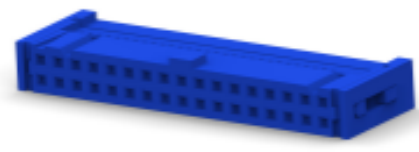

TE Part # 1-1658526-9
609-3441LF FEM SOCKET, LEAD FREE

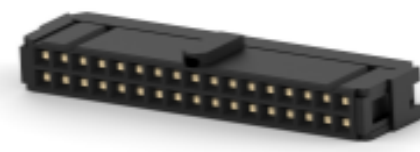

TE Part # 1658621-8
34 NOVO MIL/CTR 15DP, LEAD FREE



TE Part # 1658622-8
34 NOVO MIL/CTR 30DP, LEAD FREE



TE Part # 1658620-8
34 NOVO MIL 15DP, LEAD FREE



TE Part # 1658623-8
34 NOVO MIL 30DP, LEAD FREE

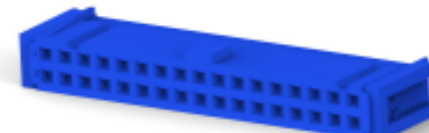

TE Part # 2-1658527-8
622-3441LF=FSKT IDC S 34 30AU

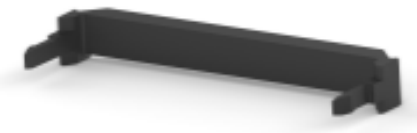

TE Part # 499252-6
034 STRAIN RELIEF A-L RCPT

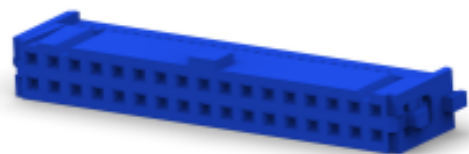

TE Part # 1-1658526-8
609-3430LF FEM SOCKET, LEAD FREE



TE Part # 1658624-8
034 NOVO DUAL 30DP FT



TE Part # 1658528-6
636-3441LF FEM SOCKET, LEAD FREE



TE Part # 3-6437021-6
609-3441CELF=FSKT IDC S 34 30A

Also in the Series | **AMP-LATCH Universal Headers**



Ribbon Cable Connectors(525)



Ribbon Connector Accessories(13)

Customers Also Bought

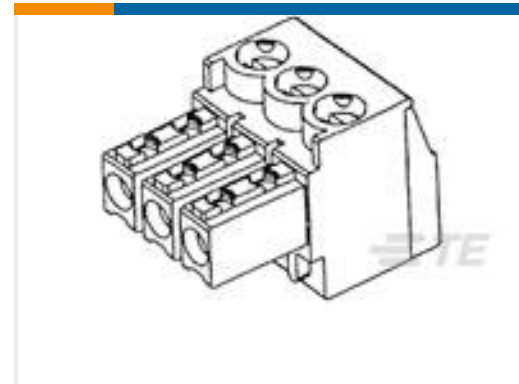
TE Part #5102153-6
AMP-LATCH UNIVERSAL HEADERSTE Part #5-146257-3
06 MODII HDR DRST B/A .100CL LFTE Part #2-1393194-1
T77V1D10-24TE Part #284506-6
6 POS TERMI-BLOK PLUG STACK 3,TE Part #284514-6
6 POS TERMI-BLOK HDR DIR. POL.TE Part #2-1825137-4
A105MD9AB04

Documents

Product Drawings

[A/L UNIV HDR 34P VERT](#)

English

CAD Files

[3D PDF](#)

3D

Customer View Model

[ENG_CVM_CVM_5102153-8_B.2d_dxf.zip](#)

English

Customer View Model

[ENG_CVM_CVM_5102153-8_B.3d_igs.zip](#)

English

Customer View Model

[ENG_CVM_CVM_5102153-8_B.3d_stp.zip](#)

English

By downloading the CAD file I accept and agree to the [Terms and Conditions](#) of use.



Datasheets & Catalog Pages

Ribbon Cable Interconnect Solutions

English

Product Specifications

Product Specification

English

Product Environmental Compliance

TE Material Declaration

English

Agency Approvals

Agency Approval Document

English