

5082-761x Series

7.6 mm (0.3 inch)/10.9 mm (0.43 inch)

Seven Segment Displays



Data Sheet

5082-761x Series/-762x Series/-765x Series/-766x Series
HDSP-360x Series/-460x Series/-E15x Series



Description

The 7.6 mm (0.3 inch) and 10.9 mm (0.43 inch) LED seven segment displays are designed for viewing distances up to 3 metres (10 feet) and 5 metres (16 feet). These devices use an industry standard size package and pinouts. All devices are available as either common anode or common cathode.

Features

- Industry standard size
- Industry standard pinout
 - 7.62 mm (0.300 inch) DIP leads on 2.54 mm (0.100 inch) centers
- Choice of colors
 - AlGaAs Red, High Efficiency Red, Yellow, Green
- Excellent appearance
 - Evenly lighted segments
 - $\pm 50^\circ$ viewing angle
 - Optimum contrast given by gray top surface for AlGaAs Red and Green devices
 - Red top surface for HER devices
 - Yellow top surface for yellow devices

Features, continued

- Design flexibility
 - Common anode or common cathode
 - Single digits
 - Left or right hand decimal point ± 1 . overflow character
- Categorized for luminous intensity
 - Yellow and Green categorized for color
 - Use of like categories yields a uniform display
- High light output
- High peak current
- Excellent for long digit string multiplexing
- Intensity and color selection available
 - See Intensity and Color Selected Displays Data Sheet
- Sunlight viewable AlGaAs

Devices

AlGaAs ^[1] Red HDSP-	HER ^[1] 5082-	Yellow 5082-	Green HDSP-	Description	Package Drawing
	7610	7620	3600	7.6 mm Common Anode Left Hand Decimal	A
	7611	7621	3601	7.6 mm Common Anode Right Hand Decimal	B
	7613	7623	3603	7.6 mm Common Cathode Right Hand Decimal	C
E150	7650		4600	10.9 mm Common Anode Left Hand Decimal	E
E151	7651	7661	4601	10.9 mm Common Anode Right Hand Decimal	F
E153	7653	7663	4603	10.9 mm Common Cathode Right Hand Decimal	G
E156	7656	7666	4606	10.9 mm Universal ± 1 . Overflow Right Hand Decimal ^[2]	H

Notes:

1. These displays are recommended for high ambient light operation. Please refer to the HDSP-E10X AlGaAs and HDSP-335X HER data sheet for low current operation.
2. Universal pinout brings the anode and cathode of each segment's LED out to separate pins. See internal diagram H.

Part Number

5082 - X XX X - X X X X

HDSP - X XX X - X X X X

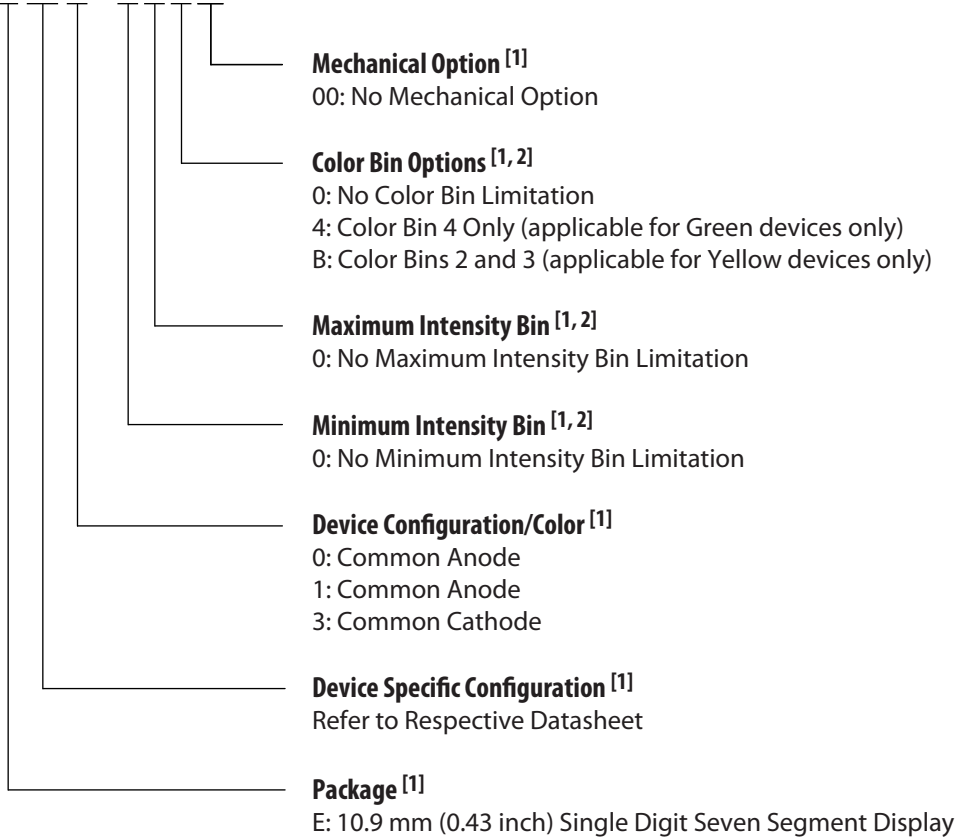

Notes:

1. For codes not listed in the figure above, please refer to the respective datasheet or contact your nearest Avago representative for details.
2. Bin options refer to shippable bins for a part number. Color and Intensity Bins are typically restricted to 1 bin per tube (exceptions may apply). Please refer to respective datasheet for specific bin limit information.

These displays are ideal for most portable applications. Pin for pin equivalent applications. The high light displays are also available in ambient displays are ideal for a low current or high light high light

ambients or long string ambient design. The low current lengths. For additional information see the Low Current Seven Segment Displays, or High Light Ambient Seven Segment Displays data sheets.

Package Dimensions

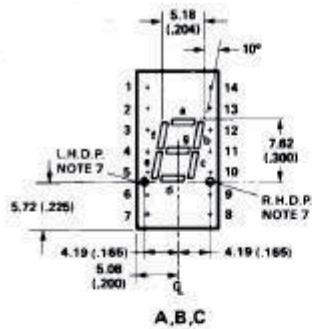

A,B,C

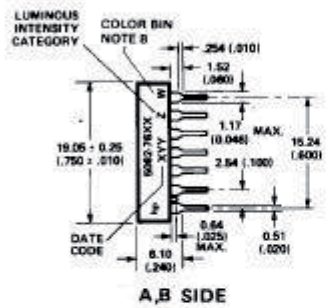

A,B SIDE

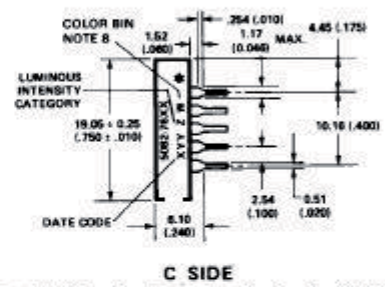

C SIDE

* The Side View of package indicates Country of Origin.

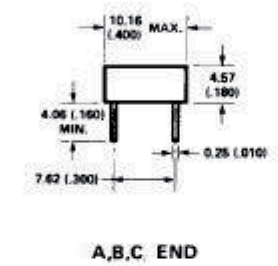

A,B,C END

- NOTES:
1. DIMENSIONS IN MILLIMETRES AND (INCHES).
 2. ALL UNTOLERANCED DIMENSIONS ARE FOR REFERENCE ONLY.
 3. REDUNDANT ANODES.
 4. UNUSED DP POSITION.
 5. SEE INTERNAL CIRCUIT DIAGRAM.
 6. REDUNDANT CATHODE.
 7. SEE PART NUMBER TABLE FOR L.H.D.P. AND R.H.D.P. DESIGNATION.
 8. FOR YELLOW AND GREEN DEVICES ONLY.

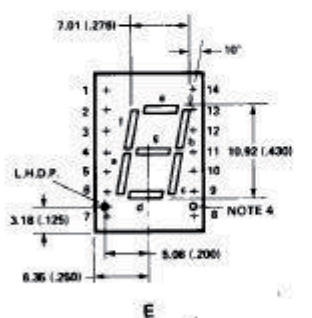

E

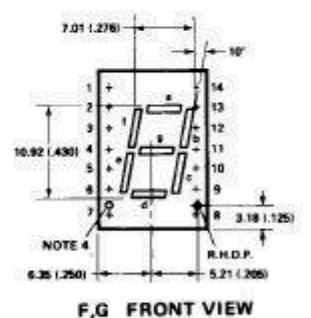

F,G FRONT VIEW

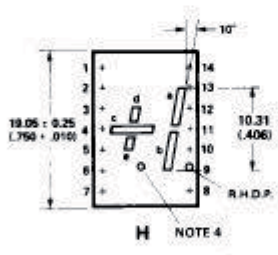

H

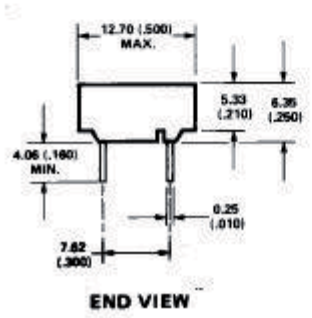

END VIEW

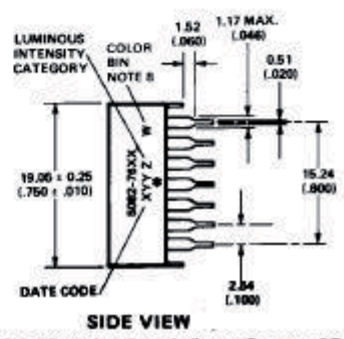

SIDE VIEW

* The Side View of package indicates Country of Origin.

PIN	FUNCTION		
	A	B	C
1	CATHODE-a	CATHODE-a	NO PIN
2	CATHODE-f	CATHODE-f	CATHODE ⁽¹⁾
3	ANODE ⁽²⁾	ANODE ⁽²⁾	ANODE-f
4	NO PIN	NO PIN	ANODE-g
5	NO PIN	NO PIN	ANODE-e
6	CATHODE-dp	NO CONN. ⁽³⁾	ANODE-d
7	CATHODE-e	CATHODE-e	NO PIN
8	CATHODE-d	CATHODE-d	NO PIN
9	NO CONN. ⁽³⁾	CATHODE-dp	CATHODE ⁽¹⁾
10	CATHODE-c	CATHODE-c	ANODE-dp
11	CATHODE-g	CATHODE-g	ANODE-c
12	NO PIN	NO PIN	ANODE-b
13	CATHODE-b	CATHODE-b	ANODE-a
14	ANODE ⁽²⁾	ANODE ⁽²⁾	NO PIN

PIN	FUNCTION			
	E	F	G	H
1	CATHODE-a	CATHODE-a	ANODE-a	CATHODE-d
2	CATHODE-f	CATHODE-f	ANODE-f	ANODE-d
3	ANODE ⁽²⁾	ANODE ⁽²⁾	CATHODE ⁽¹⁾	NO PIN
4	NO PIN	NO PIN	NO PIN	CATHODE-c
5	NO PIN	NO PIN	NO PIN	CATHODE-e
6	CATHODE-dp	NO CONN. ⁽³⁾	NO CONN. ⁽³⁾	ANODE-a
7	CATHODE-e	CATHODE-e	ANODE-a	ANODE-c
8	CATHODE-d	CATHODE-d	ANODE-d	ANODE-dp
9	NO CONN. ⁽³⁾	CATHODE-dp	ANODE-dp	CATHODE-dp
10	CATHODE-c	CATHODE-c	ANODE-c	CATHODE-b
11	CATHODE-g	CATHODE-g	ANODE-g	CATHODE-a
12	NO PIN	NO PIN	NO PIN	NO PIN
13	CATHODE-b	CATHODE-b	ANODE-b	ANODE-a
14	ANODE ⁽²⁾	ANODE ⁽²⁾	CATHODE ⁽¹⁾	ANODE-b

Internal Circuit Diagram

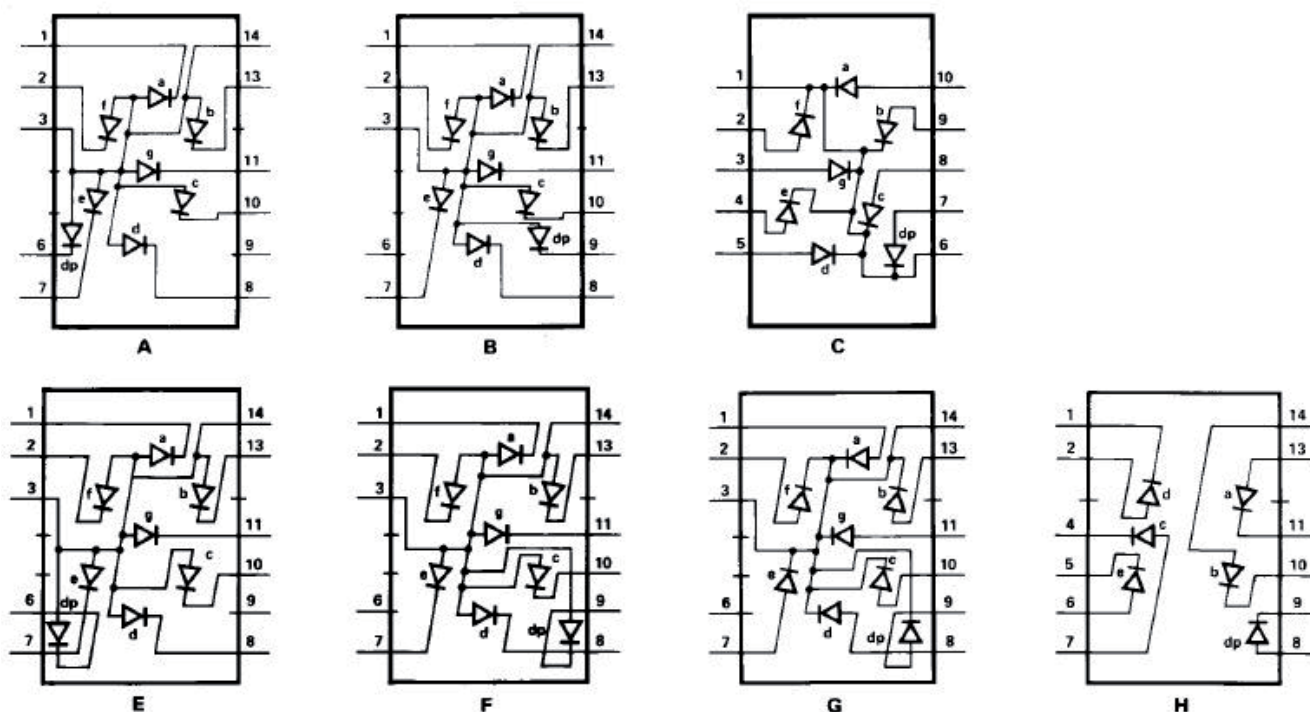

Absolute Maximum Ratings

Description	AlGaAs Red HDSP-E150 Series	HER 5082-7610/ 7650 Series	Yellow 5082-7620/ 7660 Series	Green HDSP-3600/ 4600 Series	Units
Average Power per Segment or DP	96	105	80	105	mW
Peak Forward Current per Segment or DP	160 ^[1]	90 ^[3]	60 ^[5]	90 ^[7]	mA
DC Forward Current per Segment or DP	40 ^[2]	30 ^[4]	20 ^[6]	30 ^[8]	mA
Operating Temperature Range	-20 to +100 ^[9]		-40 to +100		°C
Storage Temperature Range			-55 to +100°C		°C
Reverse Voltage per Segment or DP			3.0 V		V
Wave Soldering Temperature for 3 Seconds (1.59 mm [0.063 in.] below Body)			250		°C

Notes:

- See Figure 1 to establish pulsed conditions.
- Derate above 46°C at 0.54 mA/°C.
- See Figure 6 to establish pulsed conditions.
- Derate above 53°C at 0.45 mA/°C.
- See Figure 7 to establish pulsed conditions.
- Derate above 81°C at 0.52 mA/°C.
- See Figure 8 to establish pulsed conditions.
- Derate above 39°C at 0.37 mA/°C.
- For operation below -20°C, contact your local Avago components sales office or an authorized distributor.

Electrical/Optical Characteristics at $T_A = 25^\circ\text{C}$

AlGaAs Red

Device Series	Parameter	Symbol	Min.	Typ.	Max.	Units	Test Conditions
HDSP-E15x	Luminous Intensity/Segment ^[1,2,5] (Digit Average)	I_V	8.5	15.0		mcd	$I_F = 20\text{ mA}$
	Forward Voltage/Segment or DP	V_F			1.8	V	$I_F = 20\text{ mA}$
					2.0	3.0	V
	Peak Wavelength	λ_{PEAK}			645	nm	
	Dominant Wavelength ^[3]	λ_d			637	nm	
	Reverse Voltage/Segment or DP ^[4]	V_R	3.0	15		V	$I_R = 100\ \mu\text{A}$
	Temperature Coefficient of V_F / Segment or DP	$\Delta V_F/^\circ\text{C}$			-2	mV/ $^\circ\text{C}$	
Thermal Resistance LED Junction-to-Pin	$R_{\theta\text{J-PIN}}$			340	$^\circ\text{C/W/Seg}$		

High Efficiency Red

Device Series	Parameter	Symbol	Min.	Typ.	Max.	Units	Test Conditions	
5082-761x	Luminous Intensity/Segment ^[1,2,6] (Digit Average)	I_V	340	800		μcd	$I_F = 5\text{ mA}$	
5082-765x			340	1115		μcd	$I_F = 5\text{ mA}$	
All	Forward Voltage/Segment or DP	V_F			2.1	2.5	V	$I_F = 20\text{ mA}$
	Peak Wavelength	λ_{PEAK}			635	nm		
	Dominant Wavelength ^[3]	λ_d			626	nm		
	Reverse Voltage/Segment or DP ^[4]	V_R	3.0	30		V	$I_R = 100\ \mu\text{A}$	
	Temperature Coefficient of V_F / Segment or DP	$\Delta V_F/^\circ\text{C}$			-2	mV/ $^\circ\text{C}$		
	Thermal Resistance LED Junction-to-Pin	$R_{\theta\text{J-PIN}}$			280	$^\circ\text{C/W}$		

Yellow

Device Series	Parameter	Symbol	Min.	Typ.	Max.	Units	Test Conditions	
5082-762x	Luminous Intensity/Segment ^[1,2] (Digit Average)	I_V	205	620		μcd	$I_F = 5\text{ mA}$	
5082-766x			290	835		μcd	$I_F = 5\text{ mA}$	
All	Forward Voltage/Segment or DP	V_F			2.2	2.5	V	$I_F = 20\text{ mA}$
	Peak Wavelength	λ_{PEAK}			583	nm		
	Dominant Wavelength ^[3,7]	λ_d	581.5	586	592.5	nm		
	Reverse Voltage/Segment or DP ^[4]	V_R	3.0	40		V	$I_R = 100\ \mu\text{A}$	
	Temperature Coefficient of V_F / Segment or DP	$\Delta V_F/^\circ\text{C}$			-2	mV/ $^\circ\text{C}$		
	Thermal Resistance LED Junction-to-Pin	$R_{\theta\text{J-PIN}}$			280	$^\circ\text{C/W/Seg}$		

High Performance Green

Device Series	Parameter	Symbol	Min.	Typ.	Max.	Units	Test Conditions
HDSP-360x	Luminous Intensity/Segment ^[1,2] (Digit Average)	I_V	860	2700		μcd	$I_F = 10 \text{ mA}$
HDSP-460x			1030	4000		μcd	$I_F = 10 \text{ mA}$
All	Forward Voltage/Segment or DP	V_F		2.1	2.5	V	$I_F = 10 \text{ mA}$
	Peak Wavelength	λ_{PEAK}		566		nm	
	Dominant Wavelength ^[3,7]	λ_d		571	577	nm	
	Reverse Voltage/Segment or DP ^[4]	V_R	3.0	50		V	$I_F = 100 \mu\text{A}$
	Temperature Coefficient of V_F / Segment or DP	$\Delta V_F / ^\circ\text{C}$		-2		mV/ $^\circ\text{C}$	
	Thermal Resistance LED Junction-to-Pin	$R\theta_{\text{J-PIN}}$		280		$^\circ\text{C}/\text{W}/\text{Seg}$	

Notes:

1. Device case temperature is 25 $^\circ\text{C}$ prior to the intensity measurement.
2. The digits are categorized for luminous intensity. The intensity category is designated by a letter on the side of the package.
3. The dominant wavelength, λ_d , is derived from the CIE chromaticity diagram and is that single wavelength which defines the color of the device.
4. Typical specification for reference only. Do not exceed absolute maximum ratings.
5. For low current operation, the AlGaAs HDSP-E10X series displays are recommended. They are tested at 1 mA dc/segment and are pin for pin compatible with the HDSP-E15X series.
6. For low current operation, the HER HDSP-335X series displays are recommended. They are tested at 2 mA dc/segment and are pin for pin compatible with the 5082-7650 series.
7. The Yellow (5082-7620/7660) and Green (HDSP-3600/4600) displays are categorized for dominant wavelength. The category is designated by a number adjacent to the luminous intensity category letter.

AlGaAs Red

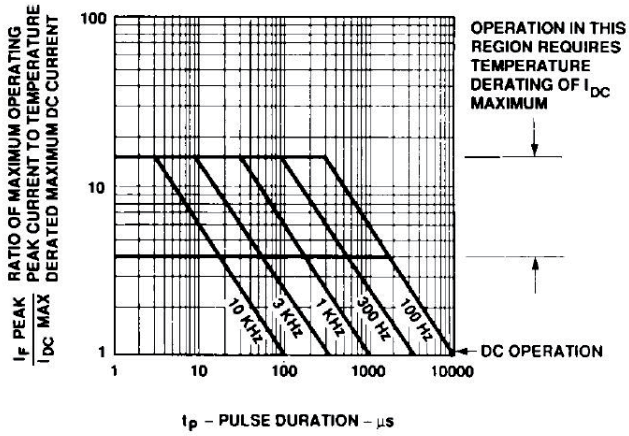

Figure 1. Maximum Allowed Peak Current vs. Pulse Duration – AlGaAs Red.

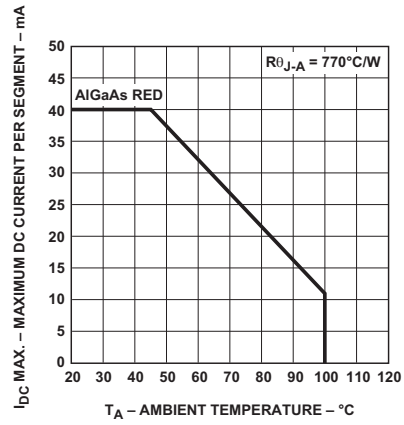

Figure 2. Maximum Allowable DC Current vs. Ambient Temperature.

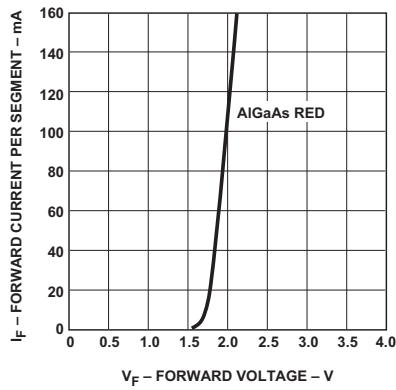

Figure 3. Forward Current vs. Forward Voltage.

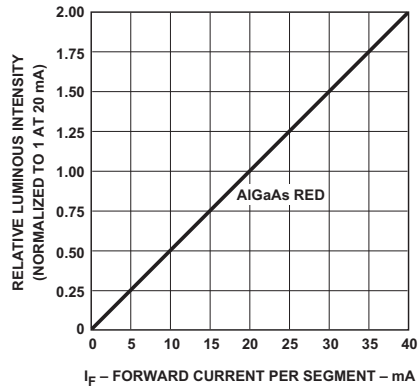

Figure 4. Relative Luminous Intensity vs. DC Forward Current.

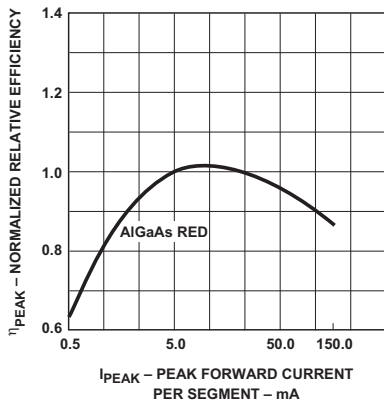

Figure 5. Relative Efficiency (Luminous Intensity per Unit Current) vs. Peak Current.

HER, Yellow, Green

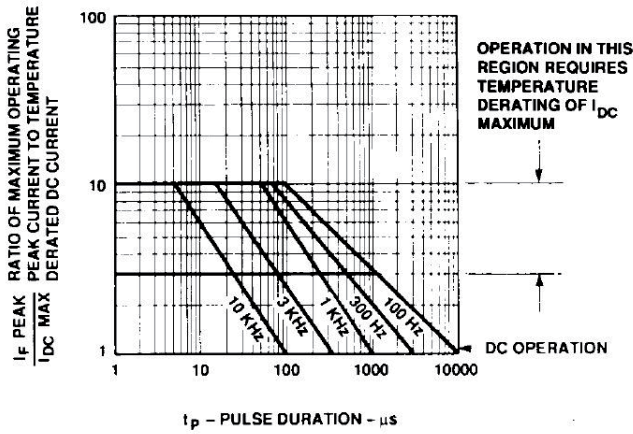

Figure 6. Maximum Tolerable Peak Current vs. Pulse Duration – HER Series.

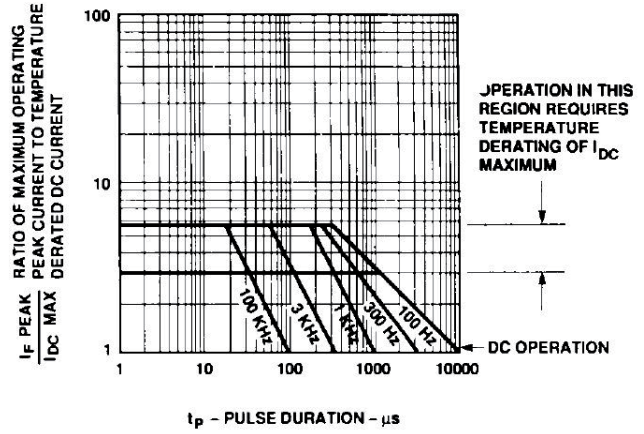

Figure 7. Maximum Tolerable Peak Current vs. Pulse Duration – Yellow Series.

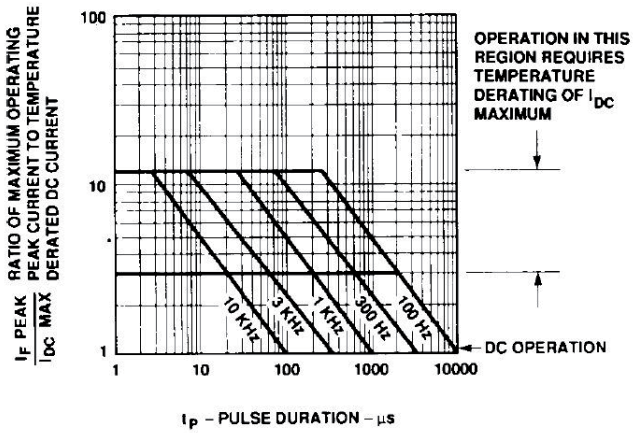

Figure 8. Allowable Peak Current vs. Pulse Duration – Green Series.

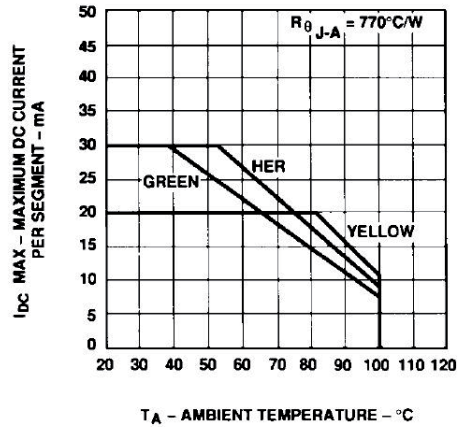

Figure 9. Maximum Allowable DC Current vs. Ambient Temperature.

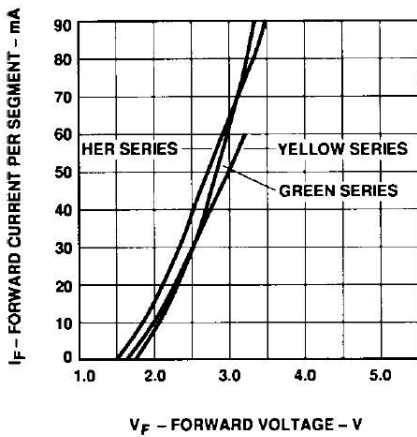

Figure 10. Forward Current vs. Forward Voltage.

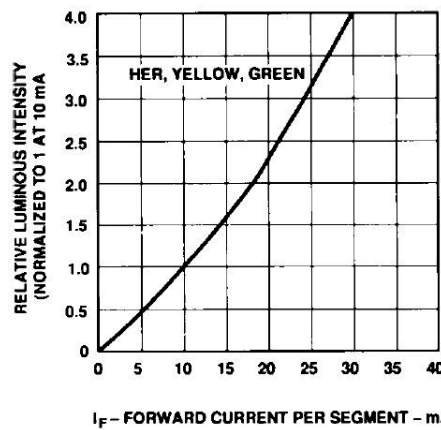

Figure 11. Relative Luminous Intensity vs. DC Forward Current.

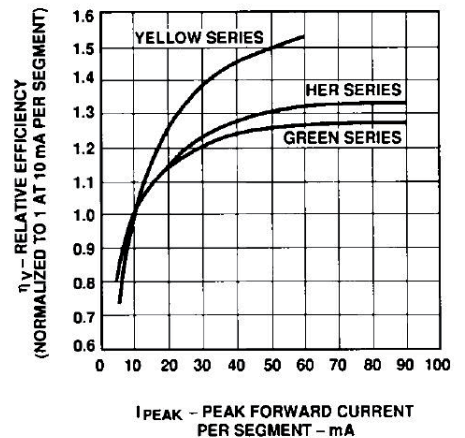

Figure 12. Relative Luminous Efficiency (Luminous Intensity per Unit Current) vs. Peak Current.

Intensity Bin Limits (mcd)

AlGaAs Red

HDSP-E15x		
IV Bin Category	Min.	Max.
L	8.67	15.90
M	13.00	23.80
N	19.50	35.80
O	29.30	53.60
P	43.90	80.50

HER

5082-761x		
IV Bin Category	Min.	Max.
B	0.369	0.630
C	0.516	0.946
D	0.774	1.418
E	1.160	2.127
F	1.740	3.190
G	2.610	4.785
H	3.915	7.177

5082-765x		
IV Bin Category	Min.	Max.
B	0.347	0.593
C	0.485	0.890
D	0.728	1.333
E	1.091	2.000
F	1.636	3.000
G	2.454	4.500
H	3.682	6.751

Yellow

5082-762x		
IV Bin Category	Min.	Max.
B	0.229	0.387
C	0.317	0.582
D	0.476	0.872
E	0.714	1.311
F	1.073	1.967
G	1.609	2.950
H	2.413	4.425

5082-766x		
IV Bin Category	Min.	Max.
C	0.297	0.543
D	0.445	0.817
E	0.669	1.225
F	1.003	1.838
G	1.504	2.758
H	2.256	4.137

Green

HDSP-360x		
IV Bin Category	Min.	Max.
H	0.86	1.58
I	1.29	2.37
J	1.94	3.55
K	2.90	5.33
L	4.37	8.01

HDSP-460x		
IV Bin Category	Min.	Max.
G	1.03	1.88
H	1.54	2.82
I	2.31	4.23
J	3.46	6.34
K	5.18	9.50
L	7.78	14.26

Color Categories

Color	Bin	Dominant Wavelength (nm)	
		Min.	Max.
Yellow	1	581.50	585.00
	3	584.00	587.50
	2	586.50	590.00
	4	589.00	592.50
Green	2	573.00	577.00
	3	570.00	574.00
	4	567.00	571.00
	5	564.00	568.00

Note:

All categories are established for classification of products. Products may not be available in all categories. Please contact your Avago representatives for further clarification/information.

Contrast Enhancement

For information on contrast enhancement, please see Application Note 1015.

Soldering/Cleaning

For information on soldering LEDs, please refer to Application Note 1027.

For product information and a complete list of distributors, please go to our web site: www.avagotech.com

Avago, Avago Technologies, and the A logo are trademarks of Avago Technologies in the United States and other countries. Data subject to change. Copyright © 2005-2011 Avago Technologies. All rights reserved. Obsoletes 5988-3325EN AV02-2550EN - January 27, 2011

AVAGO
TECHNOLOGIES