

42710-2 ✓ ACTIVE

FASTON | FASTON 205

TE Internal #: 42710-2

FASTON 205, Quick Disconnects, Receptacle, 22 – 18 AWG Wire Size, .32 – .82 mm² Wire Size, Mating Tab Width .205 in [5.21 mm], Straight, Brass

[View on TE.com >](#)



Terminals & Splices > Quick Disconnects

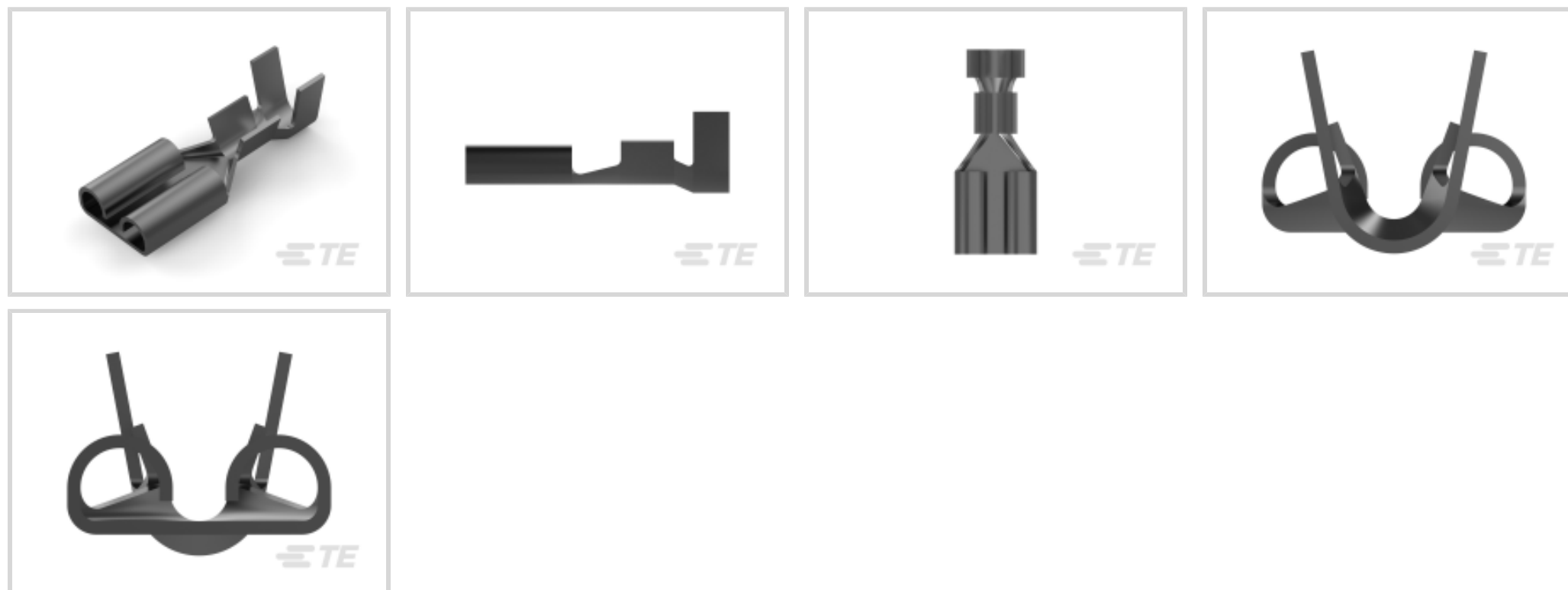

Quick Disconnect Terminal Type: **Receptacle**

Wire Size: .32 – .82 mm²

Mating Tab Width: 5.21 mm [.205 in]

Mating Tab Thickness: .51 mm [.02 in]

Features

Product Type Features

Terminates To	Wire & Cable
Wire Stop	No
Wire/Cable Type	Regular Wire
Insertion Force	Low
Sealable	No

Configuration Features

Connection Capacity	Single
---------------------	--------

Contact Features

Quick Disconnect Terminal Type	Receptacle
Mating Tab Width	5.21 mm[.205 in]
Mating Tab Thickness	.51 mm[.02 in]
Terminal Orientation	Straight
Contact Base Material	Brass
Terminal Plating Material	Tin
Crimp Type	F-Crimp



Barrel Type	Open
-------------	------

Mechanical Attachment

Mating Retention Type	Dimple
Wire Insulation Support	With

Dimensions

Accepts Wire Insulation Diameter Range	2.16 – 3.18 mm [.085 – .125 in]
Overall Length	15.62 mm [.616 in]
Receptacle Terminal Stock Thickness	.33 mm [.013 in]
Wire Size	.32 – .82 mm ²

Usage Conditions

Insulation Requirement	Uninsulated
Operating Temperature Range	-40 – 110 °C [-40 – 230 °F]

Industry Standards

UL Rating	Listed
CSA Certified	Yes

Packaging Features

Packaging Quantity	15000
Packaging Method	Strip/Reel

Product Compliance

[For compliance documentation, visit the product page on TE.com>](#)

EU RoHS Directive 2011/65/EU	Compliant
EU ELV Directive 2000/53/EC	Compliant
China RoHS 2 Directive MIIT Order No 32, 2016	No Restricted Materials Above Threshold
EU REACH Regulation (EC) No. 1907/2006	Current ECHA Candidate List: JAN 2022 (223) Candidate List Declared Against: JUL 2021 (219) SVHC > Threshold: Not Yet Reviewed
Halogen Content	Low Halogen - Br, Cl, F, I < 900 ppm per homogenous material. Also BFR/CFR/PVC Free
Solder Process Capability	Not applicable for solder process capability

Product Compliance Disclaimer

This information is provided based on reasonable inquiry of our suppliers and represents our current actual knowledge based on the information they provided. This information is subject to change. The part numbers that TE has identified as EU RoHS compliant have a maximum concentration of 0.1% by weight in homogenous materials for lead, hexavalent chromium, mercury, PBB, PBDE, DBP, BBP, DEHP, DIBP, and 0.01% for cadmium, or qualify for an exemption to these limits as defined in the Annexes of Directive 2011/65/EU (RoHS2). Finished electrical and electronic equipment products will be CE marked as required by Directive 2011/65/EU. Components may not be CE marked. Additionally, the part numbers that TE has identified as EU ELV compliant have a maximum concentration of 0.1% by weight in homogenous materials for lead, hexavalent chromium, and mercury, and 0.01% for cadmium, or qualify for an exemption to these limits as defined in the Annexes of Directive 2000/53/EC (ELV). Regarding the REACH Regulation, the information TE provides on SVHC in articles for this part number is based on the latest European Chemicals Agency (ECHA) 'Guidance on requirements for substances in articles' posted at this URL: <https://echa.europa.eu/guidance-documents/guidance-on-reach>

Compatible Parts



TE Part # 1742754-1
FASTON RECEPTACLE 26-22 AWG
TPBR



TE Part # 2-2150258-1
OCEAN_2.0_Applicator-E-090F140F



TE Part # 2-2150258-2
OCEAN_2.0_Applicator-E-090F140FA



TE Part # 2150258-1
OCEAN_2.0_Applicator-E-090F140F



TE Part # 2150258-2
OCEAN_2.0_Applicator-E-090F140FA



TE Part # 7-2150258-1
OCEAN_2.0_Applicator-E-090F140F



TE Part # 7-2150258-2
OCEAN_2.0_Applicator-E-090F140FA



KIT
REPRESENTATION ONLY
TE Part # 7-2150258-7
OCEAN_2.0_SPARE_PART_KIT-090F140F

Also in the Series | FASTON 205



Crimp Terminal Housings(3)



PCB Terminals(9)



Quick Disconnects(36)

Customers Also Bought



TE Part #2-31894-2
PIDG 22-16 22-18MIL R 1/4;TAPE

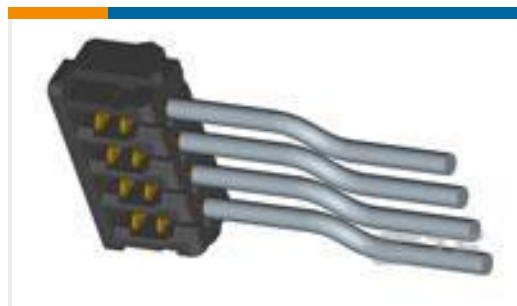

TE Part #2-179694-2
2MM CT MT REC ASSY 2P GRAY



TE Part #647466-2
SL156 RECPT,AUNI/PHBZ,16AWG



TE Part #794942-1
10P MINI UMNL CAP HSG

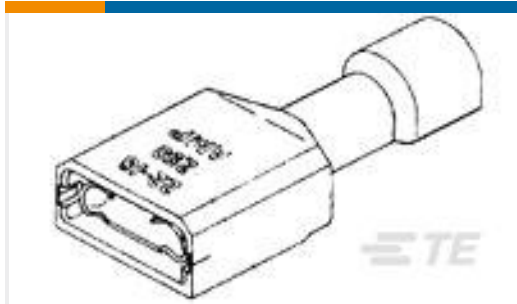

TE Part #2-521406-2
205 ULTRA-FAST RCPT 22-18 TPBR

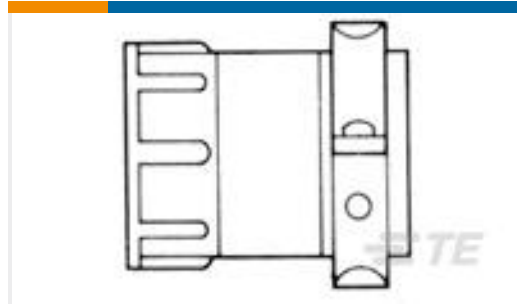

TE Part #206322-6
CABLE CLAMP KIT,BULK PKG



TE Part #7-1452656-1
MCON 1.2 LL REC SRC SN

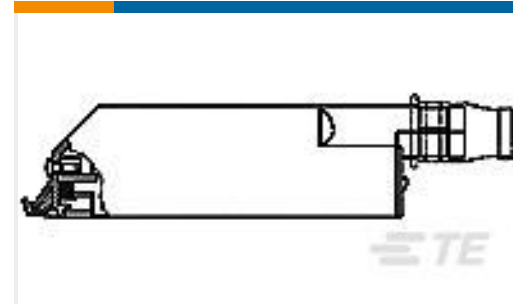

TE Part #826000-5
35P HSG JR TIMER KIT



TE Part #1-166500-2
TANDEM SPR. STAND REEL



TE Part #2-66741-1
TYPE XII FEMALE CONT (L.P.)

Documents

Product Drawings

[205 FASTON REC 22-18 AWG TPBR](#)

English

CAD Files

Customer View Model

[ENG_CVM_CVM_42710-2_Y.2d_dxf.zip](#)

English

3D PDF

3D

Customer View Model

[ENG_CVM_CVM_42710-2_Y.3d_igs.zip](#)

English

Customer View Model

[ENG_CVM_CVM_42710-2_Y.3d_stp.zip](#)

English

By downloading the CAD file I accept and agree to the [Terms and Conditions](#) of use.

Datasheets & Catalog Pages



82004 FASTON Terminals (Insulated and Uninsulated) Catalog - FASTON Receptacles Section

English

Product Specifications

Application Specification

English

Product Environmental Compliance

Product Compliance

English

Product Compliance

English

Agency Approvals

UL Report

English