

1.8 mm Round Subminiature LED

42-21

Features:

- PACKAGE IN 12mm TAPE ON 177.8mm(7") DIAMETER REELS.
- COMPATIBLE WITH AUTOMATIC PLACEMENT EQUIPMENT.
- COMPATIBLE WITH INFRARED AND VAPOR PHASE REFLOW SOLDER PROCESS.
- EIA STD PACKAGE.
- I.C. COMPATIBLE.

Applications:

- Automotive:backlighting in dashboard and switch.
- Telecommunication:indicator and backlighting in telephone and fax.
- Indicator and backlight for audio and video equipment.
- Indicator and backlight for battery driven equipment.
- Small indicator for outdoor applications.
- Indicator and backlight in office equipment.
- Flat backlight for LCD, switch and symbol.
- General use.

Package Dimensions:

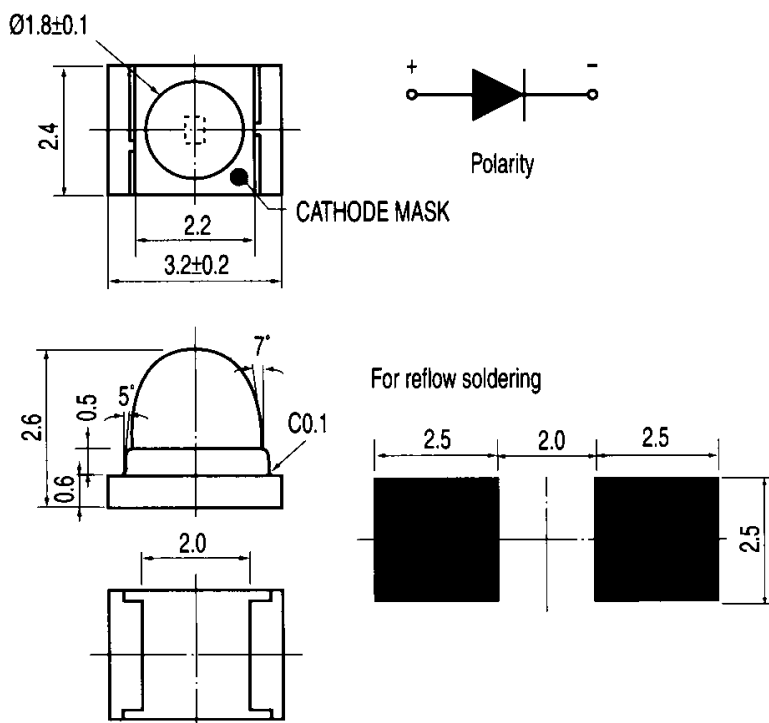

NOTES:

1. Tolerance Unless Dimension ± 0.1 mm Angle $\pm 0.5^\circ$.
2. Unit: mm

Model No:

MODEL	EMITTED COLOR	MATERIAL
EL-42-21VRC/TR8	RED	GaAsP/GaP
EL-42-21VGC/TR8	GREEN	GaP
EL-42-21VYC/TR8	YELLOW	GaAsP/GaP
EL-42-21SRC/TR8	SUPER RED	GaAlAs
EL-42-21UYC/S400/TR8	SUPER YELLOW	AlGaInP
EL-42-21USOC/S400/TR8	SUPER SUNSET ORANGE	AlGaInP

Absolute Maximum Ratings: (Ta=25°C)

Reverse Voltage	4 Volt
Reverse Current	100 μ A
Operating Temperature Range	-40°C to 85°C
Storage Temperature Range	-40°C to 90°C
Lead Soldering Temperature Range	260°C for 5 seconds

Part Selection and Application Information

MODEL	ABSOLUTE MAXIMUM RATING					ELECTRO-OPTICAL CHARACTERISTICS				Iv			VIEWING ANGLE 2 θ 1/2
	λ_p (nm)	$\Delta\lambda$ (nm)	Pd (mW)	If (mA)	(peak) If (mA)	Vf(V)			(Rec.) If (mA)	UNIT=mcd CONDITION=20mA			
						Min.	Typ.	Max.		Min.	Typ.	Max.	
EL-42-21VRC/TR8	640	45	100	30	160	1.7	2.0	2.8	20	23.5	39.0	----	30
EL-42-21VGC/TR8	570	30	100	30	160	1.7	2.1	2.8	20	73.0	122.0	----	30
EL-42-21VYC/TR8	590	35	85	20	160	1.7	2.0	2.8	20	35.0	58.5	----	30
EL-42-21SRC/TR8	660	20	110	40	200	1.5	1.7	2.4	20	114.0	190.0	----	30
EL-42-21UYC/S400/TR8	590	15	100	50	160	1.7	2.0	2.8	20	346.0	606.0	----	30
EL-42-21USOC/S400/TR8	620	18	100	50	160	1.7	2.0	2.8	20	490.0	820.0	----	30

Viewing Angle:

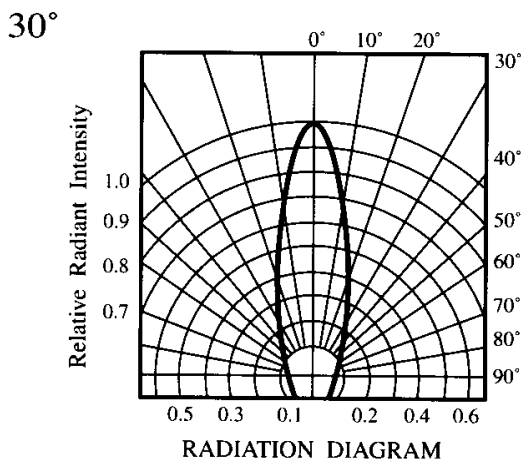

VR Series

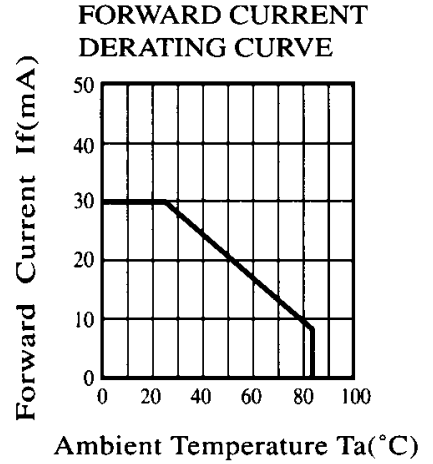
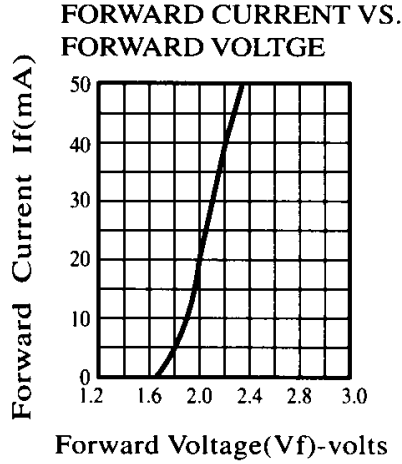
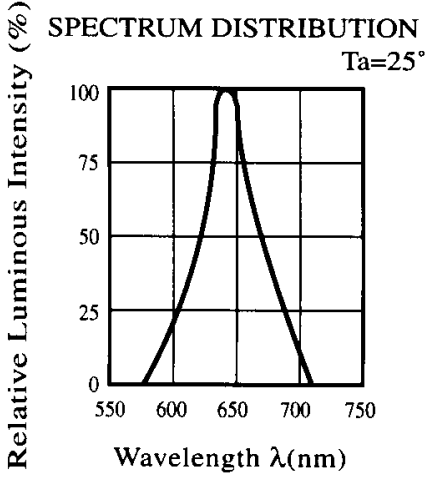

VG Series

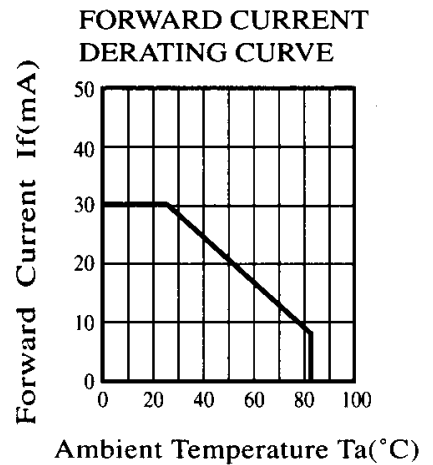
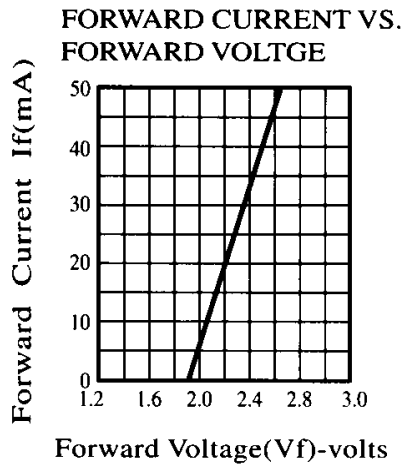
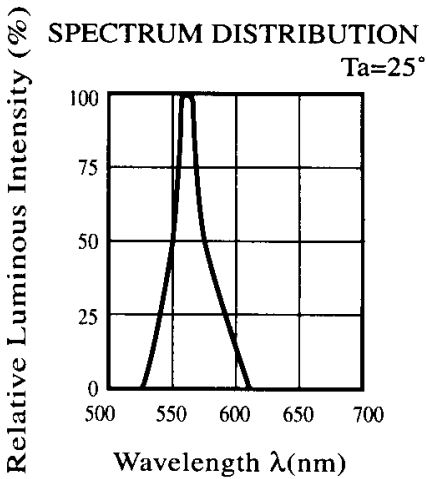

VY Series

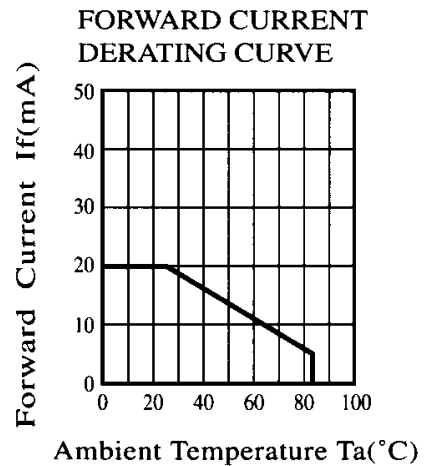
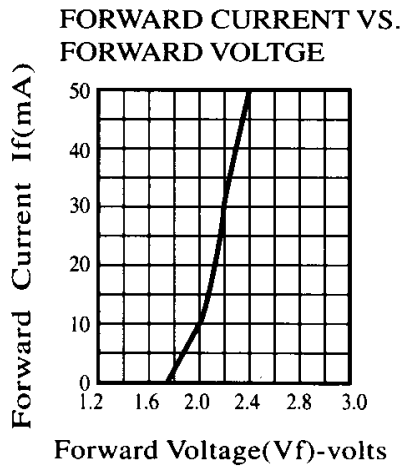
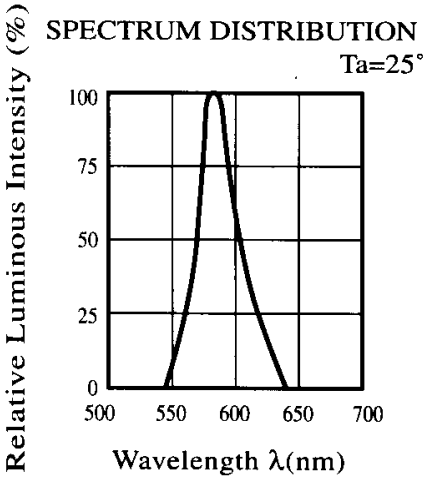

SR Series

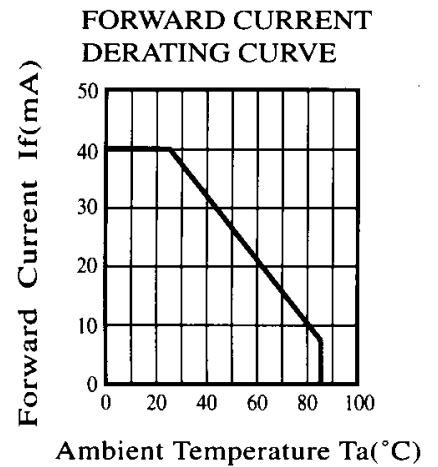
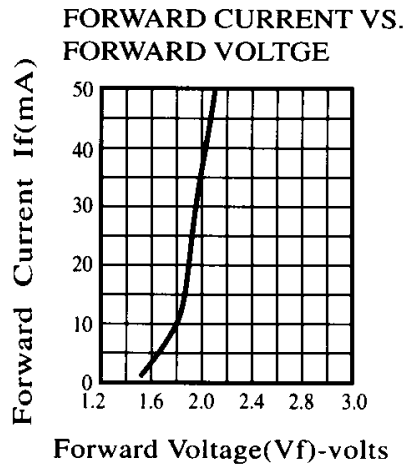
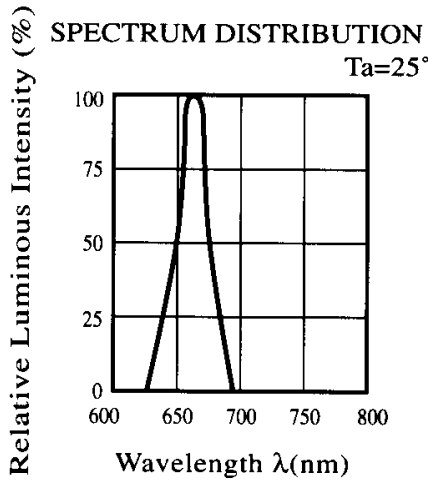

UY Series

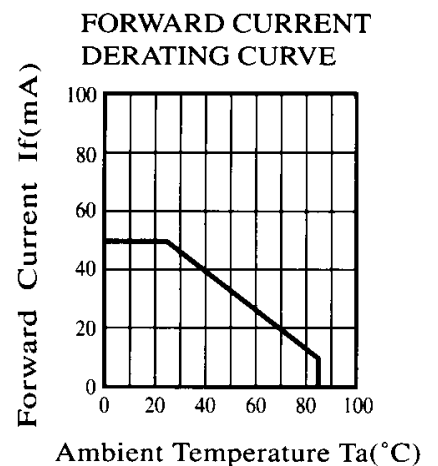
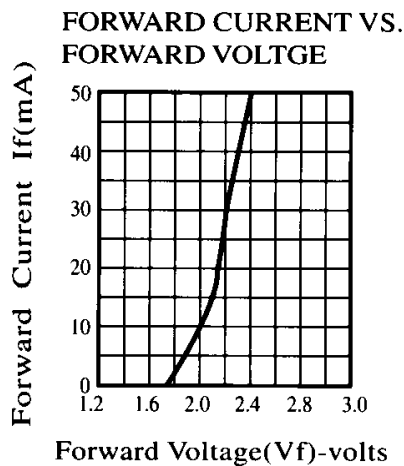
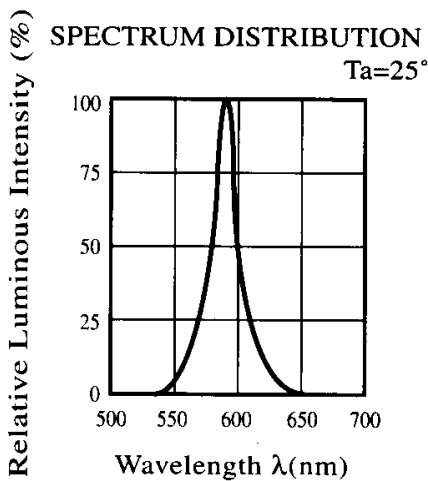

USO Series

