

41772-1 ✓ ACTIVE

FASTON | FASTON 250

TE Internal #: 41772-1

FASTON 250, Quick Disconnects, Receptacle, 22 – 18 AWG Wire Size, .32 – .82 mm² Wire Size, Mating Tab Width .25 in [6.35 mm], Straight, Brass

[View on TE.com >](#)



Terminals & Splices > Quick Disconnects



Quick Disconnect Terminal Type: **Receptacle**

Wire Size: .32 – .82 mm²

Mating Tab Width: 6.35 mm [.25 in]

Mating Tab Thickness: .81 mm [.032 in]

Features

Product Type Features

Terminates To	Wire & Cable
Wire/Cable Type	Regular Wire
Wire Stop	No
Insertion Force	Normal
Sealable	No

Configuration Features

Connection Capacity	Single
---------------------	--------

Contact Features

Quick Disconnect Terminal Type	Receptacle
Mating Tab Width	6.35 mm [.25 in]
Mating Tab Thickness	.81 mm [.032 in]
Terminal Orientation	Straight
Contact Base Material	Brass
Terminal Plating Material	Tin
Crimp Type	F-Crimp



Barrel Type	Open
-------------	------

Mechanical Attachment

Mating Retention Type	Dimple
-----------------------	--------

Wire Insulation Support	With
-------------------------	------

Dimensions

Accepts Wire Insulation Diameter Range	2.29 – 3.3 mm [.09 – .13 in]
--	------------------------------

Receptacle Terminal Stock Thickness	.41 mm [.016 in]
-------------------------------------	------------------

Overall Length	19.05 mm [.75 in]
----------------	-------------------

Wire Size	.32 – .82 mm ²
-----------	---------------------------

Usage Conditions

Insulation Requirement	Uninsulated
------------------------	-------------

Operating Temperature Range	-40 – 110 °C [-40 – 230 °F]
-----------------------------	-----------------------------

Industry Standards

CSA Certified	Yes
---------------	-----

UL Rating	Listed
-----------	--------

Packaging Features

Packaging Quantity	14000
--------------------	-------

Packaging Method	Strip/Reel
------------------	------------

Other

Line	Premier
------	---------

Comment	Versions according to DIN 46247, Part 3
---------	---

Product Compliance

[For compliance documentation, visit the product page on TE.com>](#)

EU RoHS Directive 2011/65/EU	Compliant
------------------------------	-----------

EU ELV Directive 2000/53/EC	Compliant
-----------------------------	-----------

China RoHS 2 Directive MIIT Order No 32, 2016	No Restricted Materials Above Threshold
---	---

EU REACH Regulation (EC) No. 1907/2006	Current ECHA Candidate List: JAN 2022 (223) Candidate List Declared Against: JAN 2022 (223) Does not contain REACH SVHC
--	---

Halogen Content	Low Halogen - Br, Cl, F, I < 900 ppm per homogenous material. Also BFR/CFR/PVC
-----------------	--

Free

Solder Process Capability

Not applicable for solder process capability

Product Compliance Disclaimer

This information is provided based on reasonable inquiry of our suppliers and represents our current actual knowledge based on the information they provided. This information is subject to change. The part numbers that TE has identified as EU RoHS compliant have a maximum concentration of 0.1% by weight in homogenous materials for lead, hexavalent chromium, mercury, PBB, PBDE, DBP, BBP, DEHP, DIBP, and 0.01% for cadmium, or qualify for an exemption to these limits as defined in the Annexes of Directive 2011/65/EU (RoHS2). Finished electrical and electronic equipment products will be CE marked as required by Directive 2011/65/EU. Components may not be CE marked. Additionally, the part numbers that TE has identified as EU ELV compliant have a maximum concentration of 0.1% by weight in homogenous materials for lead, hexavalent chromium, and mercury, and 0.01% for cadmium, or qualify for an exemption to these limits as defined in the Annexes of Directive 2000/53/EC (ELV). Regarding the REACH Regulation, the information TE provides on SVHC in articles for this part number is based on the latest European Chemicals Agency (ECHA) 'Guidance on requirements for substances in articles' posted at this URL: <https://echa.europa.eu/guidance-documents/guidance-on-reach>

Compatible Parts

TE Part # 737439-2
250 FASTON REC 22-18 AWG TPBR

TE Part # 735209-2
250 FASTON REC 22-18 AWG TPBR

TE Part # 575046-1
DAHT 250 FASTON 22-14 ASSY

TE Part # 91514-1
CCII FASTON 250 REC 22-18 ASSY

TE Part # 170181-4
205 FASTON,REC.,22-18 AWG,BR

TE Part # 2-2150030-1
OCEAN_2.0_Applicator-E-090F130F

TE Part # 2-2150030-2
OCEAN_2.0_Applicator-E-090F130F

TE Part # 2150030-1
OCEAN_2.0_Applicator-E-090F130F

TE Part # 2150030-2
OCEAN_2.0_Applicator-E-090F130F

TE Part # 7-2150030-1
OCEAN_2.0_Applicator-E-090F130F

TE Part # 7-2150030-2
OCEAN_2.0_Applicator-E-090F130F

TE Part # 7-2150030-7
OCEAN_2.0_SPARE_PART_KIT-090F130F

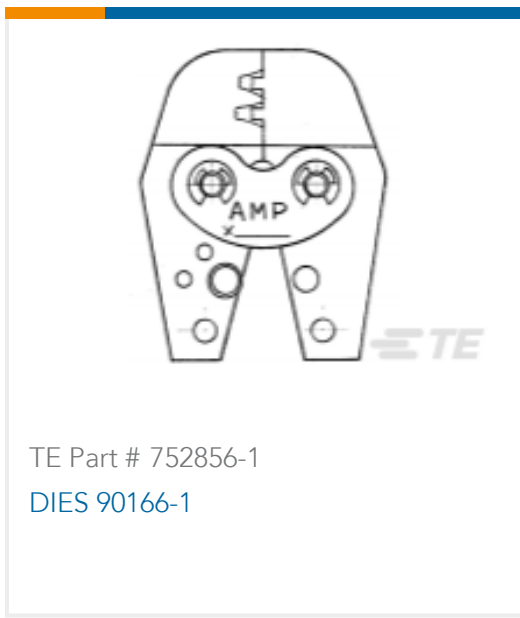

Also in the Series | **FASTON 250**

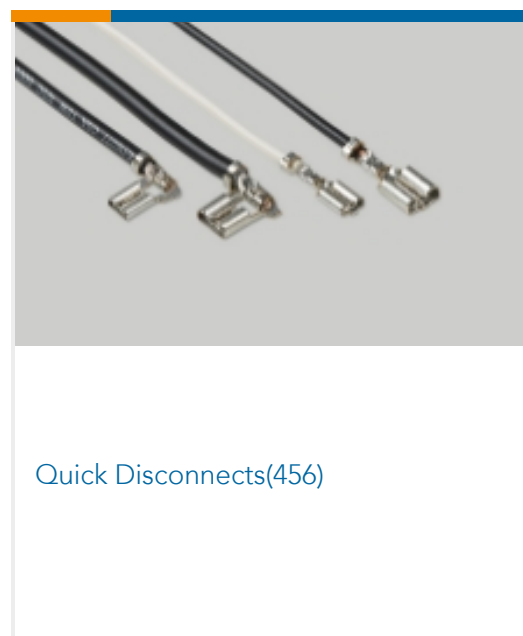
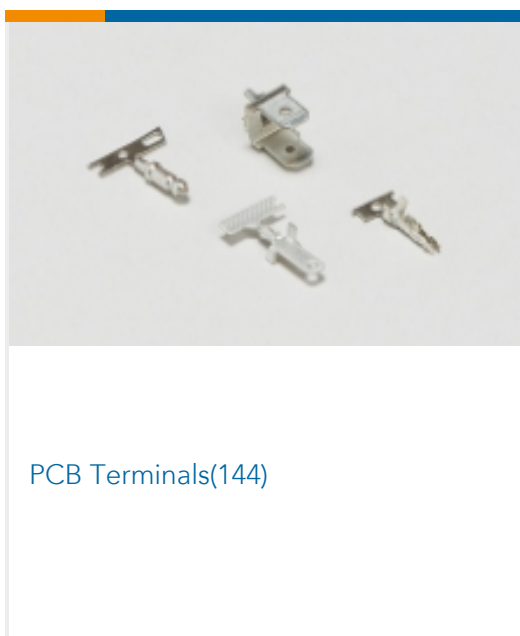
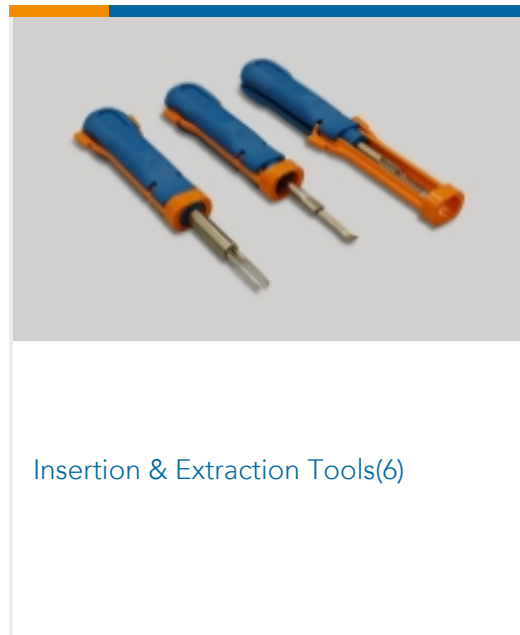
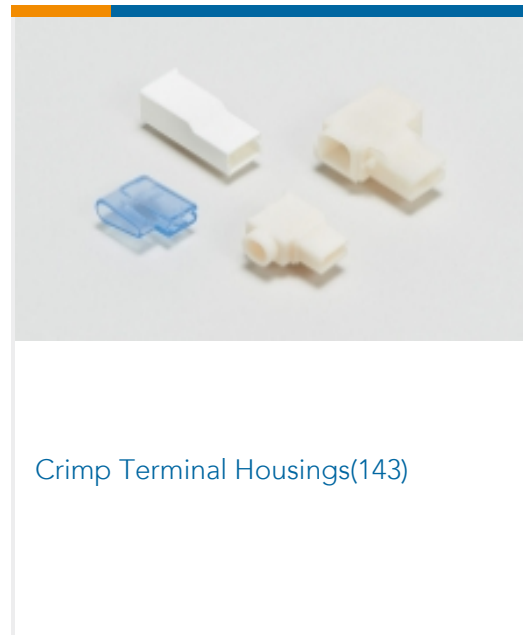
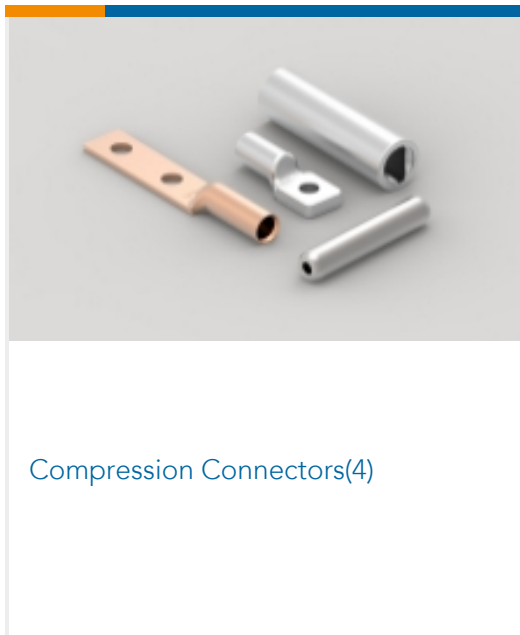

Customers Also Bought

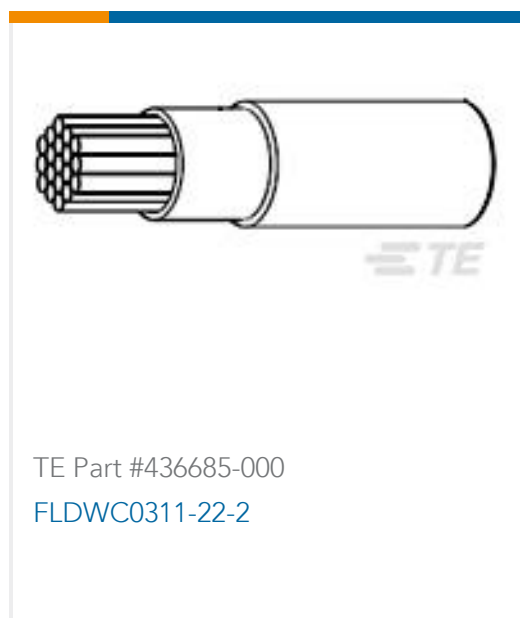



Documents

Product Drawings

250 FASTON REC 22-18 AWG BR

English

CAD Files

3D PDF

3D

Customer View Model

[ENG_CVM_CVM_41772-1_CT.2d_dxf.zip](#)

English

Customer View Model

[ENG_CVM_CVM_41772-1_CT.3d_igs.zip](#)

English

Customer View Model

[ENG_CVM_CVM_41772-1_CT.3d_stp.zip](#)

English

By downloading the CAD file I accept and agree to the [Terms and Conditions](#) of use.

Datasheets & Catalog Pages

1654742_HOUSEHOLD_APPLIANCES_RAST5

English

Product Specifications

Application Specification

English

Product Environmental Compliance

Product Compliance

English

Product Compliance

English

Agency Approvals

Agency Approval Document

English