

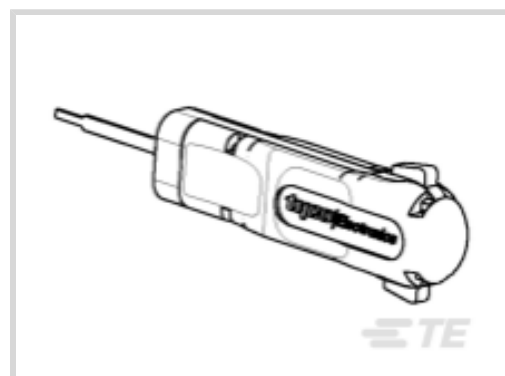

Application Tooling > Insertion & Extraction Tools



Insertion & Extraction Tool Type: **Contact Extraction**

Insertion & Extraction Tool Application: **Contact-to-Wire**

## Features

### Product Type Features

Insertion & Extraction Tool Type	Contact Extraction
Insertion & Extraction Tool Application	Contact-to-Wire

## Product Compliance

[For compliance documentation, visit the product page on TE.com>](#)

EU RoHS Directive 2011/65/EU	Compliant
EU ELV Directive 2000/53/EC	Out of Scope
China RoHS 2 Directive MIIT Order No 32, 2016	No Restricted Materials Above Threshold
EU REACH Regulation (EC) No. 1907/2006	Current ECHA Candidate List: JUNE 2022 (224) Candidate List Declared Against: JUN 2020 (209) SVHC > Threshold: Pb (3% in Component Part) <b>Article Safe Usage Statements:</b> Do not eat, drink or smoke when using this product. Wash thoroughly after handling. Recycle if possible and dispose of the article by following all applicable governmental regulations relevant to your geographic location.
Halogen Content	Low Halogen - Br, Cl, F, I < 900 ppm per homogenous material. Also BFR/CFR/PVC Free
Solder Process Capability	Not applicable for solder process capability

### Product Compliance Disclaimer

This information is provided based on reasonable inquiry of our suppliers and represents our current actual knowledge based on the information they provided. This information is subject to change. The part numbers that TE has identified as EU RoHS compliant have a maximum concentration of 0.1% by weight in homogenous materials for lead, hexavalent chromium, mercury, PBB, PBDE, DBP, BBP, DEHP, DIBP, and 0.01% for cadmium, or qualify for an exemption to these limits as defined in the Annexes of Directive 2011/65/EU (RoHS2). Finished electrical and electronic equipment products

will be CE marked as required by Directive 2011/65/EU. Components may not be CE marked. Additionally, the part numbers that TE has identified as EU ELV compliant have a maximum concentration of 0.1% by weight in homogenous materials for lead, hexavalent chromium, and mercury, and 0.01% for cadmium, or qualify for an exemption to these limits as defined in the Annexes of Directive 2000/53/EC (ELV). Regarding the REACH Regulation, the information TE provides on SVHC in articles for this part number is based on the latest European Chemicals Agency (ECHA) 'Guidance on requirements for substances in articles' posted at this URL: <https://echa.europa.eu/guidance-documents/guidance-on-reach>

## Compatible Parts



TE Part # CAT-M8793-T273  
MQS, RECEPTACLE AND TAB



TE Part # 965412-1  
MQS GRIFFSCHALE 6P



TE Part # 1355881-2  
MQS GRIFFSCHALE 6P

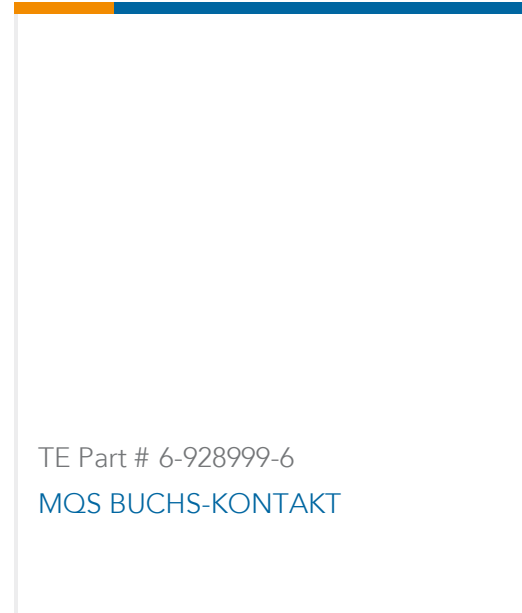

TE Part # 6-928999-6  
MQS BUCHS-KONTAKT

## Also in the Series | MQS



Automotive Connector Caps & Covers (132)

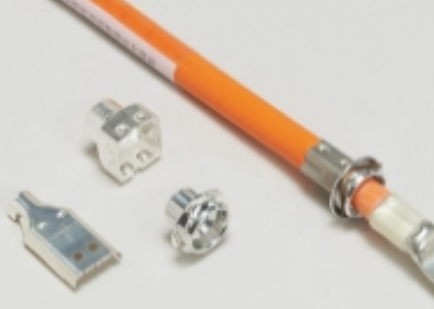

Automotive Connector EMC Shielding (2)



Automotive Connector Locks & Position Assurance(29)



Automotive Housings(489)



Automotive Seals & Cavity Plugs(26)



Automotive Terminals(96)



Insertion & Extraction Tools(42)



Other Automotive Connector Accessories(13)



PCB Headers & Receptacles(207)

## Customers Also Bought



TE Part #5-1579007-3  
EXTRACTION TOOL



TE Part #1633965-2  
CRIMPER, INSUL O PREMIUM



TE Part #1-1579018-4  
EXTRACTION TOOL



TE Part #8-1579008-4  
EXTRACTION TOOL



TE Part #1-456402-7  
CRIMPER WIRE .055 F



TE Part #1-1338690-1  
ANVIL, COMBINATION .055



TE Part #1-1673600-0  
CRIMPER, WIRE (.050" 'F')



TE Part #1333204-4  
ANVIL



TE Part #3-1333225-9  
ANVIL, COMB., SPECIAL



TE Part #6-1333201-7  
ANVIL, COMBINATION .055

## Documents

[Product Drawings](#)  
[EXTRACTION TOOL](#)

English

[Datasheets & Catalog Pages](#)  
[CRIMPING TERMINALS](#)

English

[CRIMPING WHERE FORM MEETS FUNCTION](#)

English