

Potentiometer, compact, 22 mm, round, plastic, black, 4.7k ohm, with holder, screw terminal



Product brand name	SIRIUS ACT
Product designation	Potentiometers
Design of the product	Compact unit
Product type designation	3SU1
Manufacturer's article number	
• of the supplied holder	<a href="#">3SU1500-0AA10-0AA0</a>

## Enclosure

Number of command points	1
--------------------------	---

## Actuator

Design of the operating mechanism	Rotary knob
Manner of function of the actuating element	Infinitely variable adjustment, angle of rotation 280°
Color	
• of the actuating element	black
Material of the actuating element	plastic
Shape of the actuating element	round
Outer diameter of the actuating element	30 mm
Maximum deflection angle [°]	280°

## Front ring

<b>Product component front ring</b>	No
-------------------------------------	----

### Holder

<b>Material of the holder</b>	Plastic
-------------------------------	---------

### General technical data

<b>Insulation voltage</b>	
• rated value	500 V
<b>Degree of pollution</b>	3
<b>Protection class IP</b>	IP66, IP67, IP69(IP69K)
• of the terminal	IP20
<b>Degree of protection NEMA rating</b>	NEMA 1, 2, 3, 3R, 4, 4X, 12, 13
<b>Shock resistance</b>	
• acc. to IEC 60068-2-27	Sinusoidal half-wave 50 g / 11 ms
• for railway applications acc. to DIN EN 61373	Category 1, Class B
<b>Mechanical service life (switching cycles)</b>	
• typical	25 000
<b>Reference code acc. to DIN EN 81346-2</b>	S
<b>Reference code acc. to DIN EN 61346-2</b>	S

### Connections/Terminals

<b>Type of electrical connection</b>	screw-type terminals
<b>Type of connectable conductor cross-sections</b>	
• solid with core end processing	2x (0.5 ... 0.75 mm <sup>2</sup> )
• solid without core end processing	2x (1.0 ... 1.5 mm <sup>2</sup> )
• finely stranded with core end processing	2x (0.5 ... 1.5 mm <sup>2</sup> )
• finely stranded without core end processing	2x (1,0 ... 1,5 mm <sup>2</sup> )
• at AWG conductors	2x (18 ... 14)
<b>Tightening torque of the screws in the bracket</b>	1 ... 1.2 N·m
<b>Tightening torque</b>	
• with screw-type terminals	0.8 ... 1 N·m

### Ambient conditions





<b>Ambient temperature</b>	
• during operation	-25 ... +70 °C
• during storage	-40 ... +80 °C
Environmental category during operation acc. to IEC 60721	3M6, 3S2, 3B2, 3C3, 3K6 (with relative air humidity of 10 ... 95 %, no condensation in operation permitted for all devices behind front panel)

### Installation/ mounting/ dimensions

<b>Height</b>	40 mm
<b>Width</b>	30 mm
<b>Shape of the installation opening</b>	round
<b>Mounting diameter</b>	22.3 mm
<b>Positive tolerance of installation diameter</b>	0.4 mm

Mounting height	19.4 mm
Installation width	30 mm
Installation depth	46 mm

#### Certificates/approvals

General Product Approval		Declaration of Conformity		Test Certificates
 CSA	 UL		 EG-Konf.	<a href="#">Miscellaneous</a> <a href="#">Special Test Certificate</a>

Test Certificates	other
<a href="#">Type Test Certificates/Test Report</a>	<a href="#">Confirmation</a>

#### Further information

**Information- and Downloadcenter (Catalogs, Brochures,...)**

<http://www.siemens.com/industrial-controls/catalogs>

**Industry Mall (Online ordering system)**

<https://mall.industry.siemens.com/mall/en/en/Catalog/product?mlfb=3SU1200-2PR10-1AA0>

**Cax online generator**

<http://support.automation.siemens.com/WW/CAXorder/default.aspx?lang=en&mlfb=3SU1200-2PR10-1AA0>

**Service&Support (Manuals, Certificates, Characteristics, FAQs,...)**

<https://support.industry.siemens.com/cs/ww/en/ps/3SU1200-2PR10-1AA0>

**Image database (product images, 2D dimension drawings, 3D models, device circuit diagrams, EPLAN macros, ...)**

[http://www.automation.siemens.com/bilddb/cax\\_de.aspx?mlfb=3SU1200-2PR10-1AA0&lang=en](http://www.automation.siemens.com/bilddb/cax_de.aspx?mlfb=3SU1200-2PR10-1AA0&lang=en)

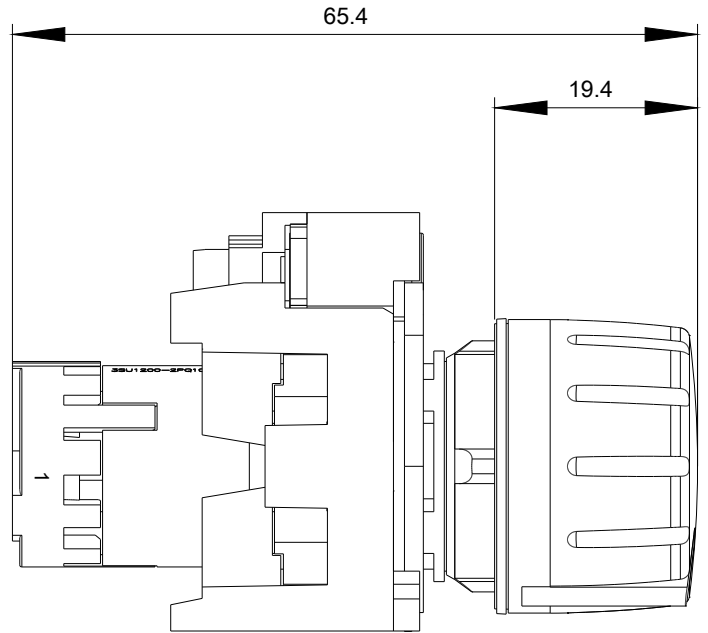
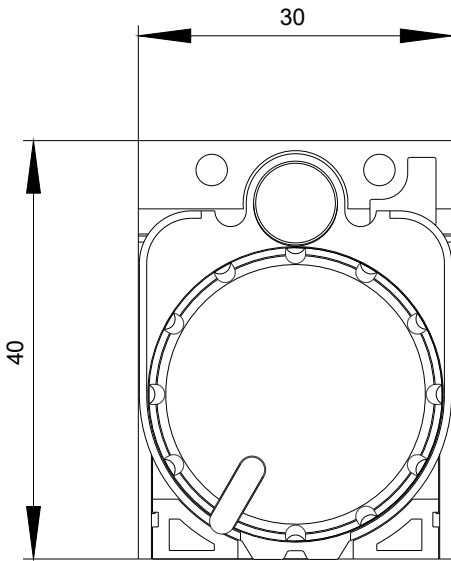

$-R$   
4.7 kOhm

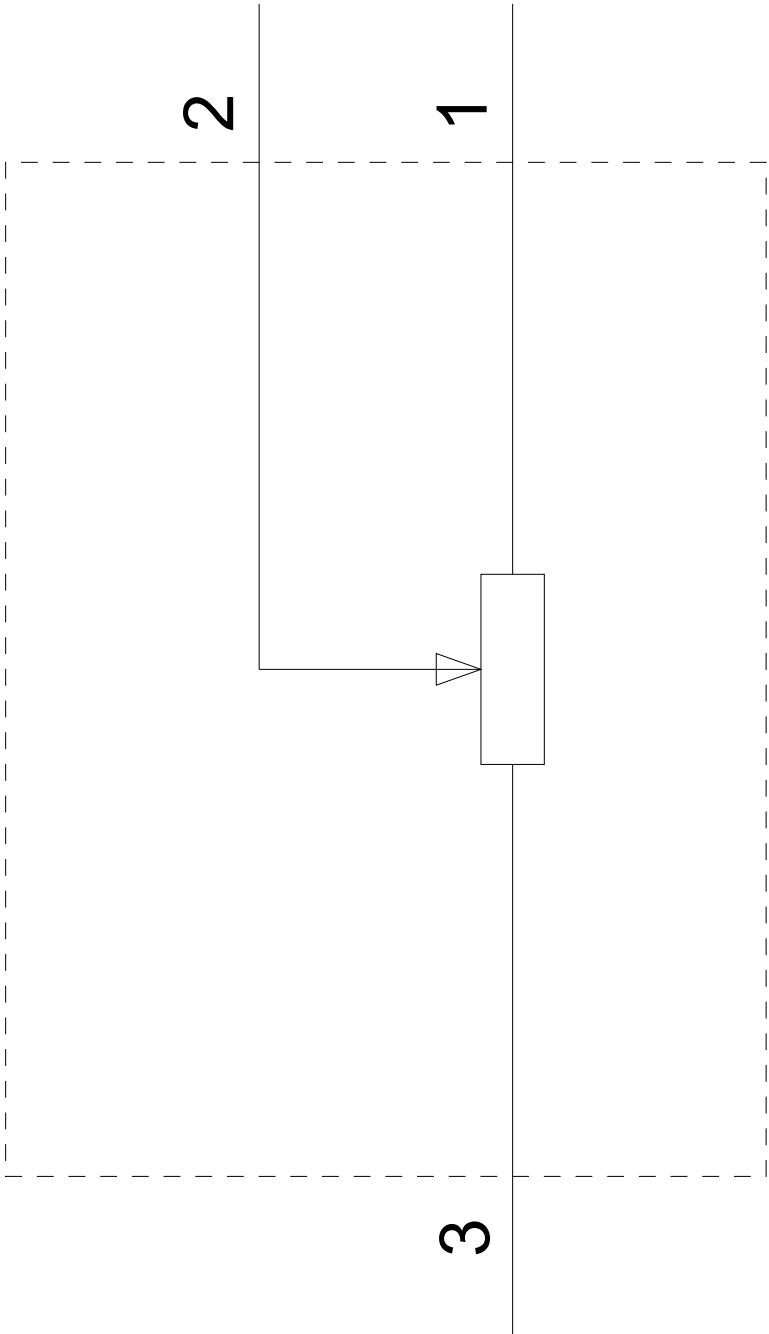

last modified:

02/21/2019