

Position switch Plastic enclosure 40 mm according to EN 50041
 Device connection 1 x (M20 x 1.5) 1 NO/1 NC quick action contacts
 Rotary actuator right/left adjustable, Rod lever made of aluminum
 200 mm long



Product brand name	SIRIUS
Product designation	Mechanical position switches
Product type designation	3SE5
Manufacturer's article number	<ul style="list-style-type: none"> • of the supplied basic switch 3SE5132-0CA00 • of the supplied actuator head for position switches 3SE5000-0AJ00 • of the supplied operating lever 3SE5000-0AA80 • of the supplied switching contacts 3SE5000-0CA00 • of the supplied empty enclosure with cover 3SE5132-0AA00
Suitability for use safety switch	No

General technical data	
Product function	
<ul style="list-style-type: none"> • positive opening 	No
Insulation voltage	
<ul style="list-style-type: none"> • rated value 	400 V
Degree of pollution	class 3
Surge voltage resistance rated value	6 kV
Protection class IP	IP65/IP67

Shock resistance	
<ul style="list-style-type: none"> • acc. to IEC 60068-2-27 	30 g / 11 ms
Vibration resistance	
<ul style="list-style-type: none"> • acc. to IEC 60068-2-6 	0.35 mm/5g
Mechanical service life (switching cycles)	
<ul style="list-style-type: none"> • typical 	15 000 000
Electrical endurance (switching cycles)	
<ul style="list-style-type: none"> • at AC-15 at 230 V typical 	100 000
Electrical endurance (switching cycles) with contactor 3RH11, 3RT1016, 3RT1017, 3RT1024, 3RT1025, 3RT1026 typical	10 000 000
Electrical operating cycles in one hour with contactor 3RH11, 3RT1016, 3RT1017, 3RT1024, 3RT1025, 3RT1026	6 000
Thermal current	10 A
Material of the enclosure of the switch head	plastic
Continuous current of the C characteristic MCB	1 A; for a short-circuit current smaller than 400 A
Continuous current of the quick DIAZED fuse link	10 A; for a short-circuit current smaller than 400 A
Continuous current of the DIAZED fuse link gG	6 A
Active principle	mechanical
Repeat accuracy	0.05 mm
Minimum actuating torque in activation direction	0.25 N·m
Length of the sensor	281 mm
Width of the sensor	40 mm
Design of the switching contact	mechanical
Operating frequency rated value	50 ... 60 Hz
Number of NC contacts for auxiliary contacts	1
Number of NO contacts for auxiliary contacts	1
Number of CO contacts for auxiliary contacts	1
Operating current at AC-15	
<ul style="list-style-type: none"> • at 24 V rated value • at 125 V rated value • at 240 V rated value • at 400 V rated value 	6 A 6 A 6 A 4 A
Operating current at DC-13	
<ul style="list-style-type: none"> • at 24 V rated value • at 125 V rated value • at 250 V rated value • at 400 V rated value 	3 A 0.55 A 0.27 A 0.12 A
Design of the interface for safety-related communication	without
Enclosure	
Design of the housing	block, narrow

Material of the enclosure	plastic
Coating of the enclosure	Other types
Design of the housing acc. to standard	Yes

Drive Head

Design of the operating mechanism	Rod lever, aluminum rod, length 200 mm
Standard-compliant actuator head	EN 50041, design D
Shape of the switch head	roller
Circuit principle	snap-action contacts
Number of switching contacts safety-related	0

Connections/Terminals

Type of electrical connection	screw-type terminals
Type of connectable conductor cross-sections	
<ul style="list-style-type: none"> • solid • finely stranded with core end processing • at AWG conductors solid • at AWG conductors stranded 	1x (0.5 ... 1.5 mm ²), 2x (0.5 ... 0.75 mm ²) 1x (0.5 ... 1.5 mm ²), 2x (0.5 ... 0.75 mm ²) 1x (20 ... 16), 2x (20 ... 18) 1x (20 ... 16), 2x (20 ... 18)
Cable entry type	1x (M20 x 1.5)

Communication/ Protocol

Design of the interface	without
-------------------------	---------





Ambient conditions

Ambient temperature	
<ul style="list-style-type: none"> • during operation • during storage 	-25 ... +85 °C -40 ... +90 °C
Explosion protection category for dust	none

Installation/ mounting/ dimensions

Mounting position	any
Mounting type	screw fixing

Certificates/approvals

General Product Approval	Functional Safety/Safety of Machinery	Declaration of Conformity	other
 CCC	 CSA	 EAC	Type Examination Certificate  EG-Konf.

Further information

Information- and Downloadcenter (Catalogs, Brochures,...)
<http://www.siemens.com/industrial-controls/catalogs>

Industry Mall (Online ordering system)
<https://mall.industry.siemens.com/mall/en/en/Catalog/product?mlfb=3SE5132-0CJ80>

Cax online generator

<http://support.automation.siemens.com/WW/CAXorder/default.aspx?lang=en&mlfb=3SE5132-0CJ80>

Service&Support (Manuals, Certificates, Characteristics, FAQs,...)

<https://support.industry.siemens.com/cs/ww/en/ps/3SE5132-0CJ80>

Image database (product images, 2D dimension drawings, 3D models, device circuit diagrams, EPLAN macros, ...)

http://www.automation.siemens.com/bilddb/cax_de.aspx?mlfb=3SE5132-0CJ80&lang=en

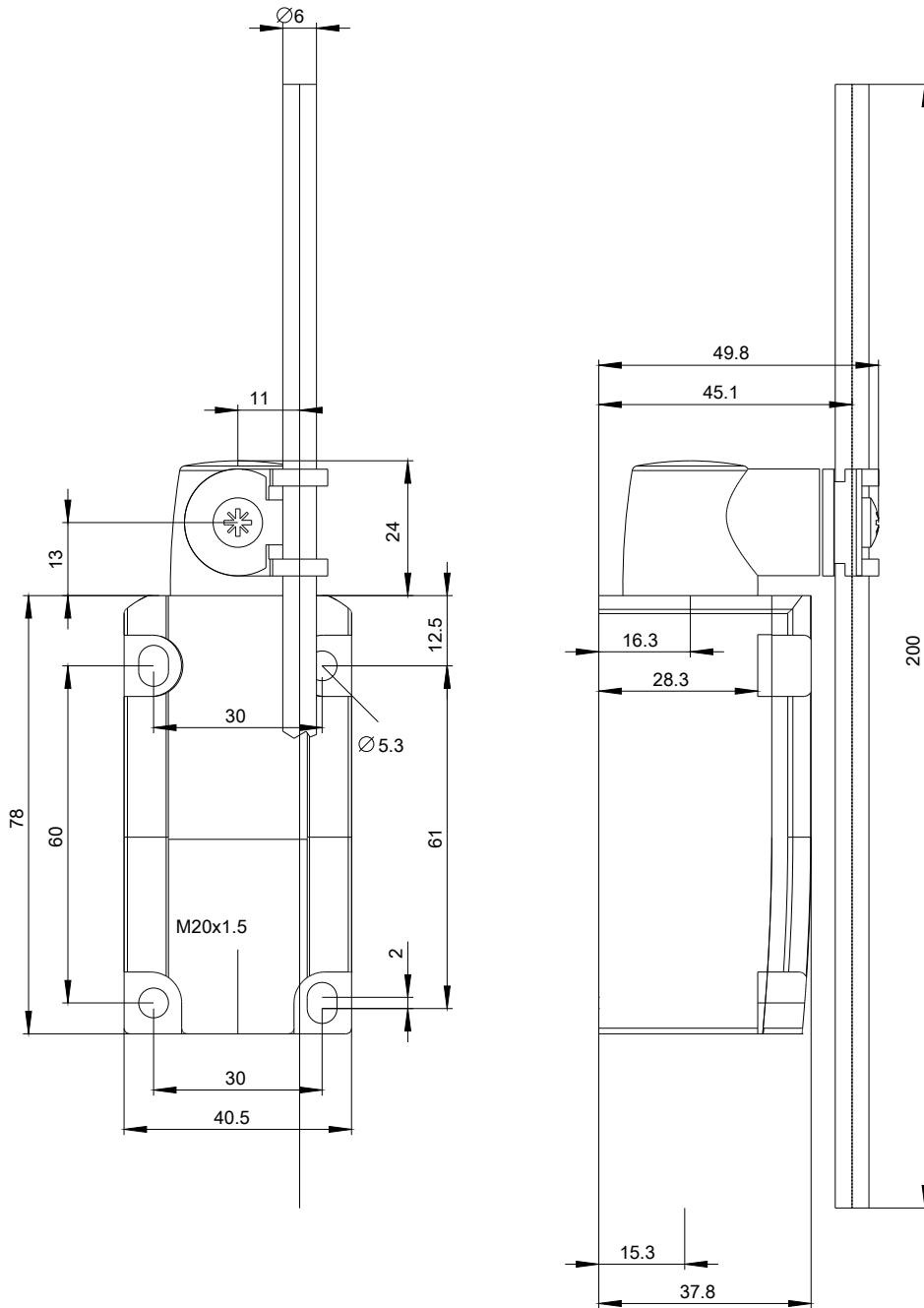

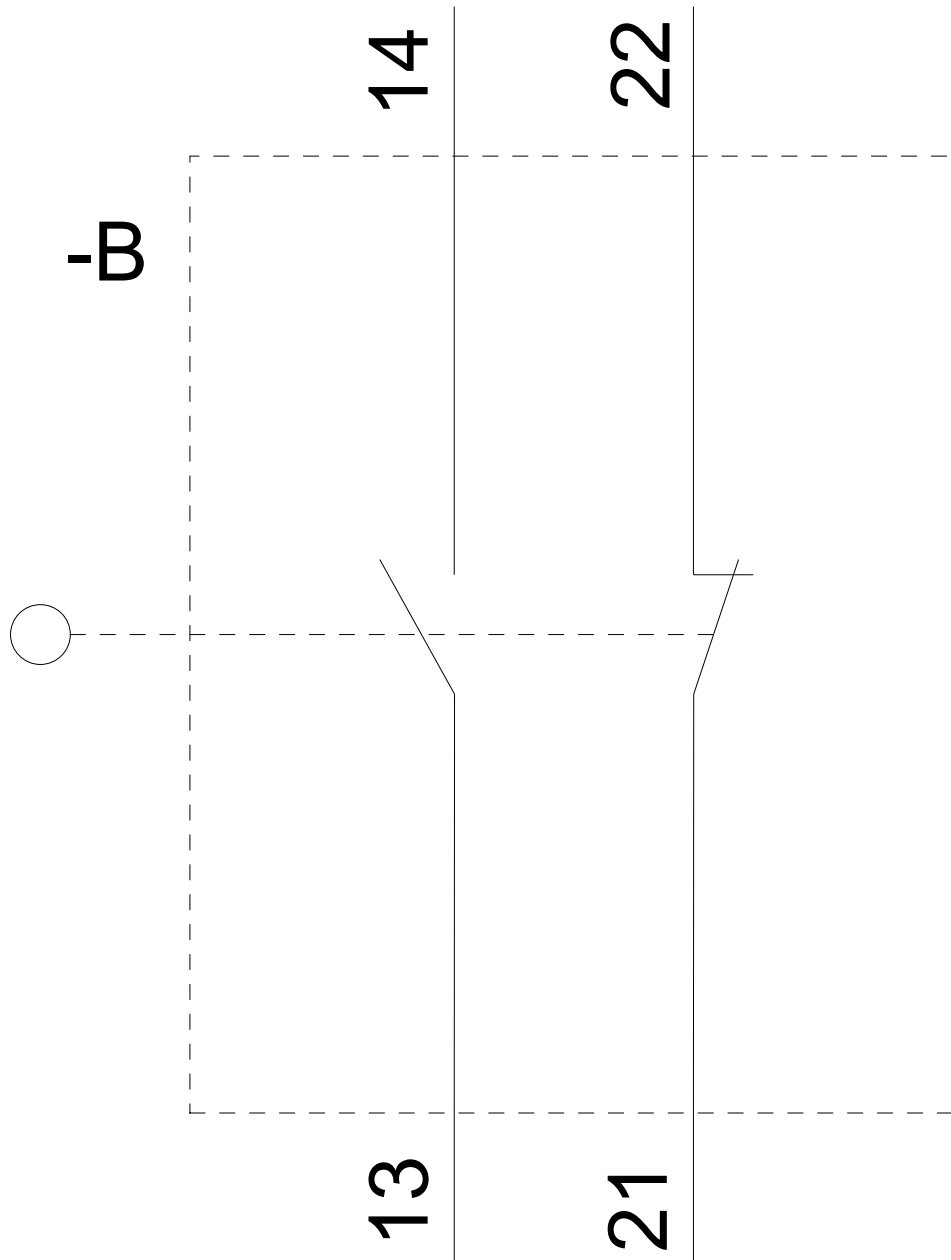

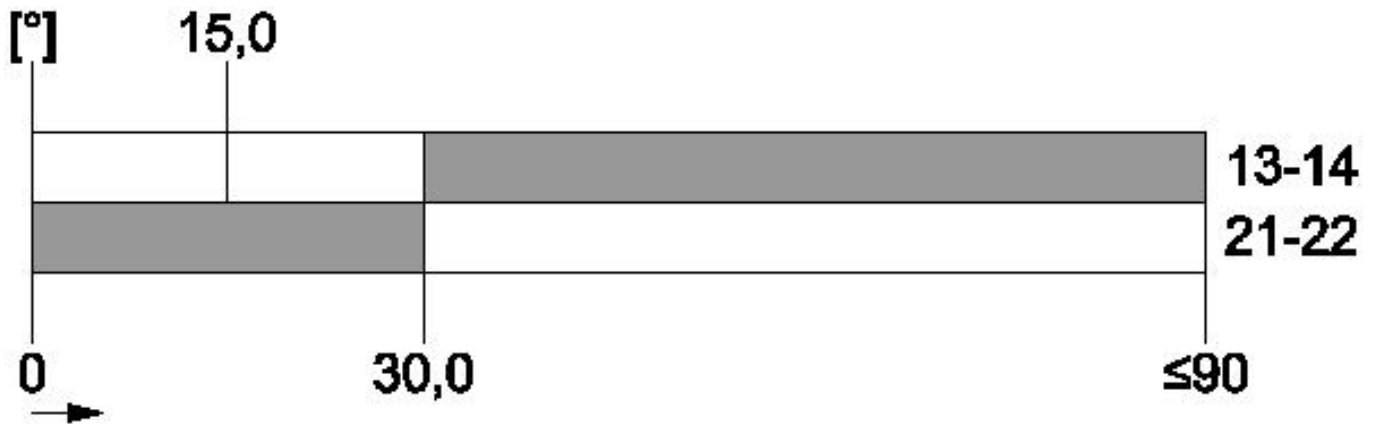

last modified:

11/17/2018