

PLEASE CHECK WWW.MOLEX.COM FOR LATEST PART INFORMATION

Part Number: [0039532094](#)
Status: **Active**
Overview: Easy-On FFC FPC Connectors
Description: 1.25mm Pitch Easy-On FFC/FPC Connector, Through-Hole, Right-Angle, ZIF, Top Contact Style, 9 Circuits

Documents:

3D Model	Product Specification PS-5597-004-001 (PDF)
3D Model (PDF)	Packaging Specification SPK-5597-003-001 (PDF)
Drawing (PDF)	RoHS Certificate of Compliance (PDF)

Agency Certification

UL E29179

General

Product Family	FFC/FPC Connectors
Series	5597
Overview	Easy-On FFC FPC Connectors
Product Name	Easy-On
UPC	822348170166

Physical

Actuator Type	Slider
Circuits (Loaded)	9
Circuits (maximum)	9
Color - Resin	Natural
Contact Position	Top
Durability (mating cycles max)	30
Flammability	94V-0
Mated Height	5.00mm
Material - Metal	Phosphor Bronze
Material - Plating Mating	Tin-Bismuth
Material - Plating Termination	Tin-Bismuth
Material - Resin	Polyester
Net Weight	884.090/mg
Number of Rows	1
Orientation	Right Angle
PC Tail Length	3.50mm
PCB Locator	No
PCB Mounting	Through Hole
PCB Retention	None
Packaging Type	Tray
Pitch - Mating Interface	1.25mm
Plating min - Mating	1.016µm
Plating min - Termination	1.016µm
Polarized to PCB	No
Stackable	No
Surface Mount Compatible (SMC)	No
Temperature Range - Operating	-20° to +80°C
Wire/Cable Type	FFC/FPC

Electrical

Current - Maximum per Contact	1.0A
Voltage - Maximum	200V

Material Info

Engineering Number 5597-09APB7F

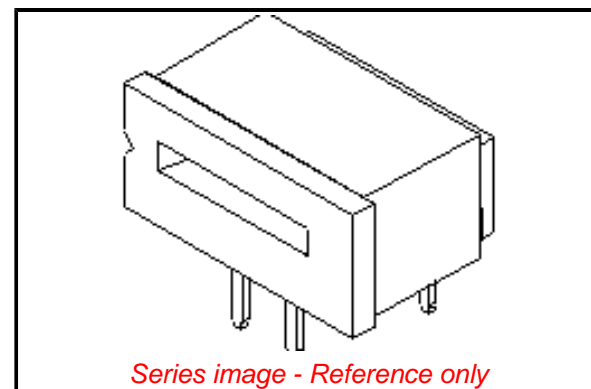

EU ELV

Not Relevant

EU RoHS

Compliant

REACH SVHC

Not Contained Per -
D(2021)10043-DC (17
Jan 2022)

Halogen-Free

Status

Not Low-Halogen

For more information, please visit [Contact US](#)

China ROHS

ELV

RoHS Phthalates

China RoHS

Green Image

Not Relevant

Not Contained

Search Parts in this Series

[5597 Series](#)

Reference - Drawing Numbers

Packaging Specification

Product Specification

Sales Drawing

SPK-5597-003-001

PS-5597-004-001

SD-5597-011-001

This document was generated on 04/18/2022

PLEASE CHECK WWW.MOLEX.COM FOR LATEST PART INFORMATION