

342101-1 ✓ ACTIVE

PLASTI-GRIP

TE Internal #: 342101-1

Ring Terminals & Spade Terminals, Ring Tongue, 22 – 16 AWG

Wire Size, .3 – 1.3 mm² Wire Size, Stud Size M2.5, Stud Diameter

3.02 mm [.119 in]

[View on TE.com >](#)



Terminals & Splices > Ring Terminals & Spade Terminals

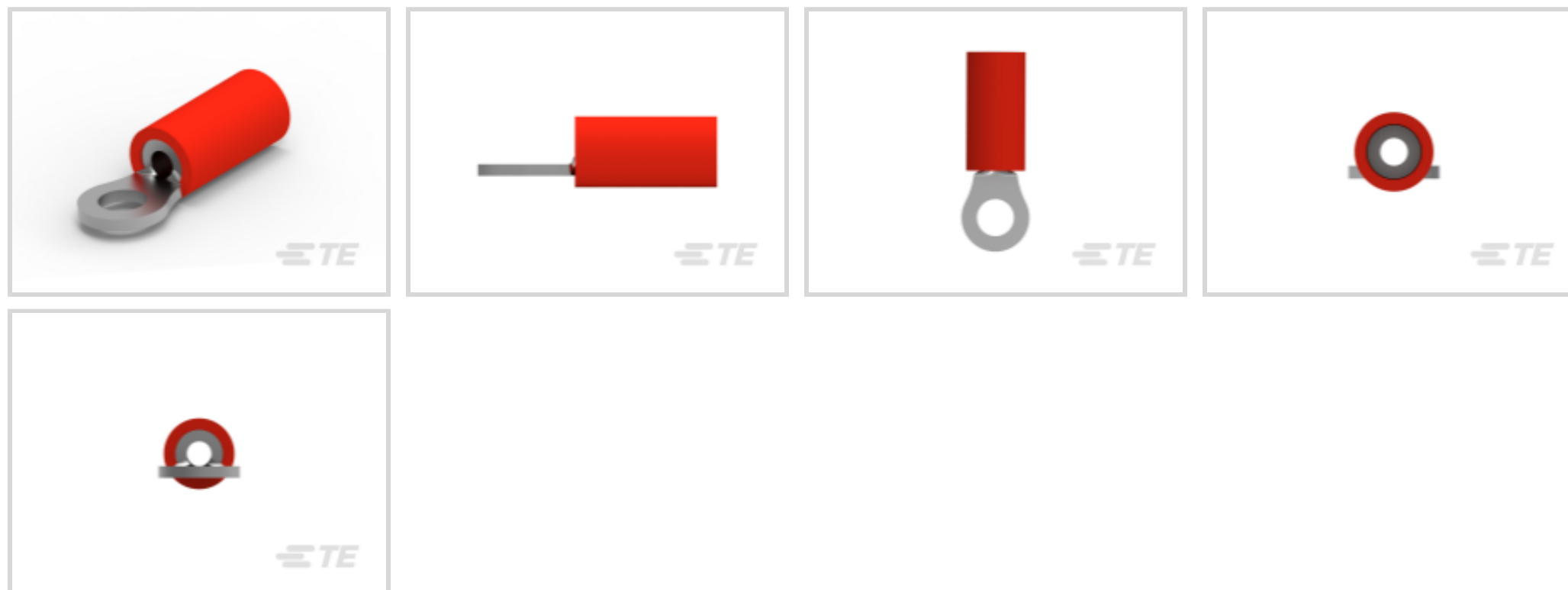

Ring & Spade Terminal Type: **Ring Tongue**

Wire Size: **.3 – 1.3 mm²**

Stud Size: **M2.5**

Stud Diameter: **3.02 mm [.119 in]**

Features

Product Type Features

Terminal Features	Sheared
Shape Description	RING-043
Stud Size	M2.5
Sealable	No
Wire Insulation Support Retention Type	Insulation Support

Configuration Features

Number of Holes	1
Terminal Angle	180 °

Electrical Characteristics

Voltage (Max)	600 V
---------------	-------

Body Features

Inspection Slot	No
Insulation Sleeve Color	Red
Weight per Piece	.748 g



Stripe Color	Red
--------------	-----

Contact Features

Ring & Spade Terminal Type	Ring Tongue
Barrel Type	Closed
Terminal Orientation	Offset
Terminal Plating Material	Tin

Mechanical Attachment

Wire Insulation Support	Without
-------------------------	---------

Dimensions

Wire Size	.3 – 1.3 mm ²
Stud Diameter	3.02 mm [.119 in]
Tongue Thickness	.79 mm [.031 in]
Overall Product Length	17.5 mm [.689 in]
Accepts Wire Insulation Diameter (Max)	3.6 mm [.141 in]
Accepts Wire Insulation Diameter Range	2.7 – 3.6 mm [.106 – .142 in]

Usage Conditions

Insulation Requirement	Partially Insulated
Operating Temperature Range	105 °C [221 °F]

Operation/Application

Compatible With Wire Base Material	Copper
Compatible With Wire Plating Material	Tin
Heavy Duty	No

Industry Standards

Government Qualified	No
----------------------	----

Packaging Features

Packaging Quantity	100
Packaging Method	Loose Piece

Product Compliance

[For compliance documentation, visit the product page on TE.com>](#)









EU RoHS Directive 2011/65/EU	Compliant
EU ELV Directive 2000/53/EC	Compliant

China RoHS 2 Directive MIIT Order No 32, 2016	No Restricted Materials Above Threshold
EU REACH Regulation (EC) No. 1907/2006	Current ECHA Candidate List: JAN 2022 (223) Candidate List Declared Against: JUL 2021 (219) SVHC > Threshold: Not Yet Reviewed
Halogen Content	Not Low Halogen - contains Br or Cl > 900 ppm.
Solder Process Capability	Not applicable for solder process capability

Product Compliance Disclaimer

This information is provided based on reasonable inquiry of our suppliers and represents our current actual knowledge based on the information they provided. This information is subject to change. The part numbers that TE has identified as EU RoHS compliant have a maximum concentration of 0.1% by weight in homogenous materials for lead, hexavalent chromium, mercury, PBB, PBDE, DBP, BBP, DEHP, DIBP, and 0.01% for cadmium, or qualify for an exemption to these limits as defined in the Annexes of Directive 2011/65/EU (RoHS2). Finished electrical and electronic equipment products will be CE marked as required by Directive 2011/65/EU. Components may not be CE marked. Additionally, the part numbers that TE has identified as EU ELV compliant have a maximum concentration of 0.1% by weight in homogenous materials for lead, hexavalent chromium, and mercury, and 0.01% for cadmium, or qualify for an exemption to these limits as defined in the Annexes of Directive 2000/53/EC (ELV). Regarding the REACH Regulation, the information TE provides on SVHC in articles for this part number is based on the latest European Chemicals Agency (ECHA) 'Guidance on requirements for substances in articles' posted at this URL: <https://echa.europa.eu/guidance-documents/guidance-on-reach>

Compatible Parts

 <p>TE Part # 59170 T-HEAD PIDG SH 26-14 ASSY</p>	 <p>TE Part # 59824-1 TETRA-CRIMP PIDG PG FASTON 22-10 ASSY</p>	 <p>TE Part # 47386 DAHT PG PIDG 26-16 ASSY</p>	 <p>TE Part # 58433-3 PRO CR ASSY, RBY IS9252</p>
 <p>TE Part # 59250 T-HEAD PIDG 26-14 ASSY</p>	 <p>TE Part # 58423-1 DIE, RBY IS9252</p>	 <p>TE Part # 539691-2 ERGO DIE R.B.Y</p>	 <p>TE Part # 2063030-1 SDE DIESET, RBY, UL</p>



Customers Also Bought

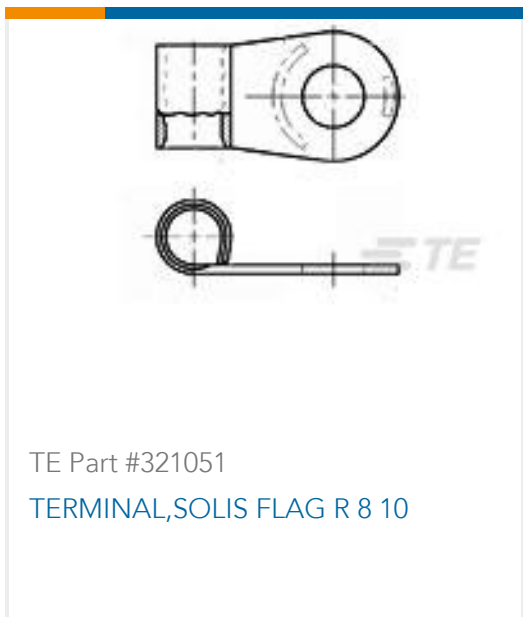

Documents



Product Drawings

22-16 F.E.P.G.RING TONGUE NO.6

English

CAD Files

3D PDF

3D

Customer View Model

[ENG_CVM_CVM_342101-1_L.2d_dxf.zip](#)

English

Customer View Model

[ENG_CVM_CVM_342101-1_L.3d_igs.zip](#)

English

Customer View Model

[ENG_CVM_CVM_342101-1_L.3d_stp.zip](#)

English

By downloading the CAD file I accept and agree to the [Terms and Conditions](#) of use.

Datasheets & Catalog Pages

RADIATION_RESISTANT_PRE-INSULATED_TERMINALS_SPLICES

English

Product Specifications

Application Specification

English

Product Environmental Compliance

Product Compliance

English

Product Compliance

English