

330648 ✓ ACTIVE



PIDG

TE Internal #: 330648

PIDG, Ring Terminals & Spade Terminals, Ring Tongue, 22 – 16 AWG Wire Size, .3 – 1.3 mm² Wire Size, 509 – 3260 CMA Wire Size, Stud Size M2.5 / #4

[View on TE.com >](#)

Terminals & Splices > Ring Terminals & Spade Terminals > PIDG RING TONGUE TERMINALS

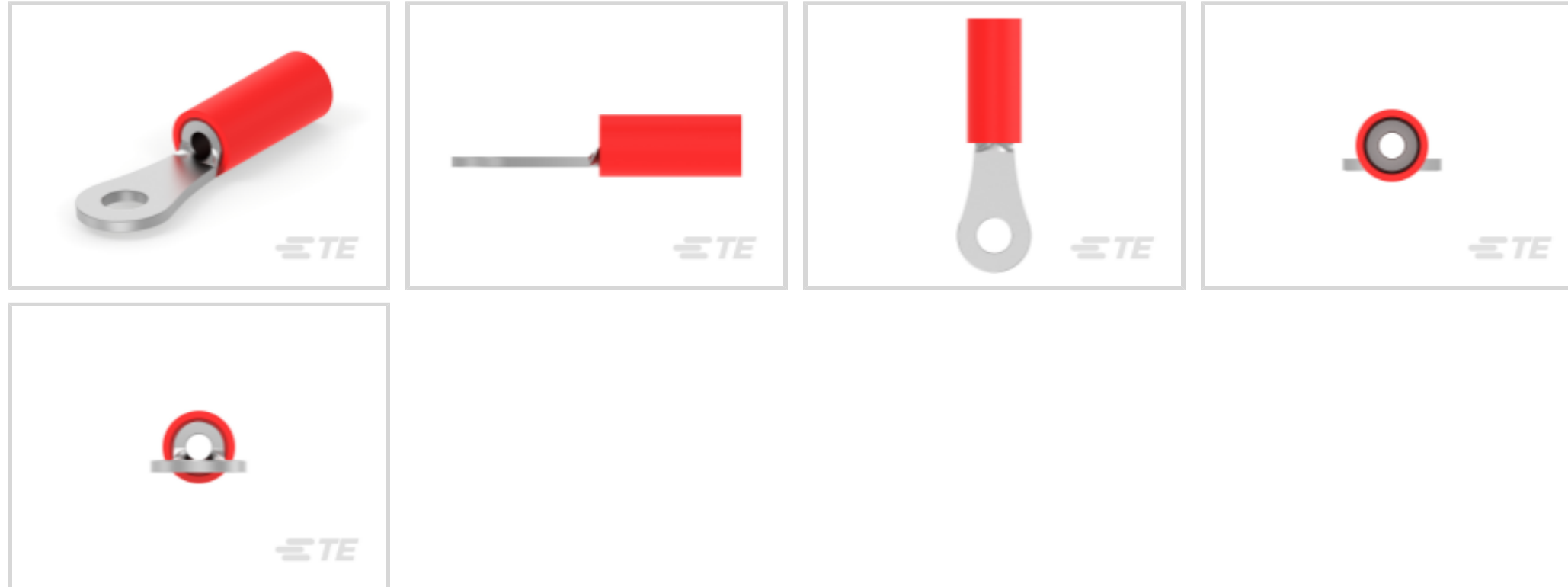

Ring & Spade Terminal Type: Ring Tongue

Wire Size: 509 – 3260 CMA

Stud Size: #4, M2.5

[All PIDG RING TONGUE TERMINALS \(422\)](#)

Features

Product Type Features

Terminal Features	Sheared
Shape Description	RING-041
Stud Size	#4, M2.5
Sealable	No
Wire Insulation Support Retention Type	Insulation Support

Configuration Features

Number of Holes	1
Terminal Angle	180 °

Electrical Characteristics

Voltage (Max)	300 V
---------------	-------

Body Features

Inspection Slot	No
Weight per Piece	.842 g

Contact Features



Ring & Spade Terminal Type	Ring Tongue
Barrel Type	Closed
Terminal Orientation	Straight
Terminal Plating Material	Tin

Mechanical Attachment

Wire Insulation Support	With
-------------------------	------

Dimensions

Wire Size	509 – 3260 CMA
Stud Diameter	3.02 mm[.119 in]
Tongue Thickness	.79 mm[.031 in]
Overall Product Length	21.44 mm[.844 in]
Accepts Wire Insulation Diameter (Max)	3.56 mm[.14 in]
Accepts Wire Insulation Diameter Range	2.67 – 3.56 mm[.105 – .14 in]

Usage Conditions

Insulation Requirement	Partially Insulated
Operating Temperature Range	105 °C[221 °F]

Operation/Application

Compatible With Wire Base Material	Copper
Compatible With Wire Plating Material	Tin
Heavy Duty	No

Industry Standards

Government Qualified	No
----------------------	----

Packaging Features

Packaging Quantity	1000
Packaging Method	Loose Piece

Product Compliance

[For compliance documentation, visit the product page on TE.com>](#)

EU RoHS Directive 2011/65/EU	Compliant
EU ELV Directive 2000/53/EC	Compliant
China RoHS 2 Directive MIIT Order No 32, 2016	No Restricted Materials Above Threshold
EU REACH Regulation (EC) No. 1907/2006	



Current ECHA Candidate List: JAN 2022

(223)

Candidate List Declared Against: JAN 2022

(223)

Does not contain REACH SVHC

Halogen Content

Low Halogen - Br, Cl, F, I < 900 ppm per homogenous material. Also BFR/CFR/PVC Free

Solder Process Capability

Not applicable for solder process capability

Product Compliance Disclaimer

This information is provided based on reasonable inquiry of our suppliers and represents our current actual knowledge based on the information they provided. This information is subject to change. The part numbers that TE has identified as EU RoHS compliant have a maximum concentration of 0.1% by weight in homogenous materials for lead, hexavalent chromium, mercury, PBB, PBDE, DBP, BBP, DEHP, DIBP, and 0.01% for cadmium, or qualify for an exemption to these limits as defined in the Annexes of Directive 2011/65/EU (RoHS2). Finished electrical and electronic equipment products will be CE marked as required by Directive 2011/65/EU. Components may not be CE marked. Additionally, the part numbers that TE has identified as EU ELV compliant have a maximum concentration of 0.1% by weight in homogenous materials for lead, hexavalent chromium, and mercury, and 0.01% for cadmium, or qualify for an exemption to these limits as defined in the Annexes of Directive 2000/53/EC (ELV). Regarding the REACH Regulation, the information TE provides on SVHC in articles for this part number is based on the latest European Chemicals Agency (ECHA) 'Guidance on requirements for substances in articles' posted at this URL: <https://echa.europa.eu/guidance-documents/guidance-on-reach>

Compatible Parts



REPRESENTATION ONLY

TE Part # 47386
DAHT PG PIDG 26-16 ASSY



REPRESENTATION ONLY

TE Part # 47386-4
DAHT PG PIDG 26-16 ASSY



TE Part # 58433-3
PRO CR ASSY, RBY IS9252



TE Part # 59250
T-HEAD PIDG 26-14 ASSY



TE Part # 58423-1
DIE, RBY IS9252



TE Part # 59824-1
TETRA-CRIMP PIDG PG FASTON 22-10 ASSY



REPRESENTATION ONLY

TE Part # 525690
DAHT PG PIDG 20-18 ASSY



TE Part # 539691-2
ERGO DIE R.B.Y



Also in the Series | PIDG

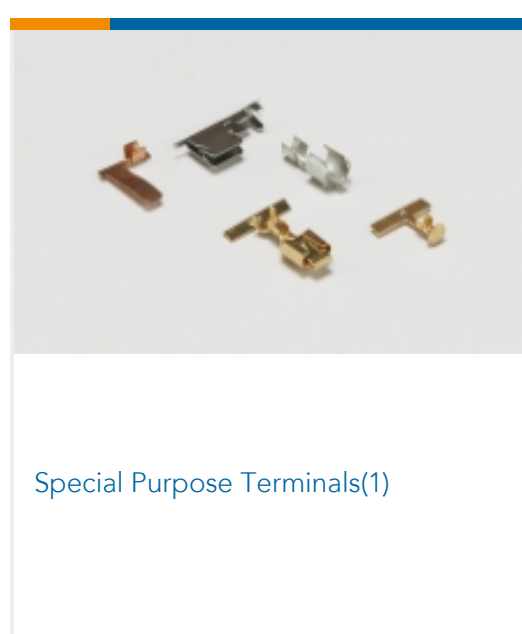
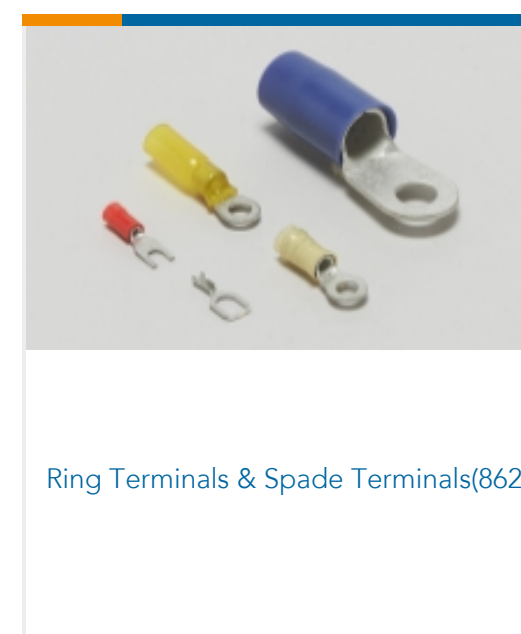
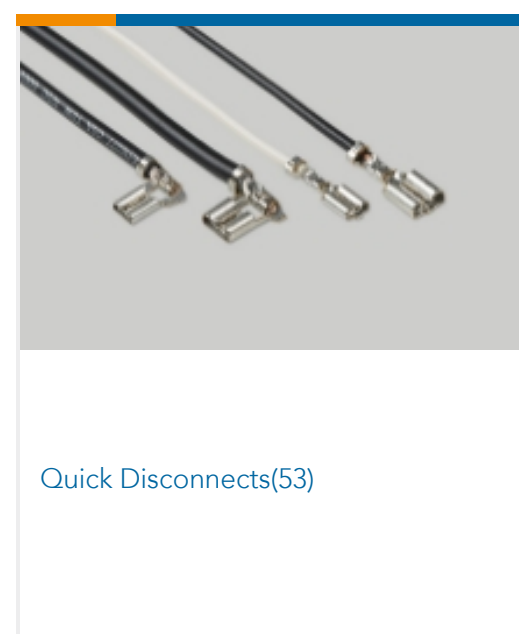
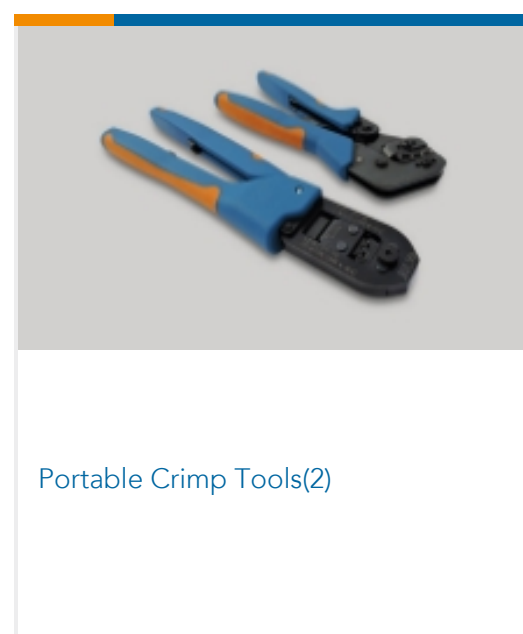
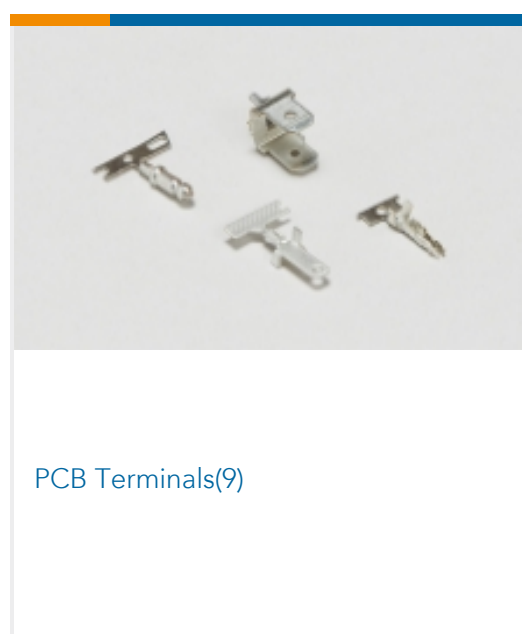
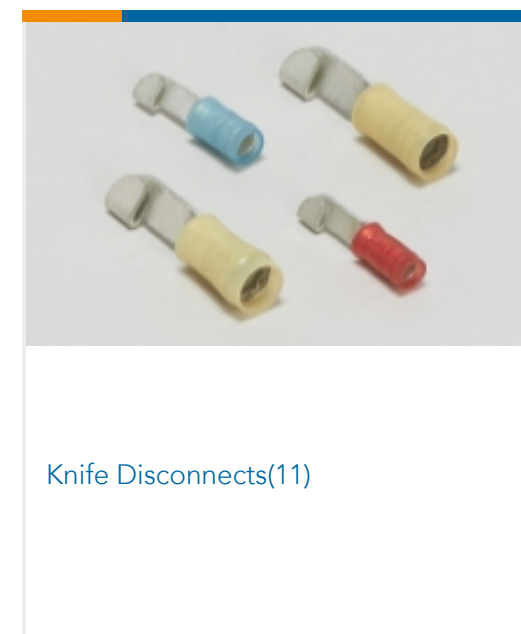
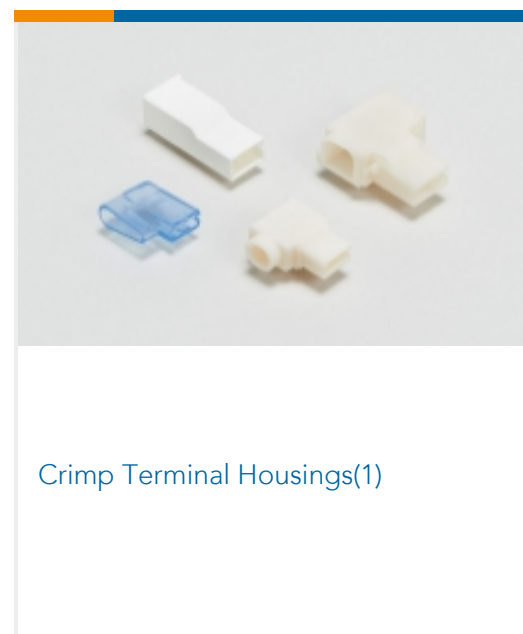
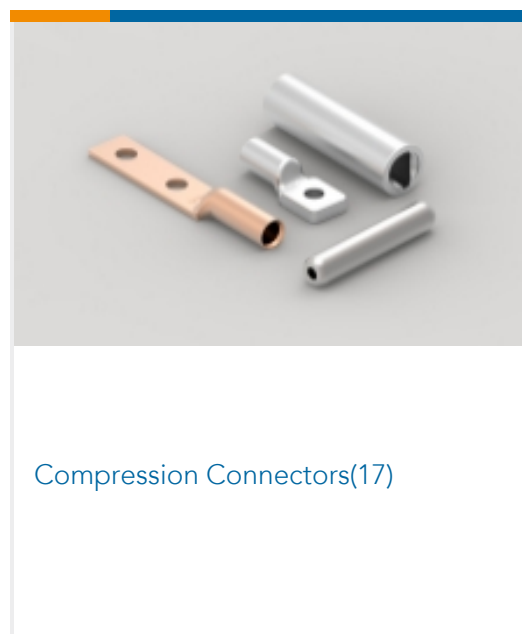

Customers Also Bought

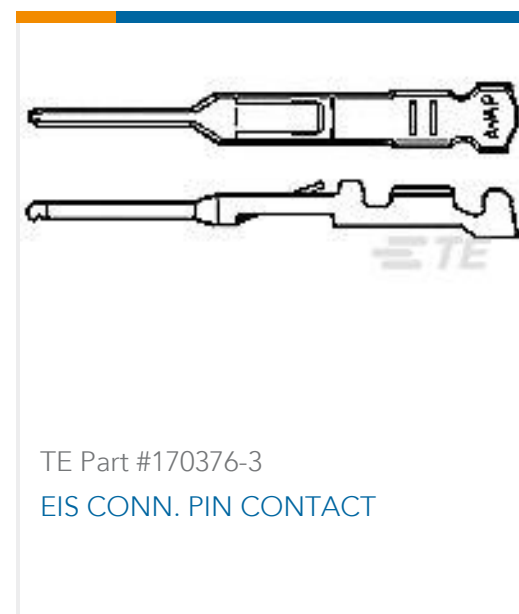

Documents

Product Drawings

[PIDG R 22-16 COMM 22-18 MIL 4](#)

English

CAD Files

[3D PDF](#)

3D

Customer View Model

[ENG_CVM_CVM_330648_G.2d_dxf.zip](#)

English

Customer View Model

[ENG_CVM_CVM_330648_G.3d_igs.zip](#)

English

Customer View Model

[ENG_CVM_CVM_330648_G.3d_stp.zip](#)

English

Customer View Model

[ENG_CVM_330648_F.3d_igs.zip](#)

English

Customer View Model

[ENG_CVM_330648_F.3d_stp.zip](#)

English

Customer View Model

[ENG_CVM_330648_F.2d_dxf.zip](#)

English

[3D PDF](#)

English



By downloading the CAD file I accept and agree to the [Terms and Conditions](#) of use.

Datasheets & Catalog Pages

PIDG TERMINALS & SPLICES Quick Reference Guide

English

Standard Terminals & Splices

English

Product Specifications

Application Specification

English

Product Environmental Compliance

MD_330648_0215201804_dmtec

English

MD_330648_0215201804_dmtec

English

Agency Approvals

UL Report

English