



SOLISTRAND

TE Internal #: 330368

Splices, 16 – 14 AWG Wire Size, 1.25 – 2 mm² Wire Size, Sight Hole, .085 in [2.16 mm] Barrel Inside Diameter, 2050 – 5180 CMA Wire Size, Copper

[View on TE.com >](#)

Terminals & Splices > Splices

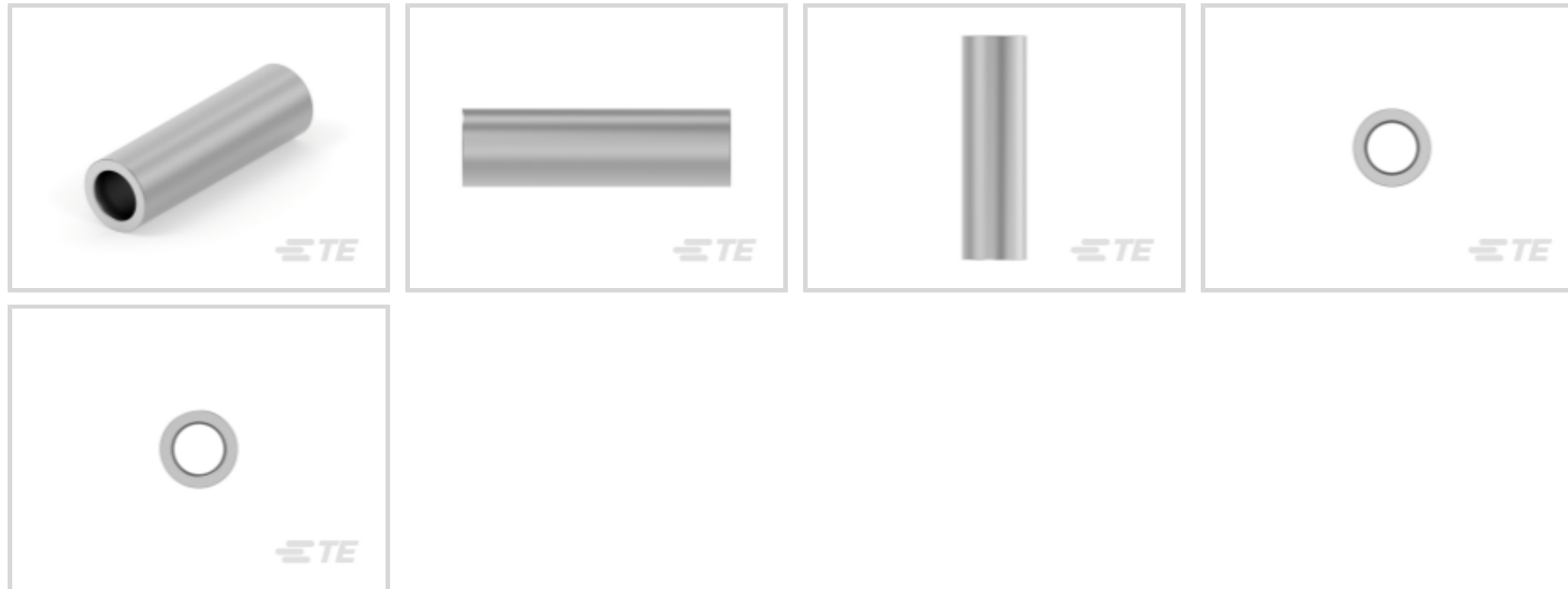

Wire Size: 1.25 – 2 mm²

Sealable: No

Splice Features: **Sight Hole**

Barrel Inside Diameter: 2.16 mm [.085 in]

Features

Product Type Features

Discrete Wire Type	Solid or Stranded
Splice Accessory Type	Splice
Sealable	No
Splice Type	Butt Splice
Serrated	Yes
Compatible With Discrete Wire Type	Solid, Stranded
Wire Insulation Support Retention Type	Non-Insulation Support

Configuration Features

Number of Serrations	16
Compatible With Wire & Cable Type	Discrete Wire

Body Features

Plating Thickness	2.54 μm[100 μin]
Plating Material	Tin
Splice Features	Sight Hole
Primary Product Material	Copper



Contact Features

Contact Plating Material	Tin
Contact Plating Thickness	2.54 µm[100 µin]
Barrel Type	Closed

Mechanical Attachment

Wire Insulation Support	Without
-------------------------	---------

Dimensions

Inside Diameter (Recovered)	2.16 mm[.085 in]
Outside Diameter	4.19 mm[.165 in]
Wire Size	2050 – 5180 CMA
Barrel Inside Diameter	2.16 mm[.085 in]
Terminal Material Thickness	.84 mm[.033 in]
Overall Product Length	14.4 mm[.567 in]

Usage Conditions

High Temperature Rating	170 °C[338 °F]
Insulation Requirement	Uninsulated
Operating Temperature Range	170 °C[338 °F]

Operation/Application

Heavy Duty	No
Compatible With Wire Base Material	Copper

Industry Standards

Government Qualified Splice	No
-----------------------------	----

Packaging Features

Packaging Quantity	1000
Packaging Method	Loose Piece

Other

Military Category	No
-------------------	----

Product Compliance

[For compliance documentation, visit the product page on TE.com>](#)

EU RoHS Directive 2011/65/EU	Compliant
------------------------------	-----------











EU ELV Directive 2000/53/EC	Compliant
China RoHS 2 Directive MIIT Order No 32, 2016	No Restricted Materials Above Threshold
EU REACH Regulation (EC) No. 1907/2006	Current ECHA Candidate List: JAN 2022 (223) Candidate List Declared Against: JAN 2022 (223) Does not contain REACH SVHC
Halogen Content	Low Halogen - Br, Cl, F, I < 900 ppm per homogenous material. Also BFR/CFR/PVC Free
Solder Process Capability	Not applicable for solder process capability

Product Compliance Disclaimer

This information is provided based on reasonable inquiry of our suppliers and represents our current actual knowledge based on the information they provided. This information is subject to change. The part numbers that TE has identified as EU RoHS compliant have a maximum concentration of 0.1% by weight in homogenous materials for lead, hexavalent chromium, mercury, PBB, PBDE, DBP, BBP, DEHP, DIBP, and 0.01% for cadmium, or qualify for an exemption to these limits as defined in the Annexes of Directive 2011/65/EU (RoHS2). Finished electrical and electronic equipment products will be CE marked as required by Directive 2011/65/EU. Components may not be CE marked. Additionally, the part numbers that TE has identified as EU ELV compliant have a maximum concentration of 0.1% by weight in homogenous materials for lead, hexavalent chromium, and mercury, and 0.01% for cadmium, or qualify for an exemption to these limits as defined in the Annexes of Directive 2000/53/EC (ELV). Regarding the REACH Regulation, the information TE provides on SVHC in articles for this part number is based on the latest European Chemicals Agency (ECHA) 'Guidance on requirements for substances in articles' posted at this URL: <https://echa.europa.eu/guidance-documents/guidance-on-reach>

Compatible Parts

 <p>TE Part # 58545-1 SOLISTRAND 10-22 DIE ASSY</p>	 <p>TE Part # 49935 DAHT SOLIS 22-10 ASSY</p>	 <p>TE Part # 58546-1 PC 22-10 SOLISSPICE SPL I SHT</p>	 <p>TE Part # 525693 DAHT SOLIS 22-10 ASSY</p>
 <p>TE Part # 58545-3 SDE DIE ASSY. 22-10 SOLISTRAND</p>	 <p>TE Part # 47813 DIES SOLIS 16-14 DIE SET</p>	 <p>TE Part # 539662-2 MATR SOLISTR 0,3-6,</p>	 <p>TE Part # 169400 CERTI-LOK</p>

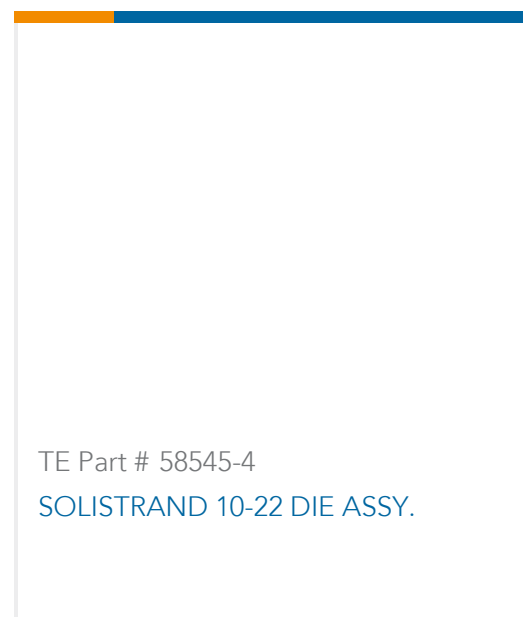

Customers Also Bought

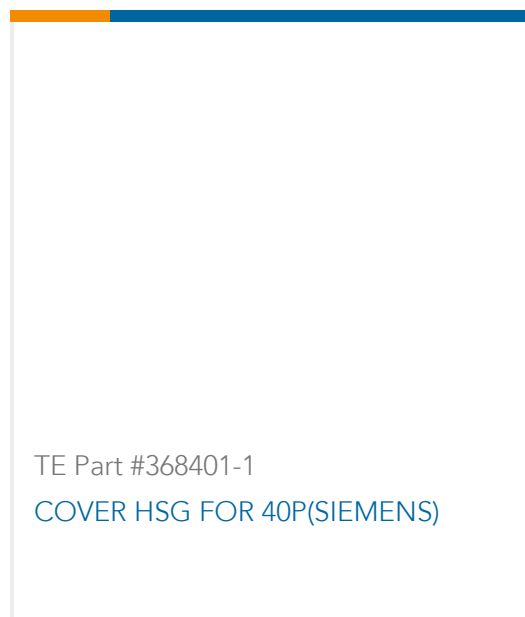
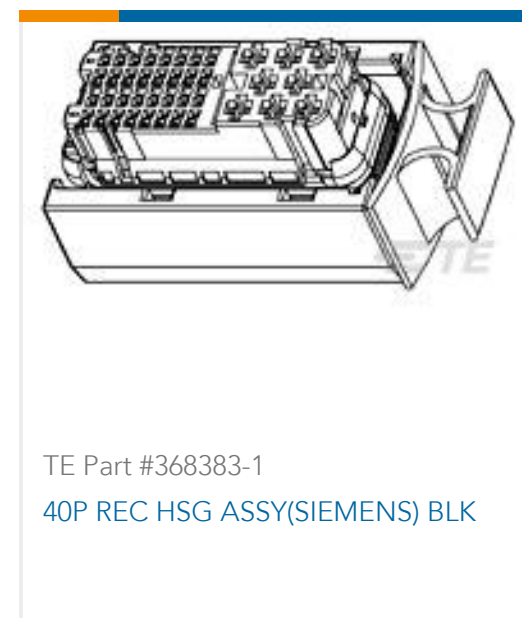
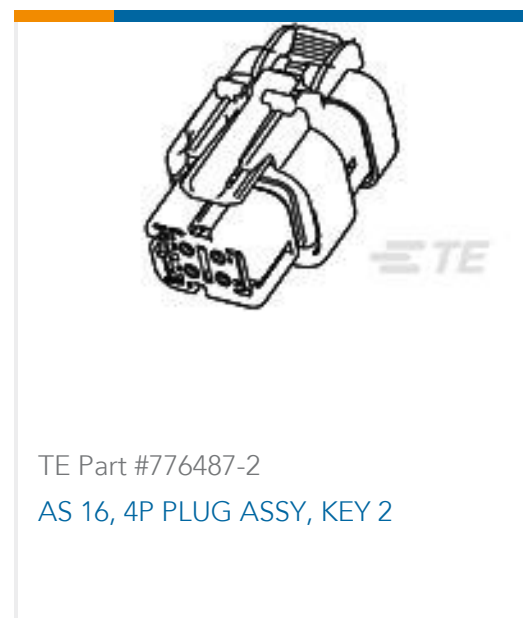
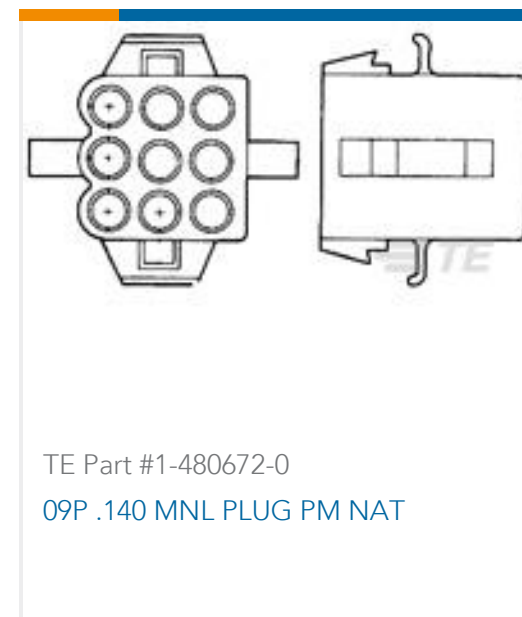
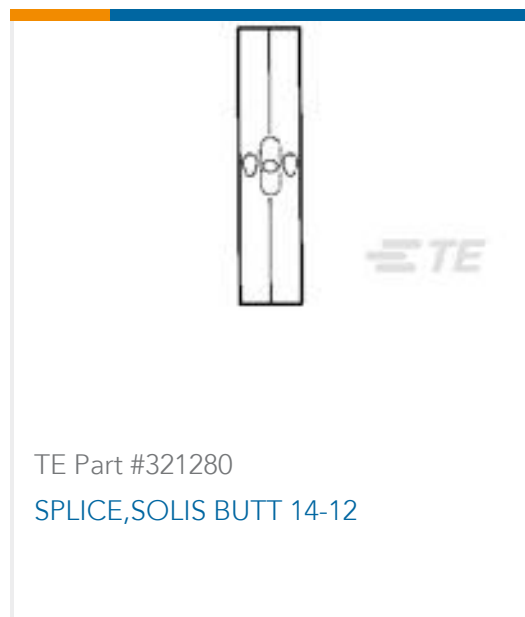

Documents

Product Drawings
 SPLICE,SOLIS BUTT 16-14
 English

CAD Files
 3D PDF
 3D

Customer View Model
 ENG_CVM_CVM_330368_H.2d_dxf.zip



English

Customer View Model

[ENG_CVM_CVM_330368_H.3d_igs.zip](#)

English

Customer View Model

[ENG_CVM_CVM_330368_H.3d_stp.zip](#)

English

By downloading the CAD file I accept and agree to the [Terms and Conditions](#) of use.

Datasheets & Catalog Pages

[SOLISTRAND - QRG](#)

English

Product Environmental Compliance

[TE Material Declaration](#)

English

Agency Approvals

[UL Report](#)

English