

Data sheet | Item number: 2210-1301

3-conductor through terminal block; with push-button; 10 mm²; with test port; side and center marking; for DIN-rail 35 x 15 and 35 x 7.5; Push-in CAGE CLAMP®

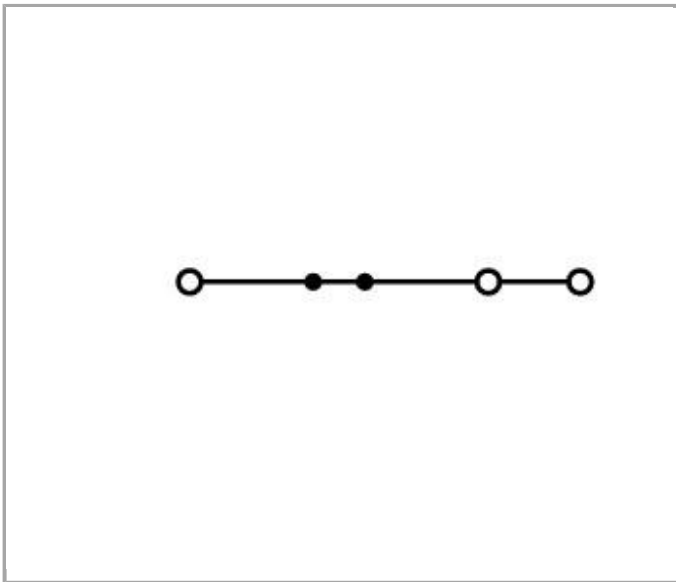

www.wago.com/2210-1301

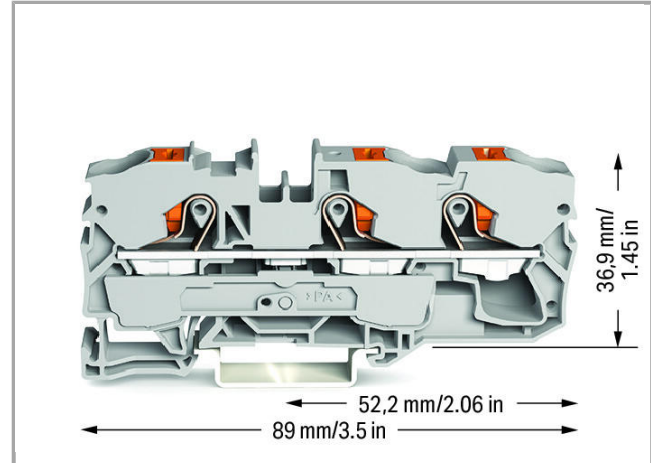
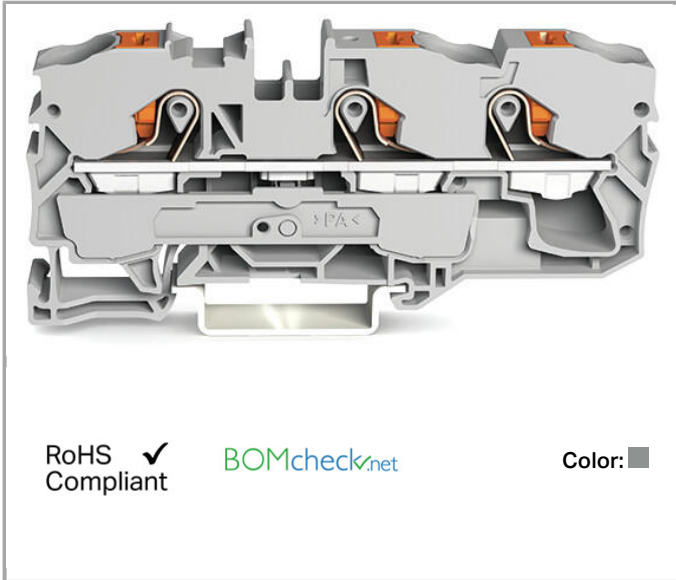

Data

Electrical data

Ratings per IEC/EN 60664-1

Rated voltage (III / 3)	800 V
Rated impulse voltage (III / 3)	8 kV
Rated current	57 A
Rated current (2)	76 A



Connection data

Connection technology	Push-in CAGE CLAMP®
Actuation type	Push-in Push-button
Connectable conductor materials	Copper
Nominal cross section	10 mm ²
Solid conductor	0.5 ... 16 mm ² / 20 ... 6 AWG
Solid conductor, push-in termination	2.5 ... 16 mm ² / 14 ... 6 AWG
Fine-stranded conductor	0.5 ... 16 mm ² / 20 ... 6 AWG
Strip length	17 ... 19 mm / 0.67 ... 0.75 inch
Total number of connection points	3
Total number of potentials	1
Number of levels	1
Type of wiring	Front-entry wiring

Geometrical Data

Width	10 mm / 0.394 inch
Height from upper-edge of DIN-35 rail	36.9 mm / 1.453 inch
Depth	89 mm / 3.504 inch

Mechanical data

Design	horizontal
Type of mounting	DIN-35 rail
Marking level	Center/side marking

Material Data



Color	gray
Insulating material	Polyamide 66 (PA 66)
Fire load	0 MJ
Weight	25.537 g

Commercial data



Country of origin	DE
GTIN	4055143736114
Customs Tariff No.	85369010000

Approvals / Certificates



Ex-Approvals

Logo	Approval	Additional Approval Text	Certificate name
	ATEX Physikalisch Technische Bundesanstalt	IEC 60079-0	PTB 18 ATEX 1008
	ATEX UL International Demko A/S	UL 60079	E185892
	IECEX Physikalisch Technische Bundesanstalt	IEC 60079	IECEX PTB 18.0015U (Ex eb IIC Gb and Ex eb I Mb)

Country specific Approvals

















Logo	Approval	Additional Approval Text	Certificate name
	CSA DEKRA Certification B.V.	C22.2	70175033
	KEMA/KEUR DEKRA Certification B.V.	EN 60947	71- 102880















UL-Approvals

















Logo	Approval	Additional Approval Text	Certificate name
	UL Underwriters Laboratories Inc.	UL 1059	4788362280
	UL Underwriters Laboratories Inc.	UL 1059	4788362280

Compatible products

General accessories

	Item no.: 2010-100 Finger guard; touchproof cover protects unused conductor entries	www.wago.com/2010-100
check		
	Item no.: 2009-174 Test plug adapter; for 4 mm Ø test plugs; for testing TOPJOB®S rail-mounted terminal blocks	www.wago.com/2009-174
	Item no.: 2009-182 Testing tap; for max. 2.5 mm ² ; tool-free connection for individual test wires 0.08 - 2.5 mm	www.wago.com/2009-182
	Item no.: 2010-511 Modular TOPJOB®S connector; modular; for jumper contact slot; 1-pole	www.wago.com/2010-511
	Item no.: 2010-549 Spacer module; modular; e.g., for bridging commoned terminal blocks	www.wago.com/2010-549
tools		
	Item no.: 210-721 Operating tool with partially insulated shaft; Type 3, blade (5.5 x 0.8) mm	www.wago.com/210-721
End plate		
	Item no.: 2010-1391 End and intermediate plate; 1 mm thick	www.wago.com/2010-1391
	Item no.: 2010-1392 End and intermediate plate; 1 mm thick	www.wago.com/2010-1392
Carrier rail		
	Item no.: 210-113 Steel carrier rail; 35 x 7.5 mm; 1 mm thick; 2 m long; unslotted; according to EN 60715	www.wago.com/210-113
	Item no.: 210-114 Steel carrier rail; 35 x 15 mm; 1.5 mm thick; 2 m long; unslotted; similar to EN 60715	www.wago.com/210-114
	Item no.: 210-118 Steel carrier rail; 35 x 15 mm; 2.3 mm thick; 2 m long; unslotted; according to EN 60715	www.wago.com/210-118
	Item no.: 210-196 Aluminum carrier rail; 35 x 8.2 mm; 1.6 mm thick; 2 m long; unslotted; similar to EN 60715	www.wago.com/210-196
	Item no.: 210-197 Steel carrier rail; 35 x 15 mm; 1.5 mm thick; 2 m long; slotted; similar to EN 60715	www.wago.com/210-197
	Item no.: 210-198 Copper carrier rail; 35 x 15 mm; 2.3 mm thick; 2 m long; unslotted; according to EN 60715	www.wago.com/210-198
Marking accessories		
	Item no.: 2009-110 Marking strips; on reel; not stretchable; plain; snap-on type	www.wago.com/2009-110
	Item no.: 2009-115 WMB-Inline; for Smart Printer; on reel; stretchable 5 - 5.2 mm; plain; snap-on type	www.wago.com/2009-115

	Item no.: 2009-115/000-002 WMB-Inline; for Smart Printer; on reel; stretchable 5 - 5.2 mm; plain; snap-on type	www.wago.com/2009-115/000-002
	Item no.: 2009-115/000-006 WMB-Inline; for smartPRINTER; on reel; stretchable 5 - 5.2 mm; plain; snap-on type	www.wago.com/2009-115/000-006
	Item no.: 2009-115/000-007 WMB-Inline; for Smart Printer; on reel; stretchable 5 - 5.2 mm; plain; snap-on type	www.wago.com/2009-115/000-007
	Item no.: 2009-115/000-012 WMB-Inline; for smartPRINTER; on reel; stretchable 5 - 5.2 mm; plain; snap-on type	www.wago.com/2009-115/000-012
	Item no.: 2009-115/000-017 WMB-Inline; for Smart Printer; on reel; stretchable 5 - 5.2 mm; plain; snap-on type	www.wago.com/2009-115/000-017
	Item no.: 2009-115/000-023 WMB-Inline; for Smart Printer; on reel; stretchable 5 - 5.2 mm; plain; snap-on type	www.wago.com/2009-115/000-023
	Item no.: 2009-115/000-024 WMB-Inline; for smartPRINTER; on reel; stretchable 5 - 5.2 mm; plain; snap-on type	www.wago.com/2009-115/000-024
	Item no.: 2009-145 Mini-WSB Inline; for Smart Printer; on reel; stretchable 5 - 5.2 mm; plain; snap-on type	www.wago.com/2009-145
	Item no.: 2009-145/000-002 Mini-WSB Inline; for Smart Printer; on reel; stretchable 5 - 5.2 mm; plain; snap-on type	www.wago.com/2009-145/000-002
	Item no.: 2009-145/000-005 Mini-WSB Inline; for Smart Printer; on reel; stretchable 5 - 5.2 mm; plain; snap-on type	www.wago.com/2009-145/000-005
	Item no.: 2009-145/000-006 Mini-WSB Inline; for Smart Printer; on reel; stretchable 5 - 5.2 mm; plain; snap-on type	www.wago.com/2009-145/000-006
	Item no.: 2009-145/000-007 Mini-WSB Inline; for Smart Printer; on reel; stretchable 5 - 5.2 mm; plain; snap-on type	www.wago.com/2009-145/000-007
	Item no.: 2009-145/000-012 Mini-WSB Inline; for Smart Printer; on reel; stretchable 5 - 5.2 mm; plain; snap-on type	www.wago.com/2009-145/000-012
	Item no.: 2009-145/000-023 Mini-WSB Inline; for smartPRINTER; on reel; stretchable 5 - 5.2 mm; plain; snap-on type	www.wago.com/2009-145/000-023
	Item no.: 2009-145/000-024 Mini-WSB Inline; for Smart Printer; on reel; stretchable 5 - 5.2 mm; plain; snap-on type	www.wago.com/2009-145/000-024

	Item no.: 2009-191 Group marker carrier	www.wago.com/2009-191
	Item no.: 2009-192 Group marker carrier	www.wago.com/2009-192
	Item no.: 2009-193 Group marker carrier	www.wago.com/2009-193
	Item no.: 2009-198 Adaptor	www.wago.com/2009-198
	Item no.: 248-501 Miniature WSB Quick marking system; plain; Marker width 5 mm; 10 strips with 10 markers per card	www.wago.com/248-501
	Item no.: 248-501/000-002 Mini-WSB marking card; as card; not stretchable; plain; snap-on type	www.wago.com/248-501/000-002
	Item no.: 248-501/000-005 Mini-WSB marking card; as card; not stretchable; plain; snap-on type	www.wago.com/248-501/000-005
	Item no.: 248-501/000-006 Mini-WSB marking card; as card; not stretchable; plain; snap-on type	www.wago.com/248-501/000-006
	Item no.: 248-501/000-007 Mini-WSB marking card; as card; not stretchable; plain; snap-on type	www.wago.com/248-501/000-007
	Item no.: 248-501/000-012 Mini-WSB marking card; as card; not stretchable; plain; snap-on type	www.wago.com/248-501/000-012
	Item no.: 248-501/000-017 Mini-WSB marking card; as card; not stretchable; plain; snap-on type	www.wago.com/248-501/000-017
	Item no.: 248-501/000-023 Mini-WSB marking card; as card; not stretchable; plain; snap-on type	www.wago.com/248-501/000-023
	Item no.: 248-501/000-024 Mini-WSB marking card; as card; not stretchable; plain; snap-on type	www.wago.com/248-501/000-024
	Item no.: 793-501 WMB marking card; as card; not stretchable; plain; snap-on type	www.wago.com/793-501
	Item no.: 793-501/000-002 WMB marking card; as card; not stretchable; plain; snap-on type	www.wago.com/793-501/000-002
	Item no.: 793-501/000-005 WMB marking card; as card; not stretchable; plain; snap-on type	www.wago.com/793-501/000-005



Item no.: 793-501/000-006
WMB marking card; as card; not stretchable; plain; snap-on type

www.wago.com/793-501/000-006



Item no.: 793-501/000-007
WMB marking card; as card; not stretchable; plain; snap-on type

www.wago.com/793-501/000-007



Item no.: 793-501/000-012
WMB marking card; as card; not stretchable; plain; snap-on type

www.wago.com/793-501/000-012



Item no.: 793-501/000-017
WMB marking card; as card; not stretchable; plain; snap-on type

www.wago.com/793-501/000-017



Item no.: 793-501/000-023
WMB marking card; as card; not stretchable; plain; snap-on type

www.wago.com/793-501/000-023



Item no.: 793-501/000-024
WMB marking card; as card; not stretchable; plain; snap-on type

www.wago.com/793-501/000-024



Item no.: 793-5501
WMB marking card; as card; for terminal block width 5 - 17.5 mm; stretchable 5 - 5.2 mm; plain; snap-on type

www.wago.com/793-5501



Item no.: 793-5501/000-002
WMB marking card; as card; for terminal block width 5 - 17.5 mm; stretchable 5 - 5.2 mm; plain; snap-on type

www.wago.com/793-5501/000-002



Item no.: 793-5501/000-005
WMB marking card; as card; stretchable 5 - 5.2 mm; plain; snap-on type

www.wago.com/793-5501/000-005



Item no.: 793-5501/000-006
WMB marking card; as card; stretchable 5 - 5.2 mm; plain; snap-on type

www.wago.com/793-5501/000-006



Item no.: 793-5501/000-007
WMB marking card; as card; stretchable 5 - 5.2 mm; plain; snap-on type

www.wago.com/793-5501/000-007



Item no.: 793-5501/000-012
WMB marking card; as card; stretchable 5 - 5.2 mm; plain; snap-on type

www.wago.com/793-5501/000-012



Item no.: 793-5501/000-017
WMB marking card; as card; stretchable 5 - 5.2 mm; plain; snap-on type

www.wago.com/793-5501/000-017



Item no.: 793-5501/000-023
WMB marking card; as card; stretchable 5 - 5.2 mm; plain; snap-on type

















www.wago.com/793-5501/000-023

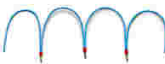

Item no.: 793-5501/000-024
WMB marking card; as card; stretchable 5 - 5.2 mm; plain; snap-on type

www.wago.com/793-5501/000-024

Jumper

	Item no.: 2010-402 Push-in type jumper bar; insulated; 2-way; Nominal current 57 A	www.wago.com/2010-402
	Item no.: 2010-403 Push-in type jumper bar; insulated; 3-way; Nominal current 57 A	www.wago.com/2010-403
	Item no.: 2010-404 Push-in type jumper bar; insulated; 4-way; Nominal current 57 A	www.wago.com/2010-404
	Item no.: 2010-405 Push-in type jumper bar; insulated; 5-way; Nominal current 57 A	www.wago.com/2010-405
	Item no.: 2010-405/011-000 Star point jumper; insulated; 3-way (1-3-5); IN = IN terminal block	www.wago.com/2010-405/011-000
	Item no.: 2010-433 Push-in type jumper bar; insulated; from 1 to 3; Nominal current 57 A	www.wago.com/2010-433
	Item no.: 2010-434 Push-in type jumper bar; insulated; from 1 to 4; Nominal current 57 A	www.wago.com/2010-434
	Item no.: 2010-435 Push-in type jumper bar; insulated; from 1 to 5; Nominal current 57 A	www.wago.com/2010-435
	Item no.: 2016-499 Step-down jumper; insulated; from 16/10 mm ² to 10/6/4/2.5 mm ² ; Nominal current 57 A	www.wago.com/2016-499
	Item no.: 210-103 Wire commoning chain; insulated; 50 connections	www.wago.com/210-103
	Item no.: 210-123 Wire commoning chain; insulated; 50 connections	www.wago.com/210-123
	Item no.: 285-430 Step-down jumper; insulated; from 285-13x to 2010 and 2016 Series TOPJOB®S terminal blocks; Nominal current 90 A	www.wago.com/285-430
ferrule		
	Item no.: 216-284 Ferrule; Sleeve for 1.5 mm ² / AWG 16; insulated; electro-tin plated; electrolytic copper; gastight crimped; acc. to DIN 46228, Part 4/09.90	www.wago.com/216-284
	Item no.: 216-286 Ferrule; Sleeve for 2.5 mm ² / AWG 14; insulated; electro-tin plated; electrolytic copper; gastight crimped; acc. to DIN 46228, Part 4/09.90	www.wago.com/216-286
	Item no.: 216-287 Ferrule; Sleeve for 4 mm ² / AWG 12; insulated; electro-tin plated; electrolytic copper; gastight crimped; acc. to DIN 46228, Part 4/09.90	www.wago.com/216-287
	Item no.: 216-288 Ferrule; Sleeve for 6 mm ² / AWG 10; insulated; electro-tin plated; electrolytic copper; gastight crimped; acc. to DIN 46228, Part 4/09.90	www.wago.com/216-288
	Item no.: 216-289 Ferrule; Sleeve for 10 mm ² / AWG 8; insulated; electro-tin plated; electrolytic copper; gastight crimped; acc. to DIN 46228, Part 4/09.90	www.wago.com/216-289



Downloads

Documentation

Bid Text

2210-1301	docx 15.2 kB	Download
-----------	-----------------	----------

CAD/CAE - Smart Data

CAD data

3D Download 2210-1301	Download
-----------------------	----------

Subject to changes.