

**Data sheet | Item number: 2210-1204**

2-conductor through terminal block; with push-button; 10 mm<sup>2</sup>; with test port; suitable for Ex i applications; side and center marking; for DIN-rail 35 x 15 and 35 x 7.5; Push-in CAGE CLAMP®

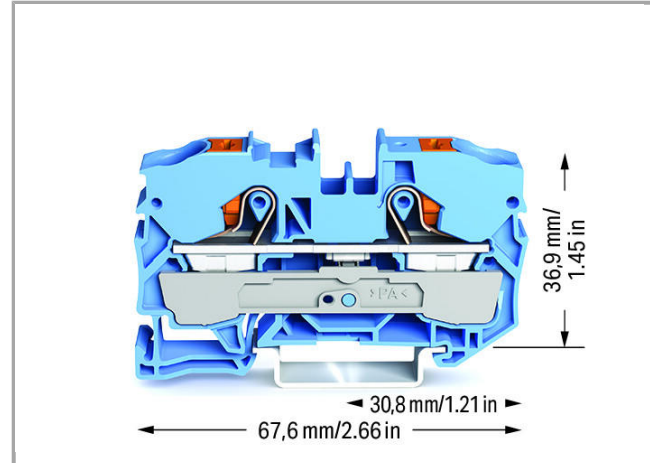

[www.wago.com/2210-1204](http://www.wago.com/2210-1204)

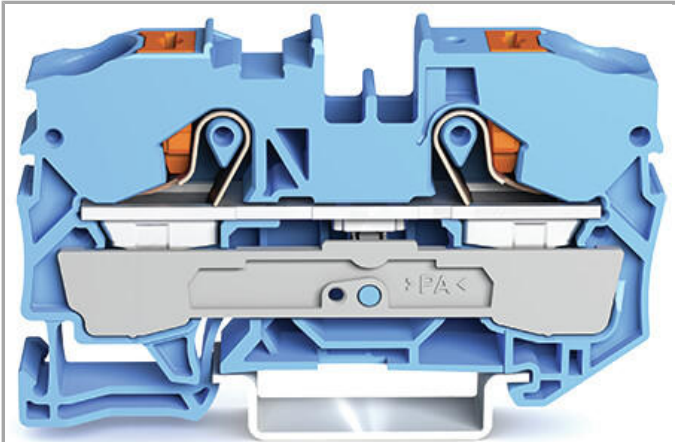

RoHS  Compliant

BOMcheck.net

Color: ■

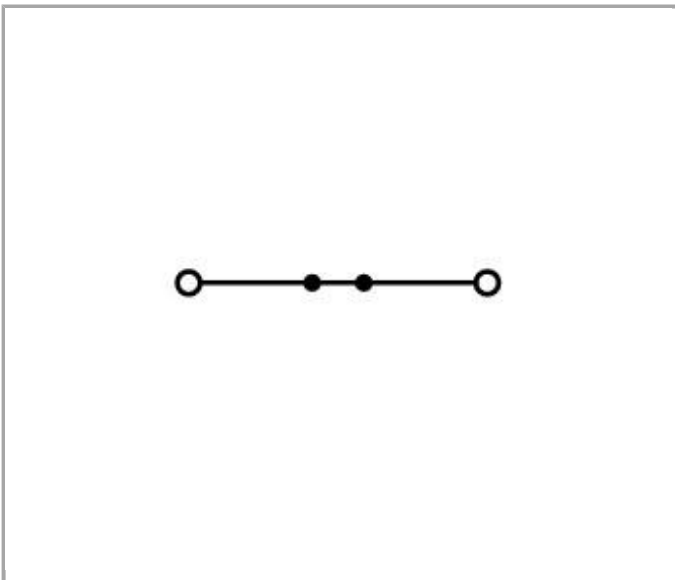

**Data**

**Electrical data**

**Ratings per IEC/EN 60664-1**

Rated voltage (III / 3)

800 V



Rated impulse voltage (III / 3)	8 kV
Rated current	57 A
Rated current (2)	76 A

### Connection data

Connection technology	Push-in CAGE CLAMP®
Actuation type	Push-button Push-in
Connectable conductor materials	Copper
Nominal cross section	10 mm <sup>2</sup>
Solid conductor	0.5 ... 16 mm <sup>2</sup> / 20 ... 6 AWG
Solid conductor, push-in termination	2.5 ... 16 mm <sup>2</sup> / 14 ... 6 AWG
Fine-stranded conductor	0.5 ... 16 mm <sup>2</sup> / 20 ... 6 AWG
Strip length	17 ... 19 mm / 0.67 ... 0.75 inch
Total number of connection points	2
Total number of potentials	1
Number of levels	1
Type of wiring	Front-entry wiring

### Geometrical Data

Width	10 mm / 0.394 inch
Height from upper-edge of DIN-35 rail	36.9 mm / 1.453 inch
Depth	67.6 mm / 2.661 inch

### Mechanical data

Design	horizontal
Type of mounting	DIN-35 rail
Marking level	Center/side marking

### Material Data



Color	blue
Insulating material	Polyamide 66 (PA 66)
Fire load	0 MJ
Weight	18.975 g

### Commercial data



Country of origin	DE
GTIN	4055143736077
Customs Tariff No.	85369010000

## Approvals / Certificates



### Ex-Approvals

Logo	Approval	Additional Approval Text	Certificate name
	ATEX Physikalisch Technische Bundesanstalt	IEC 60079-0	PTB 18 ATEX 1008
	ATEX UL International Demko A/S	UL 60079	E185892
	IECEX Physikalisch Technische Bundesanstalt	IEC 60079	IECEX PTB 18.0015U (Ex eb IIC Gb and Ex eb I Mb)

### Country specific Approvals















Logo	Approval	Additional Approval Text	Certificate name
	CSA DEKRA Certification B.V.	C22.2	70175033
	KEMA/KEUR DEKRA Certification B.V.	EN 60947	71- 102880

















### UL-Approvals

Logo	Approval	Additional Approval Text	Certificate name
	UL Underwriters Laboratories Inc.	UL 1059	4788362280
	UL Underwriters Laboratories Inc.	UL 1059	4788362280

## Compatible products

## Marking accessories

	<b>Item no.: 2009-110</b> Marking strips; on reel; not stretchable; plain; snap-on type	<a href="http://www.wago.com/2009-110">www.wago.com/2009-110</a>
	<b>Item no.: 2009-115</b> WMB-Inline; for Smart Printer; on reel; stretchable 5 - 5.2 mm; plain; snap-on type	<a href="http://www.wago.com/2009-115">www.wago.com/2009-115</a>
	<b>Item no.: 2009-115/000-002</b> WMB-Inline; for Smart Printer; on reel; stretchable 5 - 5.2 mm; plain; snap-on type	<a href="http://www.wago.com/2009-115/000-002">www.wago.com/2009-115/000-002</a>
	<b>Item no.: 2009-115/000-006</b> WMB-Inline; for smartPRINTER; on reel; stretchable 5 - 5.2 mm; plain; snap-on type	<a href="http://www.wago.com/2009-115/000-006">www.wago.com/2009-115/000-006</a>
	<b>Item no.: 2009-115/000-007</b> WMB-Inline; for Smart Printer; on reel; stretchable 5 - 5.2 mm; plain; snap-on type	<a href="http://www.wago.com/2009-115/000-007">www.wago.com/2009-115/000-007</a>
	<b>Item no.: 2009-115/000-012</b> WMB-Inline; for smartPRINTER; on reel; stretchable 5 - 5.2 mm; plain; snap-on type	<a href="http://www.wago.com/2009-115/000-012">www.wago.com/2009-115/000-012</a>
	<b>Item no.: 2009-115/000-017</b> WMB-Inline; for Smart Printer; on reel; stretchable 5 - 5.2 mm; plain; snap-on type	<a href="http://www.wago.com/2009-115/000-017">www.wago.com/2009-115/000-017</a>
	<b>Item no.: 2009-115/000-023</b> WMB-Inline; for Smart Printer; on reel; stretchable 5 - 5.2 mm; plain; snap-on type	<a href="http://www.wago.com/2009-115/000-023">www.wago.com/2009-115/000-023</a>
	<b>Item no.: 2009-115/000-024</b> WMB-Inline; for smartPRINTER; on reel; stretchable 5 - 5.2 mm; plain; snap-on type	<a href="http://www.wago.com/2009-115/000-024">www.wago.com/2009-115/000-024</a>
	<b>Item no.: 2009-145</b> Mini-WSB Inline; for Smart Printer; on reel; stretchable 5 - 5.2 mm; plain; snap-on type	<a href="http://www.wago.com/2009-145">www.wago.com/2009-145</a>
	<b>Item no.: 2009-145/000-002</b> Mini-WSB Inline; for Smart Printer; on reel; stretchable 5 - 5.2 mm; plain; snap-on type	<a href="http://www.wago.com/2009-145/000-002">www.wago.com/2009-145/000-002</a>
	<b>Item no.: 2009-145/000-005</b> Mini-WSB Inline; for Smart Printer; on reel; stretchable 5 - 5.2 mm; plain; snap-on type	<a href="http://www.wago.com/2009-145/000-005">www.wago.com/2009-145/000-005</a>
	<b>Item no.: 2009-145/000-006</b> Mini-WSB Inline; for Smart Printer; on reel; stretchable 5 - 5.2 mm; plain; snap-on type	<a href="http://www.wago.com/2009-145/000-006">www.wago.com/2009-145/000-006</a>
	<b>Item no.: 2009-145/000-007</b> Mini-WSB Inline; for Smart Printer; on reel; stretchable 5 - 5.2 mm; plain; snap-on type	<a href="http://www.wago.com/2009-145/000-007">www.wago.com/2009-145/000-007</a>

	<p><b>Item no.: 2009-145/000-012</b>                  Mini-WSB Inline; for Smart Printer; on reel; stretchable 5 - 5.2 mm; plain; snap-on type</p>	<a href="http://www.wago.com/2009-145/000-012">www.wago.com/2009-145/000-012</a>
	<p><b>Item no.: 2009-145/000-023</b>                  Mini-WSB Inline; for smartPRINTER; on reel; stretchable 5 - 5.2 mm; plain; snap-on type</p>	<a href="http://www.wago.com/2009-145/000-023">www.wago.com/2009-145/000-023</a>
	<p><b>Item no.: 2009-145/000-024</b>                  Mini-WSB Inline; for Smart Printer; on reel; stretchable 5 - 5.2 mm; plain; snap-on type</p>	<a href="http://www.wago.com/2009-145/000-024">www.wago.com/2009-145/000-024</a>
	<p><b>Item no.: 2009-191</b>                  Group marker carrier</p>	<a href="http://www.wago.com/2009-191">www.wago.com/2009-191</a>
	<p><b>Item no.: 2009-192</b>                  Group marker carrier</p>	<a href="http://www.wago.com/2009-192">www.wago.com/2009-192</a>
	<p><b>Item no.: 2009-193</b>                  Group marker carrier</p>	<a href="http://www.wago.com/2009-193">www.wago.com/2009-193</a>
	<p><b>Item no.: 2009-198</b>                  Adaptor</p>	<a href="http://www.wago.com/2009-198">www.wago.com/2009-198</a>
	<p><b>Item no.: 248-501</b>                  Miniature WSB Quick marking system; plain; Marker width 5 mm; 10 strips with 10 markers per card</p>	<a href="http://www.wago.com/248-501">www.wago.com/248-501</a>
	<p><b>Item no.: 248-501/000-002</b>                  Mini-WSB marking card; as card; not stretchable; plain; snap-on type</p>	<a href="http://www.wago.com/248-501/000-002">www.wago.com/248-501/000-002</a>
	<p><b>Item no.: 248-501/000-005</b>                  Mini-WSB marking card; as card; not stretchable; plain; snap-on type</p>	<a href="http://www.wago.com/248-501/000-005">www.wago.com/248-501/000-005</a>
	<p><b>Item no.: 248-501/000-006</b>                  Mini-WSB marking card; as card; not stretchable; plain; snap-on type</p>	<a href="http://www.wago.com/248-501/000-006">www.wago.com/248-501/000-006</a>
	<p><b>Item no.: 248-501/000-007</b>                  Mini-WSB marking card; as card; not stretchable; plain; snap-on type</p>	<a href="http://www.wago.com/248-501/000-007">www.wago.com/248-501/000-007</a>
	<p><b>Item no.: 248-501/000-012</b>                  Mini-WSB marking card; as card; not stretchable; plain; snap-on type</p>	<a href="http://www.wago.com/248-501/000-012">www.wago.com/248-501/000-012</a>
	<p><b>Item no.: 248-501/000-017</b>                  Mini-WSB marking card; as card; not stretchable; plain; snap-on type</p>	<a href="http://www.wago.com/248-501/000-017">www.wago.com/248-501/000-017</a>
	<p><b>Item no.: 248-501/000-023</b>                  Mini-WSB marking card; as card; not stretchable; plain; snap-on type</p>	<a href="http://www.wago.com/248-501/000-023">www.wago.com/248-501/000-023</a>
	<p><b>Item no.: 248-501/000-024</b>                  Mini-WSB marking card; as card; not stretchable; plain; snap-on type</p>	<a href="http://www.wago.com/248-501/000-024">www.wago.com/248-501/000-024</a>



**Item no.: 793-501**  
WMB marking card; as card; not stretchable; plain; snap-on type

[www.wago.com/793-501](http://www.wago.com/793-501)



**Item no.: 793-501/000-002**  
WMB marking card; as card; not stretchable; plain; snap-on type

[www.wago.com/793-501/000-002](http://www.wago.com/793-501/000-002)



**Item no.: 793-501/000-005**  
WMB marking card; as card; not stretchable; plain; snap-on type

[www.wago.com/793-501/000-005](http://www.wago.com/793-501/000-005)



**Item no.: 793-501/000-006**  
WMB marking card; as card; not stretchable; plain; snap-on type

[www.wago.com/793-501/000-006](http://www.wago.com/793-501/000-006)



**Item no.: 793-501/000-007**  
WMB marking card; as card; not stretchable; plain; snap-on type

[www.wago.com/793-501/000-007](http://www.wago.com/793-501/000-007)



**Item no.: 793-501/000-012**  
WMB marking card; as card; not stretchable; plain; snap-on type

[www.wago.com/793-501/000-012](http://www.wago.com/793-501/000-012)



**Item no.: 793-501/000-017**  
WMB marking card; as card; not stretchable; plain; snap-on type

[www.wago.com/793-501/000-017](http://www.wago.com/793-501/000-017)



**Item no.: 793-501/000-023**  
WMB marking card; as card; not stretchable; plain; snap-on type

[www.wago.com/793-501/000-023](http://www.wago.com/793-501/000-023)



**Item no.: 793-501/000-024**  
WMB marking card; as card; not stretchable; plain; snap-on type

[www.wago.com/793-501/000-024](http://www.wago.com/793-501/000-024)



**Item no.: 793-5501**  
WMB marking card; as card; for terminal block width 5 - 17.5 mm; stretchable 5 - 5.2 mm; plain; snap-on type

[www.wago.com/793-5501](http://www.wago.com/793-5501)



**Item no.: 793-5501/000-002**  
WMB marking card; as card; for terminal block width 5 - 17.5 mm; stretchable 5 - 5.2 mm; plain; snap-on type

[www.wago.com/793-5501/000-002](http://www.wago.com/793-5501/000-002)



**Item no.: 793-5501/000-005**  
WMB marking card; as card; stretchable 5 - 5.2 mm; plain; snap-on type

[www.wago.com/793-5501/000-005](http://www.wago.com/793-5501/000-005)



**Item no.: 793-5501/000-006**  
WMB marking card; as card; stretchable 5 - 5.2 mm; plain; snap-on type

[www.wago.com/793-5501/000-006](http://www.wago.com/793-5501/000-006)



**Item no.: 793-5501/000-007**  
WMB marking card; as card; stretchable 5 - 5.2 mm; plain; snap-on type

[www.wago.com/793-5501/000-007](http://www.wago.com/793-5501/000-007)



**Item no.: 793-5501/000-012**  
WMB marking card; as card; stretchable 5 - 5.2 mm; plain; snap-on type

[www.wago.com/793-5501/000-012](http://www.wago.com/793-5501/000-012)



**Item no.: 793-5501/000-017**  
WMB marking card; as card; stretchable 5 - 5.2 mm; plain; snap-on type

[www.wago.com/793-5501/000-017](http://www.wago.com/793-5501/000-017)



**Item no.: 793-5501/000-023**  
WMB marking card; as card; stretchable 5 - 5.2 mm; plain; snap-on type

[www.wago.com/793-5501/000-023](http://www.wago.com/793-5501/000-023)



**Item no.: 793-5501/000-024**  
WMB marking card; as card; stretchable 5 - 5.2 mm; plain; snap-on type

[www.wago.com/793-5501/000-024](http://www.wago.com/793-5501/000-024)

#### End plate



**Item no.: 2010-1291**  
End and intermediate plate; 1 mm thick

[www.wago.com/2010-1291](http://www.wago.com/2010-1291)



**Item no.: 2010-1292**  
End and intermediate plate; 1 mm thick

[www.wago.com/2010-1292](http://www.wago.com/2010-1292)

#### Jumper



**Item no.: 2010-402**  
Push-in type jumper bar; insulated; 2-way; Nominal current 57 A

[www.wago.com/2010-402](http://www.wago.com/2010-402)



**Item no.: 2010-403**  
Push-in type jumper bar; insulated; 3-way; Nominal current 57 A

[www.wago.com/2010-403](http://www.wago.com/2010-403)



**Item no.: 2010-404**  
Push-in type jumper bar; insulated; 4-way; Nominal current 57 A

[www.wago.com/2010-404](http://www.wago.com/2010-404)



**Item no.: 2010-405**  
Push-in type jumper bar; insulated; 5-way; Nominal current 57 A

[www.wago.com/2010-405](http://www.wago.com/2010-405)



**Item no.: 2010-405/011-000**  
Star point jumper; insulated; 3-way (1-3-5); IN = IN terminal block

[www.wago.com/2010-405/011-000](http://www.wago.com/2010-405/011-000)



**Item no.: 2010-433**  
Push-in type jumper bar; insulated; from 1 to 3; Nominal current 57 A

[www.wago.com/2010-433](http://www.wago.com/2010-433)



**Item no.: 2010-434**  
Push-in type jumper bar; insulated; from 1 to 4; Nominal current 57 A

[www.wago.com/2010-434](http://www.wago.com/2010-434)



**Item no.: 2010-435**  
Push-in type jumper bar; insulated; from 1 to 5; Nominal current 57 A

[www.wago.com/2010-435](http://www.wago.com/2010-435)



**Item no.: 2016-499**  
Step-down jumper; insulated; from 16/10 mm<sup>2</sup> to 10/6/4/2.5 mm<sup>2</sup>; Nominal current 57 A

[www.wago.com/2016-499](http://www.wago.com/2016-499)



**Item no.: 210-103**  
Wire commoning chain; insulated; 50 connections

[www.wago.com/210-103](http://www.wago.com/210-103)



**Item no.: 210-123**  
Wire commoning chain; insulated; 50 connections

















[www.wago.com/210-123](http://www.wago.com/210-123)



**Item no.: 285-430**  
Step-down jumper; insulated; from 285-13x to 2010 and 2016 Series TOPJOB®S terminal blocks; Nominal current 90 A

[www.wago.com/285-430](http://www.wago.com/285-430)

#### check

	<b>Item no.: 2009-174</b> Test plug adapter; for 4 mm Ø test plugs; for testing TOPJOB®S rail-mounted terminal blocks	<a href="http://www.wago.com/2009-174">www.wago.com/2009-174</a>
	<b>Item no.: 2009-182</b> Testing tap; for max. 2.5 mm <sup>2</sup> ; tool-free connection for individual test wires 0.08 - 2.5 mm	<a href="http://www.wago.com/2009-182">www.wago.com/2009-182</a>
	<b>Item no.: 2010-511</b> Modular TOPJOB®S connector; modular; for jumper contact slot; 1-pole	<a href="http://www.wago.com/2010-511">www.wago.com/2010-511</a>
	<b>Item no.: 2010-549</b> Spacer module; modular; e.g., for bridging commoned terminal blocks	<a href="http://www.wago.com/2010-549">www.wago.com/2010-549</a>
<b>ferrule</b>		
	<b>Item no.: 216-284</b> Ferrule; Sleeve for 1.5 mm <sup>2</sup> / AWG 16; insulated; electro-tin plated; electrolytic copper; gastight crimped; acc. to DIN 46228, Part 4/09.90	<a href="http://www.wago.com/216-284">www.wago.com/216-284</a>
	<b>Item no.: 216-286</b> Ferrule; Sleeve for 2.5 mm <sup>2</sup> / AWG 14; insulated; electro-tin plated; electrolytic copper; gastight crimped; acc. to DIN 46228, Part 4/09.90	<a href="http://www.wago.com/216-286">www.wago.com/216-286</a>
	<b>Item no.: 216-287</b> Ferrule; Sleeve for 4 mm <sup>2</sup> / AWG 12; insulated; electro-tin plated; electrolytic copper; gastight crimped; acc. to DIN 46228, Part 4/09.90	<a href="http://www.wago.com/216-287">www.wago.com/216-287</a>
	<b>Item no.: 216-288</b> Ferrule; Sleeve for 6 mm <sup>2</sup> / AWG 10; insulated; electro-tin plated; electrolytic copper; gastight crimped; acc. to DIN 46228, Part 4/09.90	<a href="http://www.wago.com/216-288">www.wago.com/216-288</a>
	<b>Item no.: 216-289</b> Ferrule; Sleeve for 10 mm <sup>2</sup> / AWG 8; insulated; electro-tin plated; electrolytic copper; gastight crimped; acc. to DIN 46228, Part 4/09.90	<a href="http://www.wago.com/216-289">www.wago.com/216-289</a>
<b>Carrier rail</b>		
	<b>Item no.: 210-113</b> Steel carrier rail; 35 x 7.5 mm; 1 mm thick; 2 m long; unslotted; according to EN 60715	<a href="http://www.wago.com/210-113">www.wago.com/210-113</a>
	<b>Item no.: 210-114</b> Steel carrier rail; 35 x 15 mm; 1.5 mm thick; 2 m long; unslotted; similar to EN 60715	<a href="http://www.wago.com/210-114">www.wago.com/210-114</a>
	<b>Item no.: 210-118</b> Steel carrier rail; 35 x 15 mm; 2.3 mm thick; 2 m long; unslotted; according to EN 60715	<a href="http://www.wago.com/210-118">www.wago.com/210-118</a>
	<b>Item no.: 210-196</b> Aluminum carrier rail; 35 x 8.2 mm; 1.6 mm thick; 2 m long; unslotted; similar to EN 60715	<a href="http://www.wago.com/210-196">www.wago.com/210-196</a>
	<b>Item no.: 210-197</b> Steel carrier rail; 35 x 15 mm; 1.5 mm thick; 2 m long; slotted; similar to EN 60715	<a href="http://www.wago.com/210-197">www.wago.com/210-197</a>
	<b>Item no.: 210-198</b> Copper carrier rail; 35 x 15 mm; 2.3 mm thick; 2 m long; unslotted; according to EN 60715	<a href="http://www.wago.com/210-198">www.wago.com/210-198</a>
<b>tools</b>		
	<b>Item no.: 210-721</b> Operating tool with partially insulated shaft; Type 3, blade (5.5 x 0.8) mm	<a href="http://www.wago.com/210-721">www.wago.com/210-721</a>
<b>General accessories</b>		
	<b>Item no.: 2010-100</b> Finger guard; touchproof cover protects unused conductor entries	<a href="http://www.wago.com/2010-100">www.wago.com/2010-100</a>





Downloads

Documentation

Bid Text

---

2210-1204	docx 15.3 kB	Download
-----------	-----------------	----------

---

CAD/CAE - Smart Data

CAD data

---

3D Download 2210-1204	URL	Download
-----------------------	-----	----------

---

Subject to changes.