

Data sheet | Item number: 2116-5201

2-conductor through terminal block; with lever and push-button; 16 mm<sup>2</sup>; with test port; side and center marking; for DIN-rail 35 x 15 and 35 x 7.5; Push-in CAGE CLAMP®

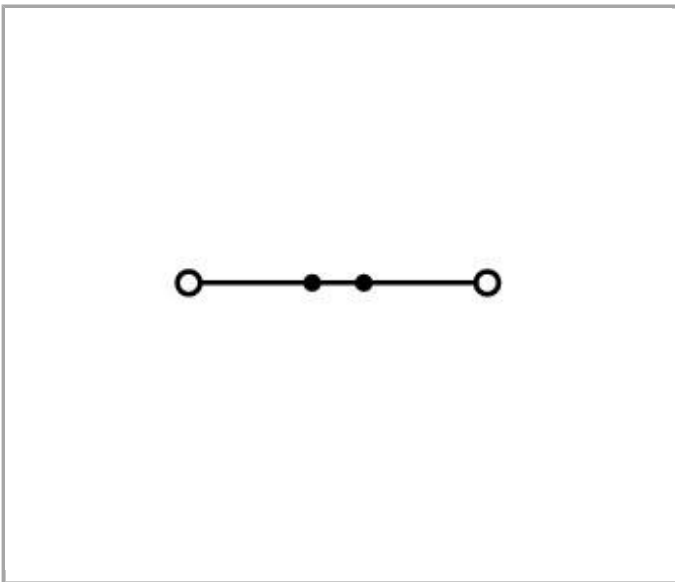

[www.wago.com/2116-5201](http://www.wago.com/2116-5201)

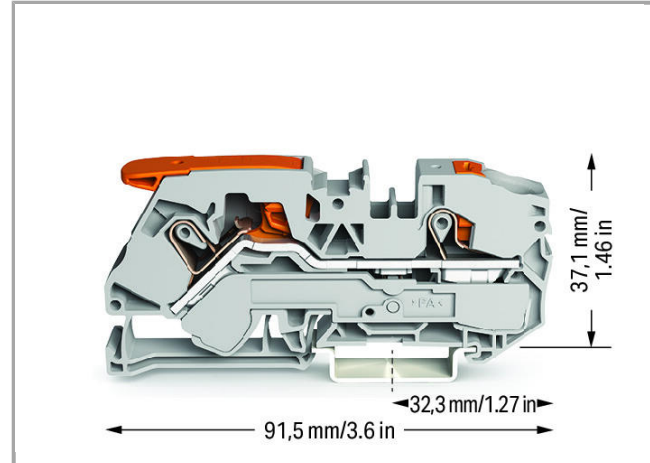
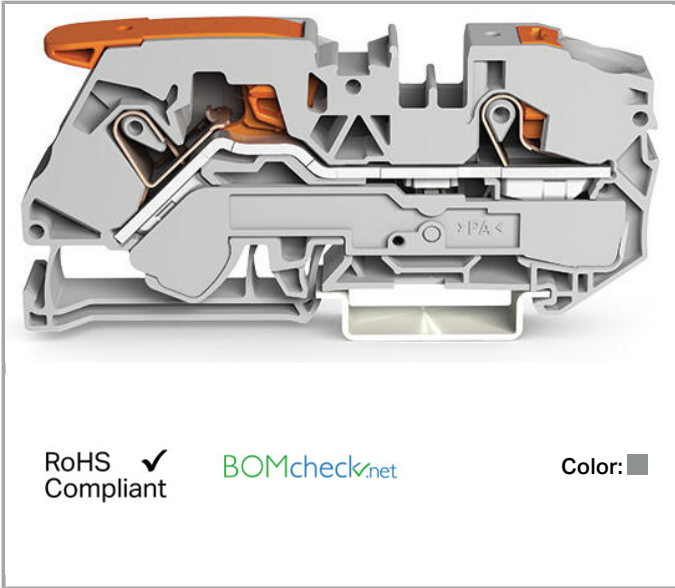

Data

Electrical data

Ratings per IEC/EN 60664-1

Rated voltage (III / 3)	800 V
Rated impulse voltage (III / 3)	8 kV
Rated current	76 A



Rated current (2)	90 A
-------------------	------

### Connection data

Connection technology	Push-in CAGE CLAMP®
Actuation type	Push-in Lever Push-button
Actuation type 2	Push-in Push-button Operating tool
Connectable conductor materials	Copper
Nominal cross section	16 mm <sup>2</sup>
Solid conductor	0.5 ... 16 mm <sup>2</sup> / 20 ... 6 AWG
Solid conductor, push-in termination	2.5 ... 16 mm <sup>2</sup> / 14 ... 6 AWG
Fine-stranded conductor	0.5 ... 25 mm <sup>2</sup> / 20 ... 4 AWG
Strip length	18 ... 20 mm / 0.71 ... 0.79 inch
Total number of connection points	2
Total number of potentials	1
Number of levels	1
Type of wiring	Front-entry wiring

### Geometrical Data

Width	12 mm / 0.472 inch
Height from upper-edge of DIN-35 rail	37.1 mm / 1.461 inch
Depth	91.5 mm / 3.602 inch

### Mechanical data

Design	horizontal
Type of mounting	DIN-35 rail
Marking level	Center/side marking

### Material Data

Color	gray
Insulating material	Polyamide 66 (PA 66)
Fire load	0 MJ
Weight	32.35 g

### Commercial data



Country of origin	DE
GTIN	4055143754507

Customs Tariff No.



85369010000

## Approvals / Certificates



### Ex-Approvals

Logo	Approval	Additional Approval Text	Certificate name
	<b>AEx</b> UL International Germany GmbH c/o Physikalisch Technische Bundesanstalt	UL 60079	E185892
	<b>ATEX</b> Physikalisch Technische Bundesanstalt	EN 60079-0	PTB ATEX 1012 U
	<b>IECEX</b> Physikalisch Technische Bundesanstalt	IEC 60079-0	IECEX PTB 18.0019U

### Country specific Approvals

Logo	Approval	Additional Approval Text	Certificate name
	<b>CCA</b> DEKRA Certification B.V.	EN 60947	NTR NL 7675
	<b>CSA</b> DEKRA Certification B.V.	C22.2	70175104
	<b>KEMA/KEUR</b> DEKRA Certification B.V.	EN 60947	71-103140

### UL-Approvals

Logo	Approval	Additional Approval Text	Certificate name
	<b>cURus</b> Underwriters Laboratories Inc.	UL 1059	E45172
	<b>cURus</b> Underwriters Laboratories Inc.	UL 1059	E45172



Downloads

Documentation

Bid Text

---

2116-5201	docx 15.2 kB	Download
-----------	-----------------	----------

---

CAD/CAE - Smart Data

CAD data

---

3D Download 2116-5201	URL	Download
-----------------------	-----	----------

---

Subject to changes.