

Data sheet | Item number: 2104-1201

2-conductor through terminal block; with lever and Push-in CAGE CLAMP®; 4 mm²; with test port; side and center marking; for DIN-rail 35 x 15 and 35 x 7.5; Push-in CAGE CLAMP®; 4,00 mm²; gray

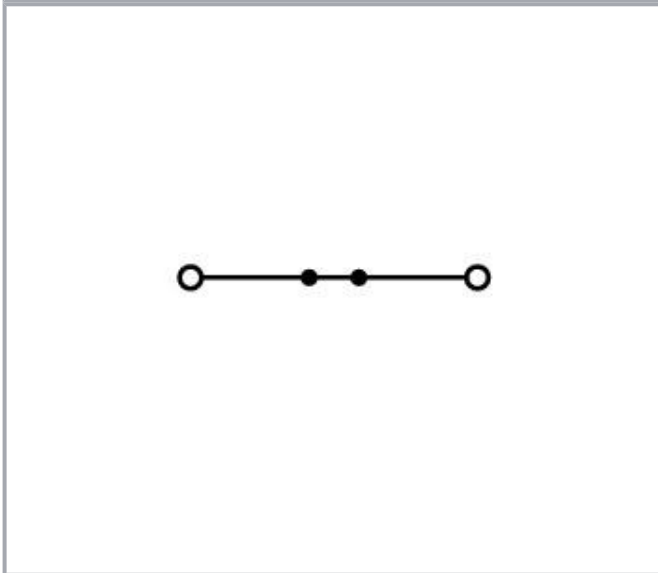

www.wago.com/2104-1201

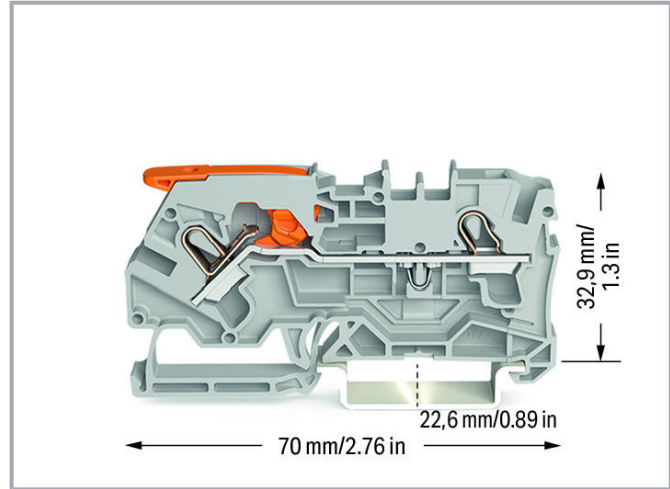
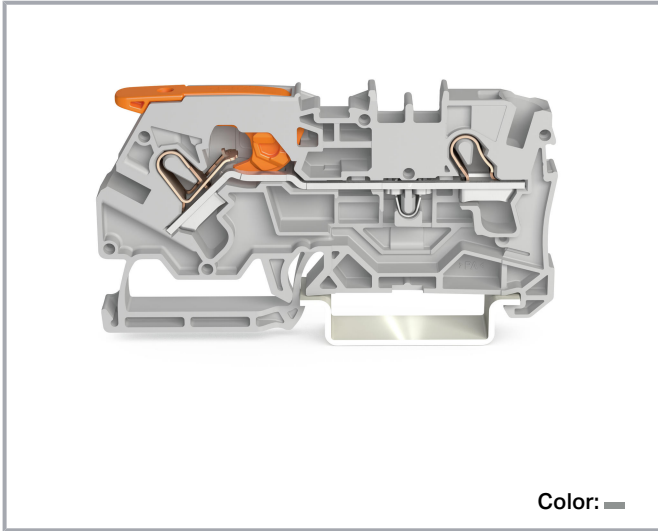

Data

Electrical data

Ratings per IEC/EN

Ratings per

IEC/EN 60947-7-1

Subject to changes. Please also observe the further product documentation!

WAGO Kontakttechnik GmbH & Co. KG
Hansastr. 27
32423 Minden
Phone: +49571 887-0 | Fax: +49571 887-169
Email: info.de@wago.com | Web: www.wago.com

Do you have any questions about our products?
We are always happy to take your call at +49 (571) 887-44222.



Nominal voltage (III/3)	800 V
Rated surge voltage (III/3)	8 kV
Rated current	32 A
Rated current 2	40 A
Legend (ratings)	(III / 3) $\hat{=}$ Overvoltage category III / Pollution degree 3

Ratings per UL

Approvals per	UL 1059
Rated voltage UL (Use Group B)	600 V
Rated current UL (Use Group B)	30 A
Rated voltage UL (Use Group C)	600 V
Rated current UL (Use Group C)	30 A

Ratings per CSA

Approvals per	C22.2 No 158
Rated voltage CSA (Use Group B)	600 V
Rated current CSA (Use Group B)	30 A
Rated voltage CSA (Use Group C)	600 V
Rated current CSA (Use Group C)	30 A

Ex information

Ratings per	ATEX: PTB 20 ATEX 1006 U / IECEx: PTB 20.0012U (Ex eb IIC Gb)
Rated voltage EN (Ex e II)	550 V
Rated current (Ex e II)	30 A

Connection data

Connection technology	Push-in CAGE CLAMP [®]
Actuation type	Push-in Lever
Connectable conductor materials	Copper Copper
Nominal cross-section	4 mm ²
Solid conductor	0.5 ... 6 mm ² / 20 ... 10 AWG
Solid conductor; push-in termination	1.5 ... 6 mm ² / 14 ... 10 AWG
Fine-stranded conductor	0.5 ... 6 mm ² / 20 ... 10 AWG
Fine-stranded conductor; with insulated ferrule	0.5 ... 4 mm ² / 20 ... 12 AWG
Fine-stranded conductor; with ferrule; push-in termination	1.5 ... 4 mm ² / 18 ... 12 AWG

Subject to changes. Please also observe the further product documentation!

Note (conductor cross-section)	Depending on the conductor characteristic, a conductor with a smaller cross-section can also be inserted via push-in termination.
Strip length	11 ... 13 mm / 0.43 ... 0.51 inch
Total number of connection points	2
Total number of potentials	1
Number of levels	1
Number of jumper slots	2

Physical data

Width	6.2 mm / 0.244 inch
Height	70 mm / 2.756 inch
Depth from upper edge of DIN-rail	32.9 mm / 1.295 inch

Mechanical data

Design	horizontal type
Mounting type	DIN-35 rail
Marking level	Center/side marking

Material data

Color	gray
Insulation material	Polyamide (PA66)
Weight	10.3 g

Commercial data

Packaging type	BOX
Country of origin	PL
GTIN	4055143992282
Customs tariff number	85369010000



Approvals / Certificates

Ex-Approvals

Logo	Approval	Additional Approval Text	Certificate name
 Ex e IIC Gb Ex e I Mb	CCCEX CQST/CNEX	CNCA-C23-01	2020312313000276

Subject to changes. Please also observe the further product documentation!

Country specific Approvals



Logo	Approval	Additional Approval Text	Certificate name
	CCA DEKRA Certification B.V.	EN 60947	NTR NL 7835
	CSA DEKRA Certification B.V.	C22.2	80058036
	KEMA/KEUR DEKRA Certification B.V.	EN 60947	71- 114078

UL-Approvals

Logo	Approval	Additional Approval Text	Certificate name
	UL Underwriters Laboratories Inc.	UL 1059	E45172



Required accessories

End plate







	Item no.: 2104-1291 End and intermediate plate; 1 mm thick; gray	www.wago.com/2104-1291
	Item no.: 2104-1292 End and intermediate plate; 1 mm thick; orange	www.wago.com/2104-1292

Compatible products

















ferrule

	Item no.: 216-262 Ferrule; Sleeve for 0.75 mm ² / 18 AWG; insulated; electro-tin plated; electrolytic copper; gastight crimped; acc. to DIN 46228, Part 4/09.90; gray	www.wago.com/216-262
	Item no.: 216-263 Ferrule; Sleeve for 1 mm ² / AWG 18; insulated; electro-tin plated; electrolytic copper; gastight crimped; acc. to DIN 46228, Part 4/09.90; red	www.wago.com/216-263
	Item no.: 216-264	

Subject to changes. Please also observe the further product documentation!

	Ferrule; Sleeve for 1.5 mm ² / AWG 16; insulated; electro-tin plated; electrolytic copper; gastight crimped; acc. to DIN 46228, Part 4/09.90; black	www.wago.com/216-264
	Item no.: 216-266	
	Ferrule; Sleeve for 2.5 mm ² / AWG 14; insulated; electro-tin plated; electrolytic copper; gastight crimped; acc. to DIN 46228, Part 4/09.90; blue	www.wago.com/216-266
	Item no.: 216-267	
	Ferrule; Sleeve for 4 mm ² / AWG 12; insulated; electro-tin plated; electrolytic copper; gastight crimped; acc. to DIN 46228, Part 4/09.90; gray	www.wago.com/216-267
Carrier rail		
	Item no.: 210-112	
	Steel carrier rail; 35 x 7.5 mm; 1 mm thick; 2 m long; slotted; according to EN 60715; "Hole width 25 mm; silver-colored	www.wago.com/210-112
	Item no.: 210-113	
	Steel carrier rail; 35 x 7.5 mm; 1 mm thick; 2 m long; unslotted; according to EN 60715; silver-colored	www.wago.com/210-113
	Item no.: 210-114	
	Steel carrier rail; 35 x 15 mm; 1.5 mm thick; 2 m long; unslotted; similar to EN 60715; silver-colored	www.wago.com/210-114
	Item no.: 210-115	
	Steel carrier rail; 35 x 7.5 mm; 1 mm thick; 2 m long; slotted; according to EN 60715; "Hole width 18 mm; silver-colored	www.wago.com/210-115
	Item no.: 210-118	
	Steel carrier rail; 35 x 15 mm; 2.3 mm thick; 2 m long; unslotted; according to EN 60715; silver-colored	www.wago.com/210-118
	Item no.: 210-196	
	Aluminum carrier rail; 35 x 8.2 mm; 1.6 mm thick; 2 m long; unslotted; similar to EN 60715; silver-colored	www.wago.com/210-196
	Item no.: 210-197	
	Steel carrier rail; 35 x 15 mm; 1.5 mm thick; 2 m long; slotted; similar to EN 60715; silver-colored	www.wago.com/210-197
	Item no.: 210-198	
	Copper carrier rail; 35 x 15 mm; 2.3 mm thick; 2 m long; unslotted; according to EN 60715; copper-colored	www.wago.com/210-198
	Item no.: 210-504	
	Steel carrier rail; 35 x 7.5 mm; 1 mm thick; 2 m long; slotted; galvanized; according to EN 60715; silver-colored	www.wago.com/210-504
	Item no.: 210-505	
	Steel carrier rail; 35 x 7.5 mm; 1 mm thick; 2 m long; unslotted; galvanized; according to EN 60715; silver-colored	www.wago.com/210-505
	Item no.: 210-506	
	Steel carrier rail; 35 x 15 mm; 1.5 mm thick; 2 m long; unslotted; galvanized; similar to EN 60715; silver-colored	www.wago.com/210-506
	Item no.: 210-508	
	Steel carrier rail; 35 x 15 mm; 1.5 mm thick; 2 m long; slotted; galvanized; similar to EN 60715; silver-colored	www.wago.com/210-508
Jumper		
	Item no.: 2004-402 Jumper; 2-way; insulated; light gray	www.wago.com/2004-402

Subject to changes. Please also observe the further product documentation!

	Item no.: 2004-403 Jumper; 3-way; insulated; light gray	www.wago.com/2004-403
	Item no.: 2004-404 Jumper; 4-way; insulated; light gray	www.wago.com/2004-404
	Item no.: 2004-405 Jumper; 5-way; insulated; light gray	www.wago.com/2004-405
	Item no.: 2004-405/011-000 Star point jumper; 3-way; insulated; light gray	www.wago.com/2004-405/011-000
	Item no.: 2004-406 Jumper; 6-way; insulated; light gray	www.wago.com/2004-406
	Item no.: 2004-406/020-000 Delta jumper; insulated; light gray	www.wago.com/2004-406/020-000
	Item no.: 2004-407 Jumper; 7-way; insulated; light gray	www.wago.com/2004-407
	Item no.: 2004-408 Jumper; 8-way; insulated; light gray	www.wago.com/2004-408
	Item no.: 2004-409 Jumper; 9-way; insulated; light gray	www.wago.com/2004-409
	Item no.: 2004-410 Jumper; 10-way; insulated; light gray	www.wago.com/2004-410
	Item no.: 2004-433 Jumper; from 1 to 3; insulated; light gray	www.wago.com/2004-433
	Item no.: 2004-434 Jumper; from 1 to 4; insulated; light gray	www.wago.com/2004-434
	Item no.: 2004-435 Jumper; from 1 to 5; insulated; light gray	www.wago.com/2004-435
	Item no.: 2004-436 Jumper; from 1 to 6; insulated; light gray	www.wago.com/2004-436
	Item no.: 2004-437 Jumper; from 1 to 7; insulated; light gray	www.wago.com/2004-437
	Item no.: 2004-438 Jumper; from 1 to 8; insulated; light gray	www.wago.com/2004-438
	Item no.: 2004-439 Jumper; from 1 to 9; insulated; light gray	www.wago.com/2004-439

Subject to changes. Please also observe the further product documentation!



Item no.: 2004-440
Jumper; from 1 to 10; insulated; light gray

www.wago.com/2004-440



Item no.: 210-103
Wire commoning chain; insulated; black

www.wago.com/210-103



Item no.: 210-123
Wire commoning chain; insulated; blue

www.wago.com/210-123

Insulation stop



Item no.: 2004-171
Insulation stop; 0.25 - 0.5 mm²; 5 pieces/strip; light gray

www.wago.com/2004-171



Item no.: 2004-172
Insulation stop; 0.75 - 1 mm²; 5 pieces/strip; dark gray

www.wago.com/2004-172

Marking accessories



Item no.: 2009-110
Marking strips; for Smart Printer; on reel; not stretchable; plain; snap-on type; white

www.wago.com/2009-110



Item no.: 2009-115
WMB-Inline; for Smart Printer; 1500 pieces on roll; stretchable 5 - 5.2 mm; plain; snap-on type; white

www.wago.com/2009-115



Item no.: 2009-115/000-002
WMB-Inline; for Smart Printer; 1500 pieces on roll; stretchable 5 - 5.2 mm; plain; snap-on type; yellow

www.wago.com/2009-115/000-002



Item no.: 2009-115/000-005
WMB-Inline; for Smart Printer; 1500 pieces on roll; stretchable 5 - 5.2 mm; plain; snap-on type; red

www.wago.com/2009-115/000-005



Item no.: 2009-115/000-006
WMB-Inline; for Smart Printer; 1500 pieces on roll; stretchable 5 - 5.2 mm; plain; snap-on type; blue

www.wago.com/2009-115/000-006



Item no.: 2009-115/000-007
WMB-Inline; for Smart Printer; 1500 pieces on roll; stretchable 5 - 5.2 mm; plain; snap-on type; gray

www.wago.com/2009-115/000-007



Item no.: 2009-115/000-012
WMB-Inline; for Smart Printer; 1500 pieces on roll; stretchable 5 - 5.2 mm; plain; snap-on type; orange

www.wago.com/2009-115/000-012



Item no.: 2009-115/000-017
WMB-Inline; for Smart Printer; 1500 pieces on roll; stretchable 5 - 5.2 mm; plain; snap-on type; light green

www.wago.com/2009-115/000-017



Item no.: 2009-115/000-023
WMB-Inline; for Smart Printer; 1500 pieces on roll; stretchable 5 - 5.2 mm; plain; snap-on type; green

www.wago.com/2009-115/000-023















Item no.: 2009-115/000-024
WMB-Inline; for Smart Printer; 1500 pieces on roll; stretchable 5 - 5.2 mm; plain; snap-on type; violet

www.wago.com/2009-115/000-024













Subject to changes. Please also observe the further product documentation!

	Item no.: 2009-145 Mini-WSB Inline; for Smart Printer; 1700 pieces on roll; stretchable 5 - 5.2 mm; plain; snap-on type; white	www.wago.com/2009-145
	Item no.: 2009-145/000-002 Mini-WSB Inline; for Smart Printer; 1700 pieces on roll; stretchable 5 - 5.2 mm; plain; snap-on type; yellow	www.wago.com/2009-145/000-002
	Item no.: 2009-145/000-005 Mini-WSB Inline; for Smart Printer; 1700 pieces on roll; stretchable 5 - 5.2 mm; plain; snap-on type; red	www.wago.com/2009-145/000-005
	Item no.: 2009-145/000-006 Mini-WSB Inline; for Smart Printer; 1700 pieces on roll; stretchable 5 - 5.2 mm; plain; snap-on type; blue	www.wago.com/2009-145/000-006
	Item no.: 2009-145/000-007 Mini-WSB Inline; for Smart Printer; 1700 pieces on roll; stretchable 5 - 5.2 mm; plain; snap-on type; gray	www.wago.com/2009-145/000-007
	Item no.: 2009-145/000-012 Mini-WSB Inline; for Smart Printer; 1700 pieces on roll; stretchable 5 - 5.2 mm; plain; snap-on type; orange	www.wago.com/2009-145/000-012
	Item no.: 2009-145/000-023 Mini-WSB Inline; for Smart Printer; 1700 pieces on roll; stretchable 5 - 5.2 mm; plain; snap-on type; green	www.wago.com/2009-145/000-023
	Item no.: 2009-145/000-024 Mini-WSB Inline; for Smart Printer; 1700 pieces on roll; stretchable 5 - 5.2 mm; plain; snap-on type; violet	www.wago.com/2009-145/000-024
	Item no.: 2009-191 Group marker carrier	www.wago.com/2009-191
	Item no.: 2009-192 Group marker carrier	www.wago.com/2009-192
	Item no.: 2009-193 Group marker carrier	www.wago.com/2009-193
	Item no.: 2009-198 Adaptor; gray	www.wago.com/2009-198
	Item no.: 248-501 Mini-WSB marking card; as card; not stretchable; plain; snap-on type; white	www.wago.com/248-501
	Item no.: 248-501/000-002 Mini-WSB marking card; as card; not stretchable; plain; snap-on type; yellow	www.wago.com/248-501/000-002
	Item no.: 248-501/000-005 Mini-WSB marking card; as card; not stretchable; plain; snap-on type; red	www.wago.com/248-501/000-005

Subject to changes. Please also observe the further product documentation!

	Item no.: 248-501/000-006 Mini-WSB marking card; as card; not stretchable; plain; snap-on type; blue	www.wago.com/248-501/000-006
	Item no.: 248-501/000-007 Mini-WSB marking card; as card; not stretchable; plain; snap-on type; gray	www.wago.com/248-501/000-007
	Item no.: 248-501/000-012 Mini-WSB marking card; as card; not stretchable; plain; snap-on type; orange	www.wago.com/248-501/000-012
	Item no.: 248-501/000-017 Mini-WSB marking card; as card; not stretchable; plain; snap-on type; light green	www.wago.com/248-501/000-017
	Item no.: 248-501/000-023 Mini-WSB marking card; as card; not stretchable; plain; snap-on type; green	www.wago.com/248-501/000-023
	Item no.: 248-501/000-024 Mini-WSB marking card; as card; not stretchable; plain; snap-on type; violet	www.wago.com/248-501/000-024
	Item no.: 793-501 WMB marking card; as card; not stretchable; plain; snap-on type; white	www.wago.com/793-501
	Item no.: 793-501/000-002 WMB marking card; as card; not stretchable; plain; snap-on type; yellow	www.wago.com/793-501/000-002
	Item no.: 793-501/000-005 WMB marking card; as card; not stretchable; plain; snap-on type; red	www.wago.com/793-501/000-005
	Item no.: 793-501/000-006 WMB marking card; as card; not stretchable; plain; snap-on type; blue	www.wago.com/793-501/000-006
	Item no.: 793-501/000-007 WMB marking card; as card; not stretchable; plain; snap-on type; gray	www.wago.com/793-501/000-007
	Item no.: 793-501/000-012 WMB marking card; as card; not stretchable; plain; snap-on type; orange	www.wago.com/793-501/000-012
	Item no.: 793-501/000-017 WMB marking card; as card; not stretchable; plain; snap-on type; light green	www.wago.com/793-501/000-017

Subject to changes. Please also observe the further product documentation!







	Item no.: 793-501/000-023 WMB marking card; as card; not stretchable; plain; snap-on type; green	www.wago.com/793-501/000-023
	Item no.: 793-501/000-024 WMB marking card; as card; not stretchable; plain; snap-on type; violet	www.wago.com/793-501/000-024
	Item no.: 793-5501 WMB marking card; as card; for terminal block width 5 - 17.5 mm; stretchable 5 - 5.2 mm; plain; snap-on type; white	www.wago.com/793-5501
	Item no.: 793-5501/000-002 WMB marking card; as card; for terminal block width 5 - 17.5 mm; stretchable 5 - 5.2 mm; plain; snap-on type; yellow	www.wago.com/793-5501/000-002
	Item no.: 793-5501/000-005 WMB marking card; as card; for terminal block width 5 - 17.5 mm; stretchable 5 - 5.2 mm; plain; snap-on type; red	www.wago.com/793-5501/000-005
	Item no.: 793-5501/000-006 WMB marking card; as card; for terminal block width 5 - 17.5 mm; stretchable 5 - 5.2 mm; plain; snap-on type; blue	www.wago.com/793-5501/000-006
	Item no.: 793-5501/000-007 WMB marking card; as card; for terminal block width 5 - 17.5 mm; stretchable 5 - 5.2 mm; plain; snap-on type; gray	www.wago.com/793-5501/000-007
	Item no.: 793-5501/000-012 WMB marking card; as card; for terminal block width 5 - 17.5 mm; stretchable 5 - 5.2 mm; plain; snap-on type; orange	www.wago.com/793-5501/000-012
	Item no.: 793-5501/000-014 WMB marking card; as card; for terminal block width 5 - 17.5 mm; stretchable 5 - 5.2 mm; plain; snap-on type; brown	www.wago.com/793-5501/000-014
	Item no.: 793-5501/000-017 WMB marking card; as card; for terminal block width 5 - 17.5 mm; stretchable 5 - 5.2 mm; plain; snap-on type; green	www.wago.com/793-5501/000-017
	Item no.: 793-5501/000-023 WMB marking card; as card; for terminal block width 5 - 17.5 mm; stretchable 5 - 5.2 mm; plain; snap-on type; light green	www.wago.com/793-5501/000-023
	Item no.: 793-5501/000-024 WMB marking card; as card; for terminal block width 5 - 17.5 mm; stretchable 5 - 5.2 mm; plain; snap-on type; violet	www.wago.com/793-5501/000-024

Protective Warning Marker

	Item no.: 2004-115 Protective warning marker; with high-voltage symbol, black; for 5 terminal blocks; yellow	www.wago.com/2004-115
---	--	--

check

Subject to changes. Please also observe the further product documentation!

	Item no.: 2004-511 Modular TOPJOB®S connector; modular; for jumper contact slot; 1-pole; 4,00 mm ² ; gray	www.wago.com/2004-511
	Item no.: 2004-549 Spacer module; modular; e.g., for bridging commoned terminal blocks; gray	www.wago.com/2004-549
	Item no.: 2004-552 Modular TOPJOB®S connector; modular; for jumper contact slot; 2-pole; 4,00 mm ² ; gray	www.wago.com/2004-552
	Item no.: 2004-553 Modular TOPJOB®S connector; modular; for jumper contact slot; 3-pole; 4,00 mm ² ; gray	www.wago.com/2004-553
	Item no.: 2004-554 Modular TOPJOB®S connector; modular; for jumper contact slot; 4-pole; 4,00 mm ² ; gray	www.wago.com/2004-554
	Item no.: 2004-555 Modular TOPJOB®S connector; modular; for jumper contact slot; 5-pole; 4,00 mm ² ; gray	www.wago.com/2004-555
	Item no.: 2009-174 Test plug adapter; for 4 mm Ø test plugs; for testing TOPJOB®S rail-mounted terminal blocks; gray	www.wago.com/2009-174
	Item no.: 2009-182 Testing tap; for max. 2.5 mm ² ; tool-free connection for individual test wires 0.08 - 2.5 mm; gray	www.wago.com/2009-182
	Item no.: 210-136 Test plug; 2 mm Ø; with 500 mm cable; red	www.wago.com/210-136
tools		
	Item no.: 210-658 Operating tool; Blade: 3.5 x 0.5 mm; with a partially insulated shaft; angled; short; multicoloured	www.wago.com/210-658
	Item no.: 210-720 Operating tool; Blade: 3.5 x 0.5 mm; with a partially insulated shaft; multicoloured	www.wago.com/210-720

Downloads

Documentation

Additional Information

Technical explanations	3 Apr 2019	pdf 2.2 MB	Download
------------------------	------------	---------------	----------

CAD/CAE-Data

CAD data

2D/3D Models 2104-1201	URL	Download
------------------------	-----	----------

CAE data

ZUKEN Portal 2104-1201

Subject to changes. Please also observe the further product documentation!

WAGO Kontakttechnik GmbH & Co. KG
Hansastr. 27
32423 Minden
Phone: +49571 887-0 | Fax: +49571 887-169
Email: info.de@wago.com | Web: www.wago.com

Do you have any questions about our products?
We are always happy to take your call at +49 (571) 887-44222.

Environmental Product Compliance

Compliance Search

Environmental Product Compliance 2104-1201

[URL](#)

[Download](#)

2-conductor through terminal block; with lever and Push-in CAGE CLAMP®; 4 mm²; with test port; side and center marking; for DIN-rail 35 x 15 and 35 x 7.5; Push-in CAGE CLAMP®; 4,00 mm²; gray

Installation Notes

Conductor termination

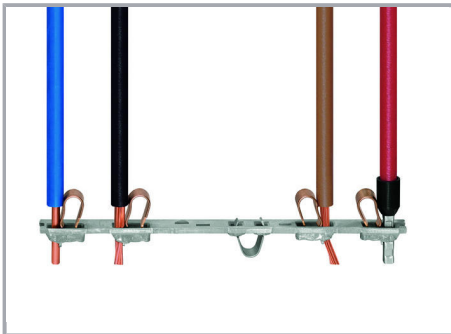

All conductor types at a glance

Product family

TOPJOB® S

TOPJOB® S: In various industrial applications and modern building installations, WAGO's wide and versatile range of rail-mount terminal blocks provides more than just reliable electrical connections.

[Show all products from the family](#)

Subject to changes. Please also observe the further product documentation!