

Data sheet | Item number: 207-1331 **NEW**

Gelbox; for cables; Branch; with gel; 221, 2273 Series; without splicing connectors; Size 1; gray

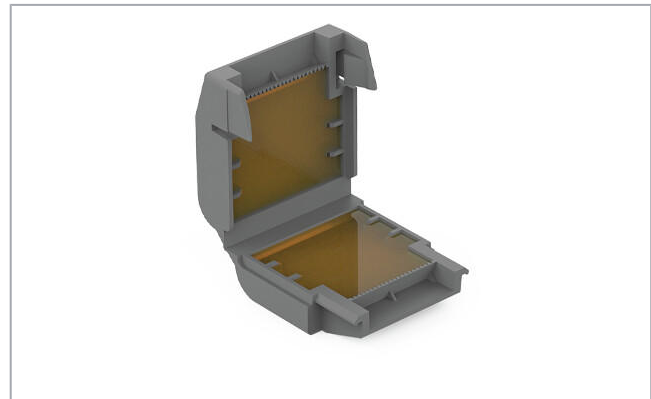

www.wago.com/207-1331

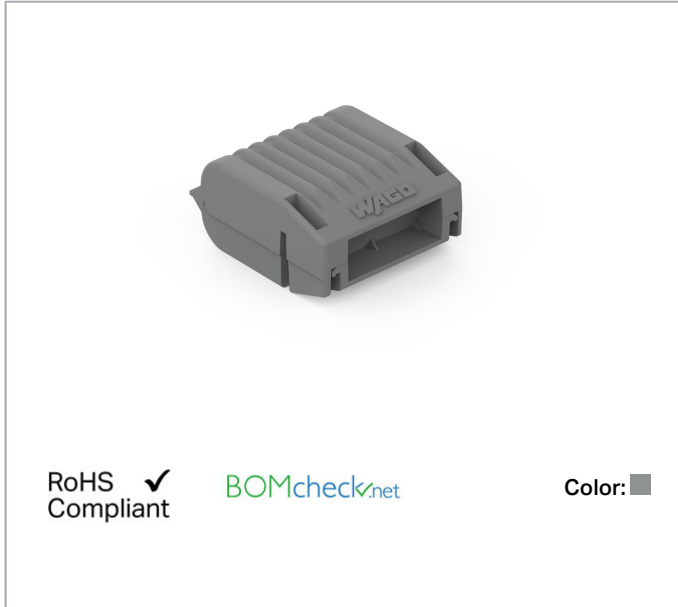

Item description

Note on Packaging Unit (PU) and Subpackaging Unit (SPU):

If you order a full PU, you will receive our eco-friendly, sustainable cardboard blisters packed in a shelf-ready box.

If you order a quantity smaller than a full PU, you will receive the eco-friendly, sustainable cardboard blisters without a shelf-ready box.

Please note the system description for the splicing connectors that can be used.

The Benefits for You:

- Easy, fast and safe to use

—
Subject to changes. Please also observe the further product documentation!

WAGO Kontakttechnik GmbH & Co. KG
Hansastr. 27
32423 Minden
Phone: +49571 887-0 | Fax: +49571 887-169
Email: info.de@wago.com | Web: www.wago.com

Do you have any questions about our products?
We are always happy to take your call at +49 (571) 887-44222.



- Can be used immediately and accessed again later
- Silicon-free
- Label-free
- Suitable for indefinite storage
- The complete system consisting of Gelboxes and WAGO connectors has been VDE-tested and IPX8-certified.

Data

Connection data

| | |
|----------------|------------|
| Actuation type | Verrastung |
|----------------|------------|

Physical data

| | |
|--------|----------------------|
| Width | 33.6 mm / 1.323 inch |
| Height | 17.8 mm / 0.701 inch |
| Depth | 32 mm / 1.26 inch |

Mechanical data

| | |
|-----------------|--------------------------|
| Mounting type | Fliegende Verbindung |
| Protection type | IPx8 (2m/2h) gemäß 60529 |

Material Data

| | |
|------------------|--------------|
| Color | gray |
| Housing material | Polypropylen |
| Weight | 12.7 g |

Environmental Requirements

| | |
|---|---------------|
| Surrounding air temperature (operation) | -55 ... 85 °C |
| Surrounding air temperature (storage) | 0 ... 40 °C |

Commercial data

| | |
|-----------------------|---------------|
| Packaging type | BOX |
| Country of origin | IT |
| GTIN | 4055143997799 |
| Customs tariff number | 85389099990 |

Subject to changes. Please also observe the further product documentation!

WAGO Kontakttechnik GmbH & Co. KG
 Hansastr. 27
 32423 Minden
 Phone: +49571 887-0 | Fax: +49571 887-169
 Email: info.de@wago.com | Web: www.wago.com

Do you have any questions about our products?
 We are always happy to take your call at +49 (571) 887-44222.

Approvals / Certificates

Country specific Approvals

| Logo | Approval | Additional Approval Text | Certificate name |
|--|--|--------------------------|------------------|
|  | VDE VDE Prüf- und Zertifizierungsinstitut | EN 60998 | 400051938 |

Downloads

Documentation

Additional Information

| | | | |
|------------------------|-------------|---------------|----------|
| Technical explanations | Apr 3, 2019 | pdf 2.2 MB | Download |
|------------------------|-------------|---------------|----------|

System Description

| | | | |
|---|--------------|---------------|----------|
| System Description 207 Series Gel boxes | Jul 31, 2020 | pdf 1.1 MB | Download |
|---|--------------|---------------|----------|

Installation Notes

Installation



Gelbox öffnen.

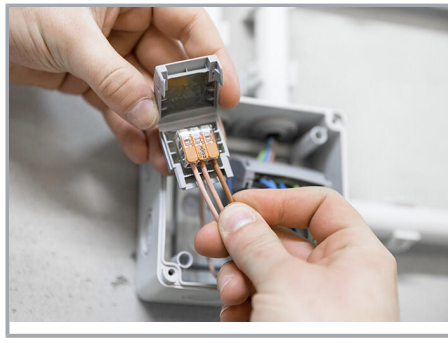

Verdrahtete Klemme in die Gelbox einlegen.

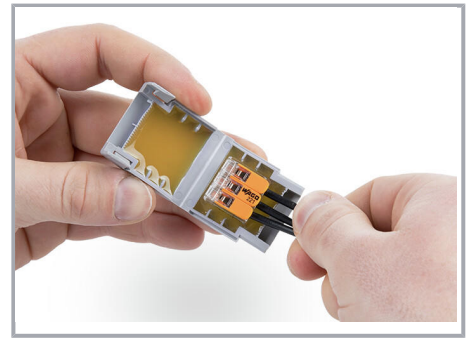

Verdrahtete Klemme in die Gelbox einlegen.

Subject to changes. Please also observe the further product documentation!

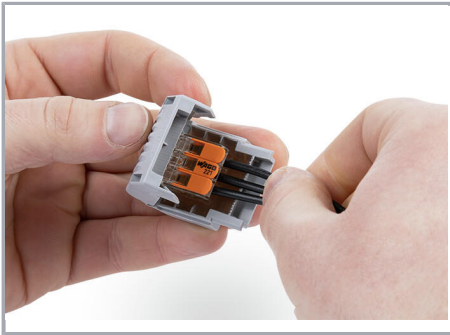

Gelbox schließen.

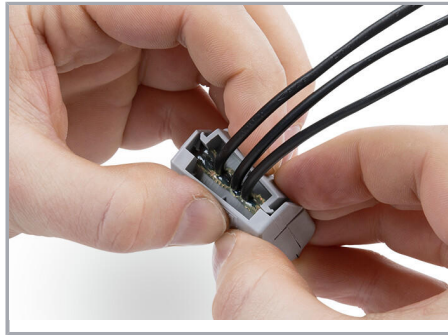

Verrastung sicher verschließen.

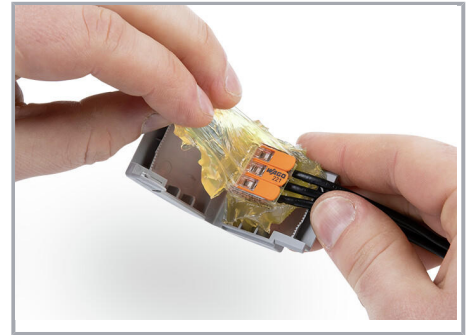

Wiederzugänglich:

- Gelbox öffnen
- Gel entfernen
- Umverdrahten mit neuen Komponenten



Lift the flap and pull the cover perforation forward.



Press in the perforation on the sides.



Tear off the cover from the perforation.



As a counter display: Bend the rear flap at the fold, straighten it and fix it in the cardboard cut-out



If the flap is not required, tear off from the perforation.

Subject to changes. Please also observe the further product documentation!