

**Data sheet | Item number: 2050-311**

2-conductor miniature through terminal block; with operating slots; 1 mm<sup>2</sup>; with test port; side and center marking; with snap-in mounting foot; Push-in CAGE CLAMP®; 1,00 mm<sup>2</sup>; gray

[www.wago.com/2050-311](http://www.wago.com/2050-311)

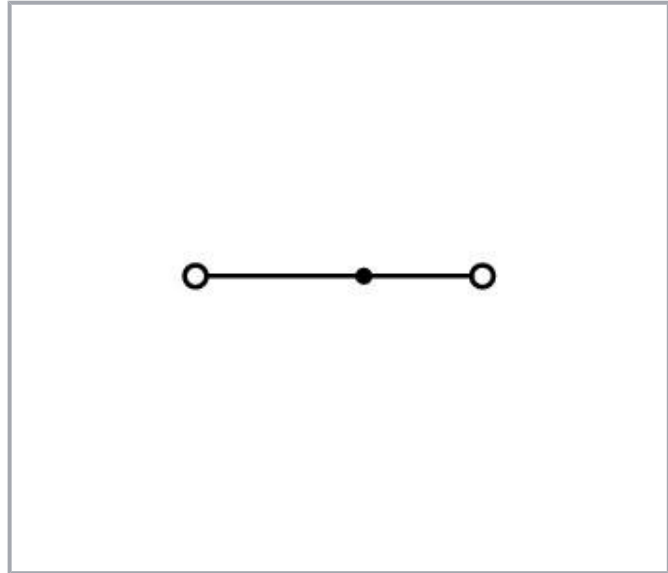
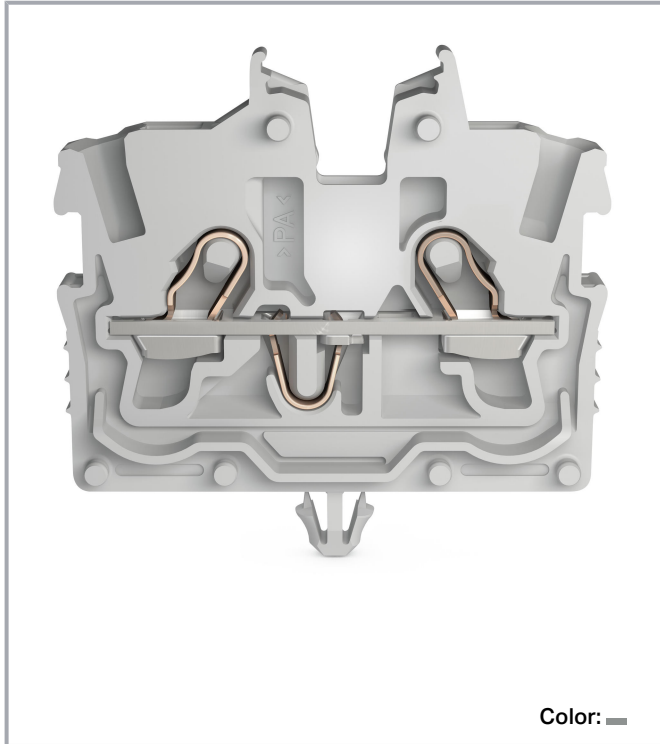

Subject to changes. Please also observe the further product documentation!

WAGO Kontakttechnik GmbH & Co. KG  
Hansastr. 27  
32423 Minden  
Phone: +49571 887-0 | Fax: +49571 887-169  
Email: [info.de@wago.com](mailto:info.de@wago.com) | Web: [www.wago.com](http://www.wago.com)

Do you have any questions about our products?  
We are always happy to take your call at +49 (571) 887-44222.

Modular terminal blocks and terminal strips with snap-in mounting feet

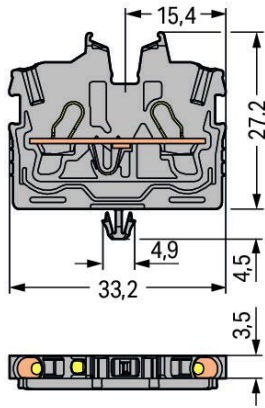

2-pole

Pole number > 2

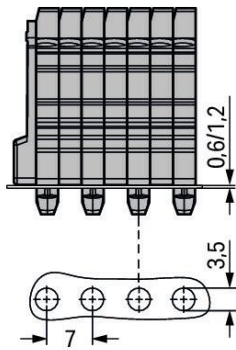
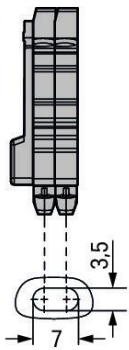

## Data

### Electrical data

### Ratings per IEC/EN

| Ratings per                 | IEC/EN 60947-7-1  |
|-----------------------------|---|
| Nominal voltage (III/3)     | 500 V   |
| Rated surge voltage (III/3) | 6 kV  |
| Rated current               | 13.5 A  |
| Rated current 2             | 17.5 A  |
| Legend (ratings)            | (III / 3) ≙ Overvoltage category III / Pollution degree 3 |

Subject to changes. Please also observe the further product documentation!

WAGO Kontakttechnik GmbH & Co. KG  
 Hansastr. 27  
 32423 Minden  
 Phone: +49571 887-0 | Fax: +49571 887-169  
 Email: [info.de@wago.com](mailto:info.de@wago.com) | Web: [www.wago.com](http://www.wago.com)

Do you have any questions about our products?  
 We are always happy to take your call at +49 (571) 887-44222.



## Ratings per UL

|                                |         |
|--------------------------------|---------|
| Approvals per                  | UL 1059 |
| Rated voltage UL (Use Group B) | 300 V   |
| Rated current UL (Use Group B) | 10 A    |
| Rated voltage UL (Use Group C) | 300 V   |
| Rated current UL (Use Group C) | 10 A    |

## Ratings per CSA

|                                 |              |
|---------------------------------|--------------|
| Approvals per                   | C22.2 No 158 |
| Rated voltage CSA (Use Group B) | 300 V        |
| Rated current CSA (Use Group B) | 10 A         |
| Rated voltage CSA (Use Group C) | 300 V        |
| Rated current CSA (Use Group C) | 10 A         |

## Ex information

|                                     |   |
|-------------------------------------|---|
| Ratings per                         | ATEX: PTB 19 ATEX 1019 U / IECEx: PTB 19.0050U (Ex eb IIC Gb) |
| Rated voltage EN (Ex e II)          | 352 V   |
| Rated current (Ex e II)             | 13.5 A  |
| Rated current (Ex e II) with jumper | 12 A  |

## Connection data

|  |   |
|--|---|
| Connection technology                                      | Push-in CAGE CLAMP®   |
| Actuation type   | Push-in<br>Operating tool   |
| Connectable conductor materials                            | Copper<br>Copper  |
| Nominal cross-section                                      | 1 mm <sup>2</sup>   |
| Solid conductor  | 0.14 ... 1.5 mm <sup>2</sup> / 24 ... 16 AWG  |
| Solid conductor; push-in termination                       | 0.5 ... 1.5 mm <sup>2</sup> / 20 ... 16 AWG   |
| Fine-stranded conductor                                    | 0.14 ... 1.5 mm <sup>2</sup> / 24 ... 16 AWG  |
| Fine-stranded conductor; with insulated ferrule            | 0.14 ... 0.75 mm <sup>2</sup> / 24 ... 18 AWG   |
| Fine-stranded conductor; with ferrule; push-in termination | 0.5 ... 0.75 mm <sup>2</sup> / 20 ... 18 AWG  |
| Note (conductor cross-section)                             | Depending on the conductor characteristic, a conductor with a smaller cross-section can also be inserted via push-in termination. |
| Strip length   | 9 ... 11 mm / 0.35 ... 0.43 inch  |
| Total number of connection points                          | 2   |
| Total number of potentials                                 | 1   |

Subject to changes. Please also observe the further product documentation!

WAGO Kontakttechnik GmbH & Co. KG  
 Hansastr. 27  
 32423 Minden  
 Phone: +49571 887-0 | Fax: +49571 887-169  
 Email: [info.de@wago.com](mailto:info.de@wago.com) | Web: [www.wago.com](http://www.wago.com)

Do you have any questions about our products?  
 We are always happy to take your call at +49 (571) 887-44222.

|                        |                    |
|------------------------|--------------------|
| Number of levels       | 1                  |
| Wiring type            | Front-entry wiring |
| Number of jumper slots | 1                  |

### Physical data

|                         |                      |
|-------------------------|----------------------|
| Width                   | 3.5 mm / 0.138 inch  |
| Height from the surface | 27.2 mm / 1.071 inch |
| Depth                   | 33.2 mm / 1.307 inch |

### Mechanical data

|               |                     |
|---------------|---------------------|
| Design        | horizontal type     |
| Mounting type | Snap-in foot        |
| Marking level | Center/side marking |

### Material data



|                             |                  |
|-----------------------------|------------------|
| Color                       | gray             |
| Insulation material         | Polyamide (PA66) |
| Flammability class per UL94 | V0               |
| Weight                      | 2.3 g            |

### Commercial data

|                       |               |
|-----------------------|---------------|
| Packaging type        | BOX           |
| Country of origin     | DE            |
| GTIN                  | 4055143964760 |
| Customs tariff number | 85369010000   |

### Approvals / Certificates

#### Ex-Approvals



| Logo   | Approval                                      | Additional Approval Text | Certificate name  |
|--|---|--------------------------|---|
|  | ATEX<br>Physikalisch Technische Bundesanstalt | EN IEC 60079-0           | PTB 19 ATEX 1019<br>U (II 2G Ex eb IIC Gb<br>or I M 2 EX eb I Mb) |
|  | CCCEX<br>CQST/CNEX                            | CNCA-C23-01              | 2020312313000289  |
| <b>IECEX</b>   |   | IEC 60079                | IECEX PTB 19.0050   |

Subject to changes. Please also observe the further product documentation!

Physikalisch Technische Bundesanstalt

U (Ex eb IIC Gb or  
EX eb I Mb)

## Country specific Approvals

| Logo   | Approval                              | Additional Approval Text | Certificate name |
|--|---------------------------------------|--------------------------|------------------|
|  | CCA<br>DEKRA Certification B.V.       | EN 60998                 | NTR NL<br>7840   |
|  | CSA<br>CSA                            | C22.2 No. 158            | 80034182         |
|  | KEMA/KEUR<br>DEKRA Certification B.V. | EN 60998                 | 71-<br>113957    |

## UL-Approvals

| Logo   | Approval                                | Additional Approval Text | Certificate name    |
|--|---|--------------------------|---------------------|
|  | cURus<br>Underwriters Laboratories Inc. | UL 1059                  | E45172-<br>20200212 |

## Counterpart



Item no.2050-321  
2-conductor miniature through terminal block; with operating slots; 1 mm<sup>2</sup>; with test port; side and center marking; Center terminal block without snap-in mounting foot, without mounting flange; Push-in CAGE CLAMP®; 1,00 mm<sup>2</sup>; gray

[www.wago.com/2050-321](http://www.wago.com/2050-321)

## Required accessories



## End plate

|   |   |  |
|---|---|--|
|  | Item no.: 2050-391<br>End plate; for terminal blocks with snap-in mounting foot; 3.4 mm thick; gray | <a href="http://www.wago.com/2050-391">www.wago.com/2050-391</a> |
|---|---|--|



Subject to changes. Please also observe the further product documentation!

## Compatible products



### check

|   |   |  |
|---|---|--|
|  | <b>Item no.: 2009-174</b><br>Test plug adapter; for 4 mm Ø test plugs; for testing TOPJOB®S rail-mounted terminal blocks; gray              | <a href="http://www.wago.com/2009-174">www.wago.com/2009-174</a> |
|  | <b>Item no.: 2009-182</b><br>Testing tap; for max. 2.5 mm <sup>2</sup> ; tool-free connection for individual test wires 0.08 - 2.5 mm; gray | <a href="http://www.wago.com/2009-182">www.wago.com/2009-182</a> |
|  | <b>Item no.: 210-136</b><br>Test plug; 2 mm Ø; with 500 mm cable; red   | <a href="http://www.wago.com/210-136">www.wago.com/210-136</a>   |



### assembling

|   |   |  |
|---|---|--|
|  | <b>Item no.: 209-120</b><br>Mounting foot; can be snapped on terminal blocks with snap-in mounting foot; for mounting on relay-modules; 6.4 mm wide; gray | <a href="http://www.wago.com/209-120">www.wago.com/209-120</a> |
|  | <b>Item no.: 209-137</b><br>Mounting adapter; can be used as end stop; 6.5 mm wide; gray  | <a href="http://www.wago.com/209-137">www.wago.com/209-137</a> |



### Push-In type wire jumper

|   |  |  |
|---|--|--|
|    | <b>Item no.: 2009-402</b><br>Push-in type wire jumper; 0.75 mm <sup>2</sup> ; insulated; 60 mm long; gray  | <a href="http://www.wago.com/2009-402">www.wago.com/2009-402</a> |
|   | <b>Item no.: 2009-404</b><br>Push-in type wire jumper; 0.75 mm <sup>2</sup> ; insulated; 110 mm long; gray | <a href="http://www.wago.com/2009-404">www.wago.com/2009-404</a> |
|  | <b>Item no.: 2009-406</b><br>Push-in type wire jumper; 0.75 mm <sup>2</sup> ; insulated; 250 mm long; gray | <a href="http://www.wago.com/2009-406">www.wago.com/2009-406</a> |

### ferrule













|   |  |  |
|---|--|--|
|  | <b>Item no.: 216-241</b><br>Ferrule; Sleeve for 0.5 mm <sup>2</sup> / 20 AWG; insulated; electro-tin plated; electrolytic copper; gastight crimped; acc. to DIN 46228, Part 4/09.90; white | <a href="http://www.wago.com/216-241">www.wago.com/216-241</a> |
|  | <b>Item no.: 216-242</b><br>Ferrule; Sleeve for 0.75 mm <sup>2</sup> / 18 AWG; insulated; electro-tin plated; electrolytic copper; gastight crimped; acc. to DIN 46228, Part 4/09.90; gray | <a href="http://www.wago.com/216-242">www.wago.com/216-242</a> |
|  | <b>Item no.: 216-243</b><br>Ferrule; Sleeve for 1 mm <sup>2</sup> / AWG 18; insulated; electro-tin plated; electrolytic copper; gastight crimped; acc. to DIN 46228, Part 4/09.90; red     | <a href="http://www.wago.com/216-243">www.wago.com/216-243</a> |

### tools















|   |  |  |
|---|--|--|
|  | <b>Item no.: 210-647</b><br>Operating tool; Blade: 2.5 x 0.4 mm; with a partially insulated shaft; multicoloured | <a href="http://www.wago.com/210-647">www.wago.com/210-647</a> |
|  | <b>Item no.: 210-648</b><br>Operating tool; Blade: 2.5 x 0.4 mm; with a partially insulated shaft; angled; short | <a href="http://www.wago.com/210-648">www.wago.com/210-648</a> |
|  | <b>Item no.: 210-719</b><br>Operating tool; Blade: 2.5 x 0.4 mm; with a partially insulated shaft                | <a href="http://www.wago.com/210-719">www.wago.com/210-719</a> |

### Jumper

Subject to changes. Please also observe the further product documentation!











|  |  |  |
|--|--|--|
|    | <b>Item no.: 2000-402</b><br>Jumper; 2-way; insulated; light gray                    | <a href="http://www.wago.com/2000-402">www.wago.com/2000-402</a>                 |
|    | <b>Item no.: 2000-402/000-005</b><br>Jumper; 2-way; insulated; red                   | <a href="http://www.wago.com/2000-402/000-005">www.wago.com/2000-402/000-005</a> |
|    | <b>Item no.: 2000-402/000-006</b><br>Jumper; 2-way; insulated; blue                  | <a href="http://www.wago.com/2000-402/000-006">www.wago.com/2000-402/000-006</a> |
|    | <b>Item no.: 2000-402/000-018</b><br>Jumper; 2-way; insulated; yellow-green          | <a href="http://www.wago.com/2000-402/000-018">www.wago.com/2000-402/000-018</a> |
|    | <b>Item no.: 2000-403</b><br>Jumper; 3-way; insulated; light gray                    | <a href="http://www.wago.com/2000-403">www.wago.com/2000-403</a>                 |
|    | <b>Item no.: 2000-403/000-005</b><br>Jumper; 3-way; insulated; red                   | <a href="http://www.wago.com/2000-403/000-005">www.wago.com/2000-403/000-005</a> |
|    | <b>Item no.: 2000-403/000-006</b><br>Jumper; 3-way; insulated; blue                  | <a href="http://www.wago.com/2000-403/000-006">www.wago.com/2000-403/000-006</a> |
|   | <b>Item no.: 2000-404</b><br>Jumper; 4-way; insulated; light gray                    | <a href="http://www.wago.com/2000-404">www.wago.com/2000-404</a>                 |
|  | <b>Item no.: 2000-404/000-005</b><br>Jumper; 4-way; insulated; red                   | <a href="http://www.wago.com/2000-404/000-005">www.wago.com/2000-404/000-005</a> |
|  | <b>Item no.: 2000-404/000-006</b><br>Jumper; 4-way; insulated; blue                  | <a href="http://www.wago.com/2000-404/000-006">www.wago.com/2000-404/000-006</a> |
|  | <b>Item no.: 2000-405</b><br>Jumper; 5-way; insulated; light gray                    | <a href="http://www.wago.com/2000-405">www.wago.com/2000-405</a>                 |
|  | <b>Item no.: 2000-405/000-005</b><br>Jumper; 5-way; insulated; red                   | <a href="http://www.wago.com/2000-405/000-005">www.wago.com/2000-405/000-005</a> |
|  | <b>Item no.: 2000-405/000-006</b><br>Jumper; 5-way; insulated; blue                  | <a href="http://www.wago.com/2000-405/000-006">www.wago.com/2000-405/000-006</a> |
|  | <b>Item no.: 2000-405/011-000</b><br>Star point jumper; 3-way; insulated; light gray | <a href="http://www.wago.com/2000-405/011-000">www.wago.com/2000-405/011-000</a> |

Subject to changes. Please also observe the further product documentation!





|  |  |  |
|--|--|--|
|    | <b>Item no.: 2000-406</b><br>Jumper; 6-way; insulated; light gray        | <a href="http://www.wago.com/2000-406">www.wago.com/2000-406</a>                 |
|    | <b>Item no.: 2000-406/000-005</b><br>Jumper; 6-way; insulated; red       | <a href="http://www.wago.com/2000-406/000-005">www.wago.com/2000-406/000-005</a> |
|    | <b>Item no.: 2000-406/000-006</b><br>Jumper; 6-way; insulated; blue      | <a href="http://www.wago.com/2000-406/000-006">www.wago.com/2000-406/000-006</a> |
|    | <b>Item no.: 2000-406/020-000</b><br>Delta jumper; insulated; light gray | <a href="http://www.wago.com/2000-406/020-000">www.wago.com/2000-406/020-000</a> |
|    | <b>Item no.: 2000-407</b><br>Jumper; 7-way; insulated; light gray        | <a href="http://www.wago.com/2000-407">www.wago.com/2000-407</a>                 |
|    | <b>Item no.: 2000-407/000-005</b><br>Jumper; 7-way; insulated; red       | <a href="http://www.wago.com/2000-407/000-005">www.wago.com/2000-407/000-005</a> |
|    | <b>Item no.: 2000-407/000-006</b><br>Jumper; 7-way; insulated; blue      | <a href="http://www.wago.com/2000-407/000-006">www.wago.com/2000-407/000-006</a> |
|   | <b>Item no.: 2000-408</b><br>Jumper; 8-way; insulated; light gray        | <a href="http://www.wago.com/2000-408">www.wago.com/2000-408</a>                 |
|  | <b>Item no.: 2000-408/000-005</b><br>Jumper; 8-way; insulated; red       | <a href="http://www.wago.com/2000-408/000-005">www.wago.com/2000-408/000-005</a> |
|  | <b>Item no.: 2000-408/000-006</b><br>Jumper; 8-way; insulated; blue      | <a href="http://www.wago.com/2000-408/000-006">www.wago.com/2000-408/000-006</a> |
|  | <b>Item no.: 2000-409</b><br>Jumper; 9-way; insulated; light gray        | <a href="http://www.wago.com/2000-409">www.wago.com/2000-409</a>                 |
|  | <b>Item no.: 2000-409/000-005</b><br>Jumper; 9-way; insulated; red       | <a href="http://www.wago.com/2000-409/000-005">www.wago.com/2000-409/000-005</a> |
|  | <b>Item no.: 2000-409/000-006</b><br>Jumper; 9-way; insulated; blue      | <a href="http://www.wago.com/2000-409/000-006">www.wago.com/2000-409/000-006</a> |
|  | <b>Item no.: 2000-410</b><br>Jumper; 10-way; insulated; light gray       | <a href="http://www.wago.com/2000-410">www.wago.com/2000-410</a>                 |
|  | <b>Item no.: 2000-410/000-005</b><br>Jumper; 10-way; insulated; red      | <a href="http://www.wago.com/2000-410/000-005">www.wago.com/2000-410/000-005</a> |

Subject to changes. Please also observe the further product documentation!







|  |   |  |
|--|---|--|
|     | <b>Item no.: 2000-410/000-006</b><br>Jumper; 10-way; insulated; blue      | <a href="http://www.wago.com/2000-410/000-006">www.wago.com/2000-410/000-006</a> |
|    | <b>Item no.: 2000-433</b><br>Jumper; from 1 to 3; insulated; light gray   | <a href="http://www.wago.com/2000-433">www.wago.com/2000-433</a>                 |
|    | <b>Item no.: 2000-433/000-005</b><br>Jumper; from 1 to 3; insulated; red  | <a href="http://www.wago.com/2000-433/000-005">www.wago.com/2000-433/000-005</a> |
|    | <b>Item no.: 2000-433/000-006</b><br>Jumper; from 1 to 3; insulated; blue | <a href="http://www.wago.com/2000-433/000-006">www.wago.com/2000-433/000-006</a> |
|    | <b>Item no.: 2000-434</b><br>Jumper; from 1 to 4; insulated; light gray   | <a href="http://www.wago.com/2000-434">www.wago.com/2000-434</a>                 |
|    | <b>Item no.: 2000-435</b><br>Jumper; from 1 to 5; insulated; light gray   | <a href="http://www.wago.com/2000-435">www.wago.com/2000-435</a>                 |
|    | <b>Item no.: 2000-436</b><br>Jumper; from 1 to 6; insulated; light gray   | <a href="http://www.wago.com/2000-436">www.wago.com/2000-436</a>                 |
|    | <b>Item no.: 2000-437</b><br>Jumper; from 1 to 7; insulated; light gray   | <a href="http://www.wago.com/2000-437">www.wago.com/2000-437</a>                 |
|  | <b>Item no.: 2000-438</b><br>Jumper; from 1 to 8; insulated; light gray   | <a href="http://www.wago.com/2000-438">www.wago.com/2000-438</a>                 |
|  | <b>Item no.: 2000-439</b><br>Jumper; from 1 to 9; insulated; light gray   | <a href="http://www.wago.com/2000-439">www.wago.com/2000-439</a>                 |
|  | <b>Item no.: 2000-440</b><br>Jumper; from 1 to 10; insulated; light gray  | <a href="http://www.wago.com/2000-440">www.wago.com/2000-440</a>                 |

**Marking accessories**

|   |  |  |
|---|--|--|
|  | <b>Item no.: 2009-110</b><br>Marking strips; for Smart Printer; on reel; not stretchable; plain; snap-on type; white | <a href="http://www.wago.com/2009-110">www.wago.com/2009-110</a>                 |
|  | <b>Item no.: 2009-113</b><br>WMB-Inline; for Smart Printer; 2300 pieces on roll; plain; snap-on type; white          | <a href="http://www.wago.com/2009-113">www.wago.com/2009-113</a>                 |
|  | <b>Item no.: 2009-113/000-002</b><br>WMB-Inline; for Smart Printer; 2300 pieces on roll; plain; snap-on type; yellow | <a href="http://www.wago.com/2009-113/000-002">www.wago.com/2009-113/000-002</a> |
|  | <b>Item no.: 2009-113/000-005</b><br>WMB-Inline; for Smart Printer; 2300 pieces on roll; plain; snap-on type; red    | <a href="http://www.wago.com/2009-113/000-005">www.wago.com/2009-113/000-005</a> |

Subject to changes. Please also observe the further product documentation!



|  |   |  |
|--|---|--|
| *  | <b>Item no.: 2009-113/000-006</b><br>WMB-Inline; for Smart Printer; 2300 pieces on roll; plain; snap-on type; blue        | <a href="http://www.wago.com/2009-113/000-006">www.wago.com/2009-113/000-006</a> |
| *  | <b>Item no.: 2009-113/000-007</b><br>WMB-Inline; for Smart Printer; 2300 pieces on roll; plain; snap-on type; gray        | <a href="http://www.wago.com/2009-113/000-007">www.wago.com/2009-113/000-007</a> |
| *  | <b>Item no.: 2009-113/000-012</b><br>WMB-Inline; for Smart Printer; 2300 pieces on roll; plain; snap-on type; orange      | <a href="http://www.wago.com/2009-113/000-012">www.wago.com/2009-113/000-012</a> |
| *  | <b>Item no.: 2009-113/000-017</b><br>WMB-Inline; for Smart Printer; 2300 pieces on roll; plain; snap-on type; light green | <a href="http://www.wago.com/2009-113/000-017">www.wago.com/2009-113/000-017</a> |
| *  | <b>Item no.: 2009-113/000-023</b><br>WMB-Inline; for Smart Printer; 2300 pieces on roll; plain; snap-on type; green       | <a href="http://www.wago.com/2009-113/000-023">www.wago.com/2009-113/000-023</a> |
| *  | <b>Item no.: 2009-113/000-024</b><br>WMB-Inline; for Smart Printer; 2300 pieces on roll; plain; snap-on type; violet      | <a href="http://www.wago.com/2009-113/000-024">www.wago.com/2009-113/000-024</a> |
|    | <b>Item no.: 2009-191</b><br>Group marker carrier   | <a href="http://www.wago.com/2009-191">www.wago.com/2009-191</a>                 |
|  | <b>Item no.: 793-3501</b><br>WMB marking card; as card; plain; snap-on type; white  | <a href="http://www.wago.com/793-3501">www.wago.com/793-3501</a>                 |
| <b>Protective Warning Marker</b>   |   |  |
|  | <b>Item no.: 2000-115</b><br>Protective warning marker; with high-voltage symbol, black; for 5 terminal blocks; yellow    | <a href="http://www.wago.com/2000-115">www.wago.com/2000-115</a>                 |
| <b>Carrier rail</b>  |   |  |
|  | <b>Item no.: 210-154</b><br>Aluminum carrier rail; 1000 mm long; 18 mm wide; 7 mm high; silver-colored                    | <a href="http://www.wago.com/210-154">www.wago.com/210-154</a>                   |

**Downloads**

**Documentation**

**Additional Information**

|                        |            |               |          |
|------------------------|------------|---------------|----------|
| Technical explanations | 3 Apr 2019 | pdf<br>2.2 MB | Download |
|------------------------|------------|---------------|----------|

**CAD/CAE-Data**

**CAD data**

2D/3D Models 2050-311

Subject to changes. Please also observe the further product documentation!

WAGO Kontakttechnik GmbH & Co. KG  
 Hansastr. 27  
 32423 Minden  
 Phone: +49571 887-0 | Fax: +49571 887-169  
 Email: [info.de@wago.com](mailto:info.de@wago.com) | Web: [www.wago.com](http://www.wago.com)

Do you have any questions about our products?  
 We are always happy to take your call at +49 (571) 887-44222.

|                            |                     |                          |
|----------------------------|---------------------|--------------------------|
|                            | <a href="#">URL</a> | <a href="#">Download</a> |
| <b>CAE data</b>            |                     |                          |
| ZUKEN Portal 2050-311      | <a href="#">URL</a> | <a href="#">Download</a> |
|                            | <a href="#">URL</a> | <a href="#">Download</a> |
| EPLAN Data Portal 2050-311 | <a href="#">URL</a> | <a href="#">Download</a> |

## Environmental Product Compliance

### Compliance Search

|   |                     |                          |
|---|---------------------|--------------------------|
| Environmental Product Compliance 2050-311   | <a href="#">URL</a> | <a href="#">Download</a> |
| 2-conductor miniature through terminal block; with operating slots; 1 mm <sup>2</sup> ; with test port; side and center marking; with snap-in mounting foot; Push-in CAGE CLAMP®; 1,00 mm <sup>2</sup> ; gray |                     |                          |

## Installation Notes

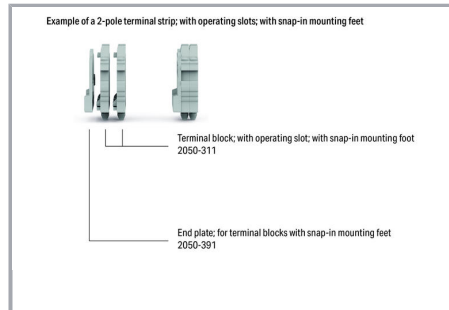
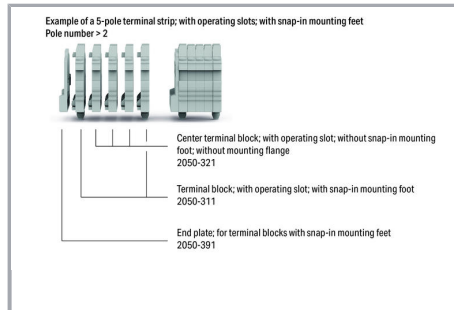

## Conductor termination

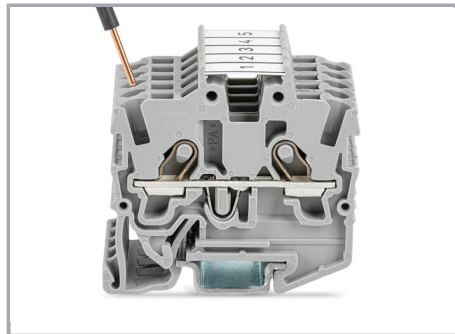

Insert solid conductors via push-in termination.



Insert ferruled conductors via push-in termination.

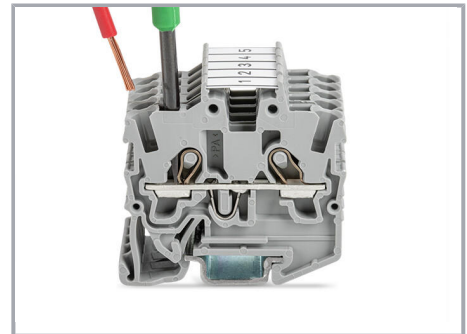

Insert fine-stranded conductors via operating tool.

Subject to changes. Please also observe the further product documentation!

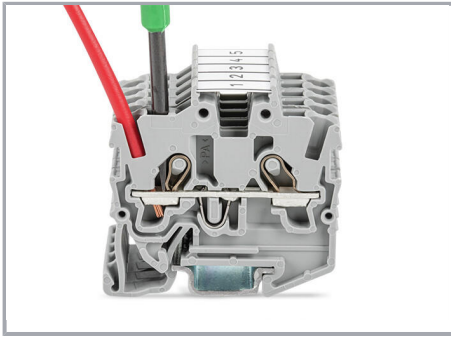

Remove all conductors via operating tool.

### Commoning

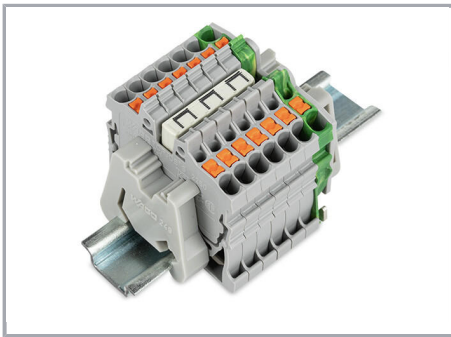

Insert a jumper (delta jumper) and push down until it hits the backstop (picture shows terminal blocks with push-buttons).

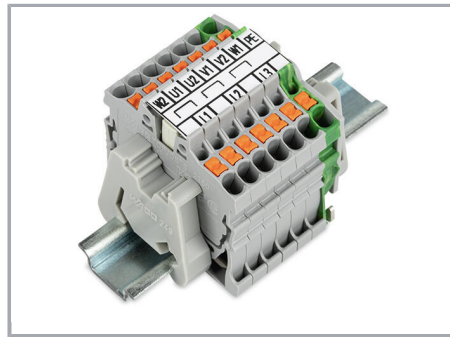

Marking strip (2009-110) inserted in the marking slot with jumper symbols of the inserted jumper (picture shows terminal blocks with push-buttons)

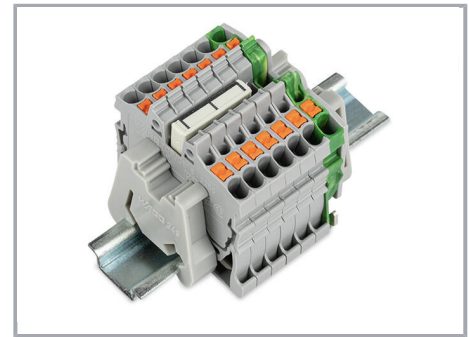

Insert a jumper (star point jumper) and push down until it hits the backstop (picture shows terminal blocks with push-buttons).

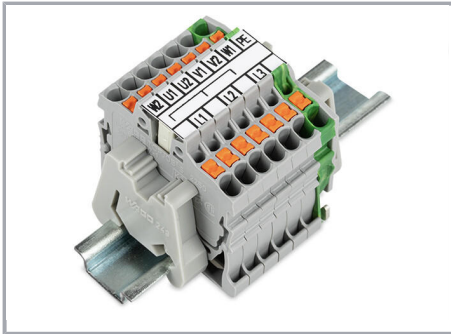

Marking strip (2009-110) inserted in the marking slot with jumper symbols of the inserted jumper (2000-405/011-000 Delta Jumper) (picture shows terminal blocks with push-buttons)

### Testing

Subject to changes. Please also observe the further product documentation!



Testing with a 2 mm Ø 210-136 Test Plug (max. 42 V).

### Installation

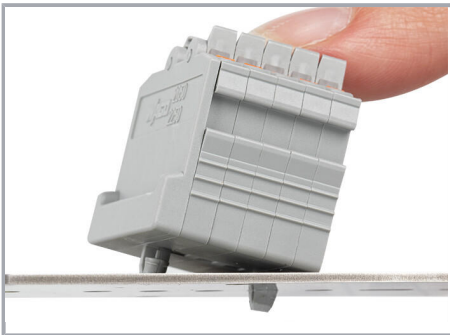

Mounting a terminal strip with snap-in feet into holes.



Mounting a terminal strip with snap-in feet onto aluminum rail.

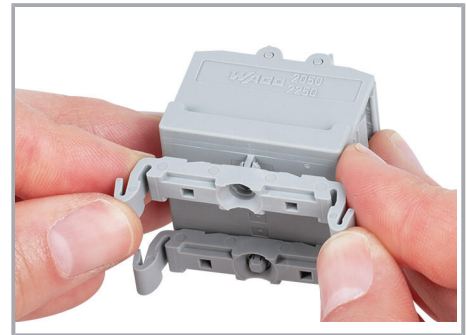

Terminal strip; with snap-in mounting feet  
Snapping a mounting foot (209-120)  
(Distance between mounting feet: approx. 20 ... 25 mm)

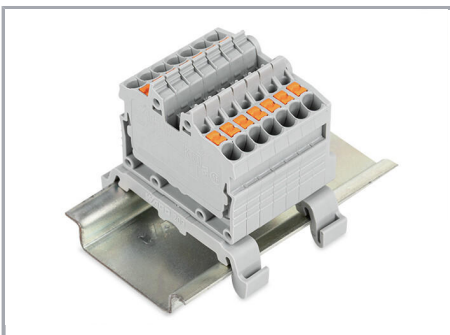

Terminal strip; with snap-in mounting feet; for DIN-35 rail (209-120 Mounting Foot) (picture shows terminal blocks with push-buttons)

### Marking

Subject to changes. Please also observe the further product documentation!

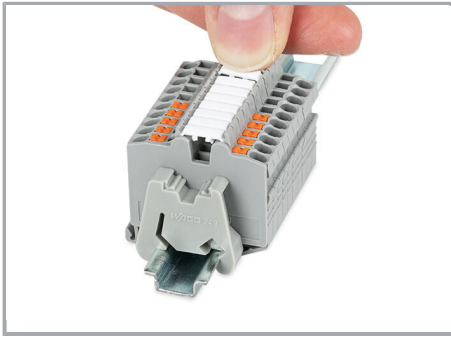

Snapping a WMB marking strip into a marker slot.

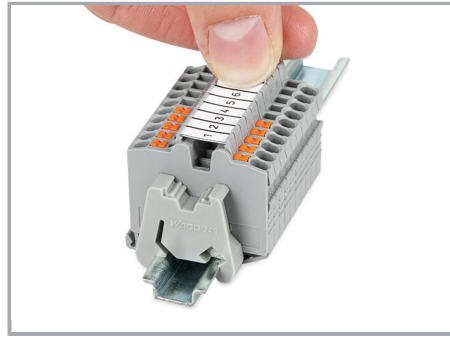

Snapping a marking strip (2009-110) into a marker slot.

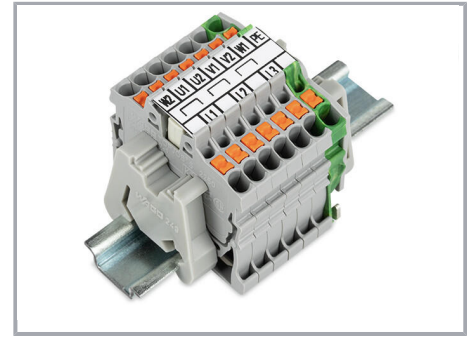

Marking strip (2009-110) inserted in the marking slot with jumper symbols of the inserted jumper (picture shows terminal blocks with push-buttons)

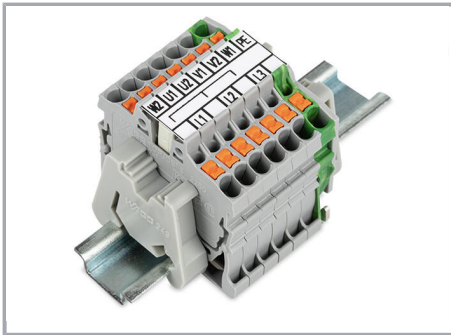

Marking strip (2009-110) inserted in the marking slot with jumper symbols of the inserted jumper (2000-405/011-000 Delta Jumper) (picture shows terminal blocks with push-buttons)

## Product family

### TOPJOB® S

TOPJOB® S: In various industrial applications and modern building installations, WAGO's wide and versatile range of rail-mount terminal blocks provides more than just reliable electrical connections.

[Show all products from the family](#)

Subject to changes. Please also observe the further product documentation!