

164SL11

✓ ACTIVE

Alcoswitch | Alcoswitch Command

TE Internal #: 2-1437569-5

Alcoswitch Command, Push Button Switches, Switch, Single Actuator, Illuminated, Snap Action, Tactile, Momentary, 5 A, 250 VAC, 20 VDC / 24 VDC, .4

[View on TE.com >](#)



Relays, Contactors & Switches > Switches > Push Button Switches



Push Button Switch Product Type: **Switch**

Number of Actuators: **Single**

Illuminated: **Yes**

Process Sealed: **No**

Snap Action: **With**

Features

Product Type Features

Switch Type	Pushbutton
Dust Proof	No
Push Button Switch Product Type	Switch
Illuminated	Yes
Actuator Style	Square

Configuration Features

Ganged	No
Panel Cutout Size	16 (Diameter) mm
Number of Actuators	Single
Snap Action	With
Tactile	Yes
Operating Function	Momentary

Electrical Characteristics

Push Button Switch Voltage Rating	20 VDC, 24 VDC
Push Button Switch Power Rating	.4

Body Features

Seal Type	IP65
-----------	------

Contact Features



Type of Contact	1 NO & 1 NC
Push Button Switch Contact Current Rating	5 A
Switch Contact Plating Material	Gold

Mechanical Attachment

Mounting Angle	Vertical
Push Button Switch Mounting Type	Panel

Housing Features

Low Profile	No
Process Sealed	No

Dimensions

Button Width	15 mm [.59 in]
--------------	----------------

Usage Conditions

Oil-Tight	No
-----------	----

Operation/Application

For Use With	Lens Model 64S(*) (where * equals (2) Red, (3) Orange, (4) Yellow, (5) Green, (6) Blue, or (9) White., T1 3/4 midget flanged base lamps.
--------------	--

Other

Comment	Order Lamp Separately., Order Lens Set Separately.
---------	--

Product Compliance

[For compliance documentation, visit the product page on TE.com>](#)

EU RoHS Directive 2011/65/EU	Compliant
EU ELV Directive 2000/53/EC	Compliant
China RoHS 2 Directive MIIT Order No 32, 2016	No Restricted Materials Above Threshold
EU REACH Regulation (EC) No. 1907/2006	Current ECHA Candidate List: JAN 2022 (223) Candidate List Declared Against: JAN 2021 (211) SVHC > Threshold: Not Yet Reviewed
Halogen Content	Not Yet Reviewed for halogen content
Solder Process Capability	Not applicable for solder process capability



Product Compliance Disclaimer

This information is provided based on reasonable inquiry of our suppliers and represents our current actual knowledge based on the information they provided. This information is subject to change. The part numbers that TE has identified as EU RoHS compliant have a maximum concentration of 0.1% by weight in homogenous materials for lead, hexavalent chromium, mercury, PBB, PBDE, DBP, BBP, DEHP, DIBP, and 0.01% for cadmium, or qualify for an exemption to these limits as defined in the Annexes of Directive 2011/65/EU (RoHS2). Finished electrical and electronic equipment products will be CE marked as required by Directive 2011/65/EU. Components may not be CE marked. Additionally, the part numbers that TE has identified as EU ELV compliant have a maximum concentration of 0.1% by weight in homogenous materials for lead, hexavalent chromium, and mercury, and 0.01% for cadmium, or qualify for an exemption to these limits as defined in the Annexes of Directive 2000/53/EC (ELV). Regarding the REACH Regulation, the information TE provides on SVHC in articles for this part number is based on the latest European Chemicals Agency (ECHA) 'Guidance on requirements for substances in articles' posted at this URL: <https://echa.europa.eu/guidance-documents/guidance-on-reach>

Compatible Parts



TE Part # 3-1437569-0
164SL522=SQ ILL PP 2NO&2NC



TE Part # 3-1437569-5
164TL22=RECT MOM ILLUM PB 2NO&



TE Part # 7-1437569-9
64S2=COLOR PB CAP RED SQ



TE Part # 8-1437569-4
64S9=COLOR PB CAP WHITE SQ



TE Part # 8-1437569-7
64T4=COLOR PB CAP YELLOW RECT



TE Part # 1-1437569-3
164J2B11=REC 2-POS KY PLL BOTH



TE Part # 3-1437569-9
164TL522=RECT PP ILL PB 2NO&2N



TE Part # 1-1437569-2
164J2A22=2-POS KEYLK MAINT KYP



TE Part # 2-1437569-0
164P2B11=RECT 2-POS SELECT INO



TE Part # 2-1437569-7
164SL33=ILL SQ MOM PB W/3 NO&N



TE Part # 7-1437569-2
64E2=COLOR PB CAP RED ROUND



TE Part # 7-1437569-3
64E3=COLOR PB CAP ORANGE ROUND



Also in the Series | Alcoswitch Command

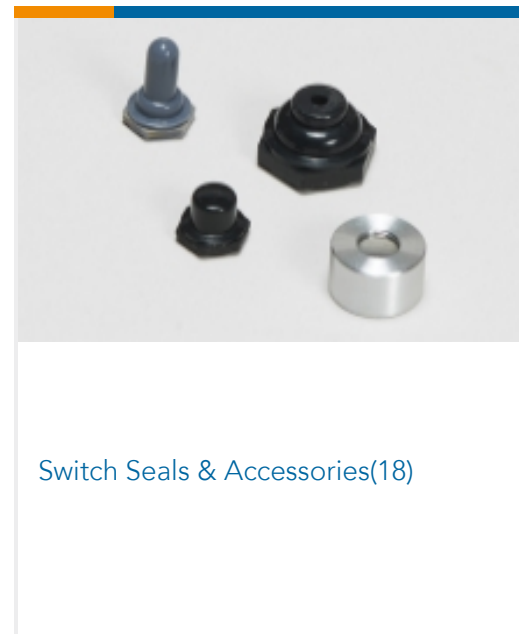
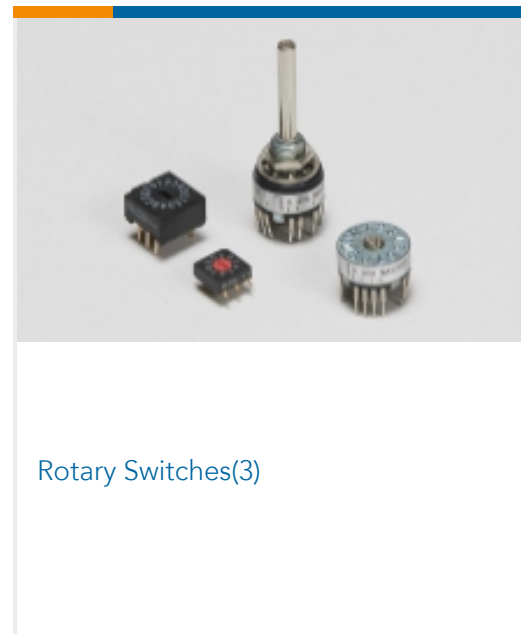
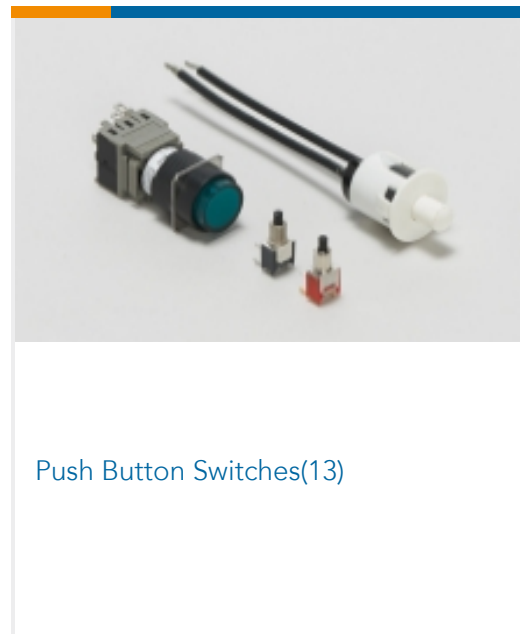
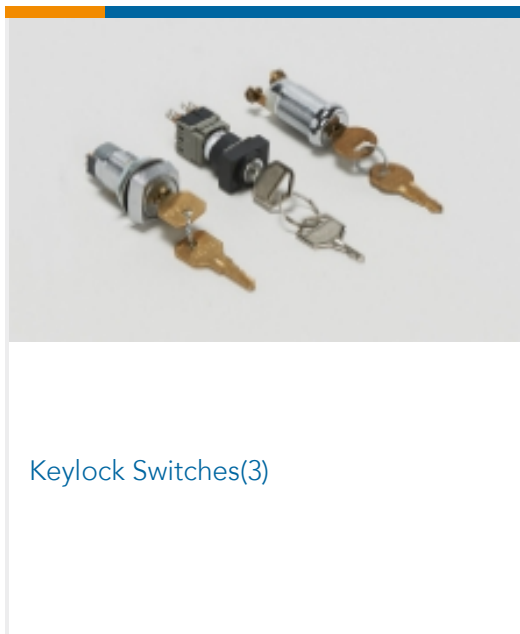

Customers Also Bought

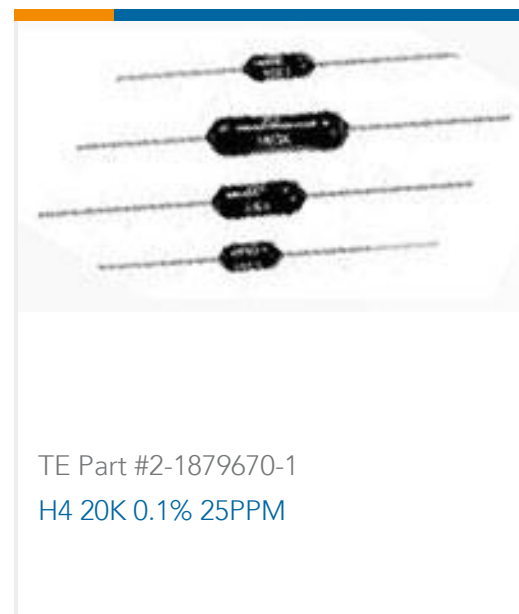
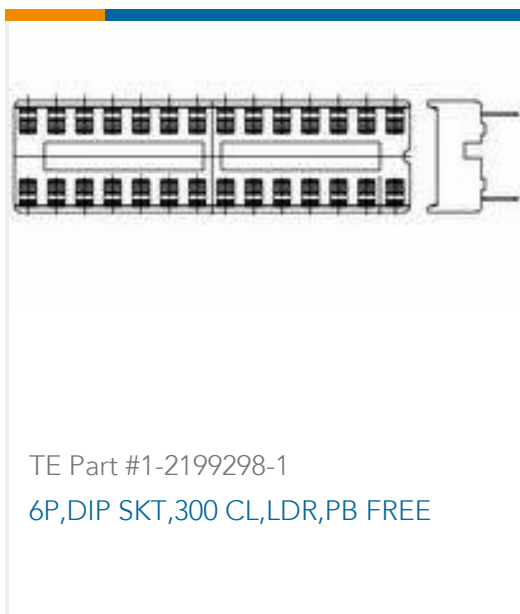
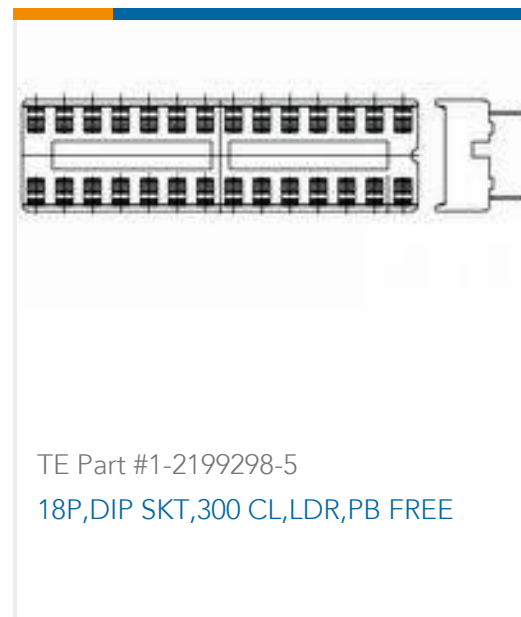



Documents

Product Drawings

[164SL11=SQ MOM ILL PB 1NO&1NC](#)

English

Datasheets & Catalog Pages

[SWITCHES_CORE_PROGRAM_CATALOG](#)

English