

Plastic Hoods with Flat Hood Body
Kunststoffhauben mit flacher Bauweise

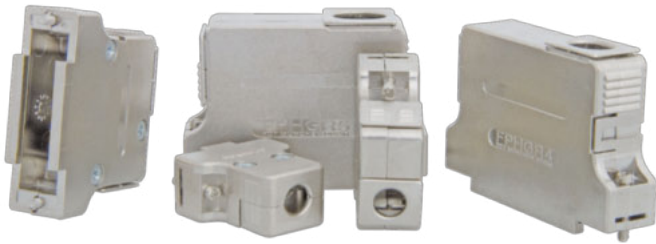

Plastic hoods, series FPHGR, in shell sizes 1 - 5 with cable reduction plates as a special accessory.
Kunststoffhauben der Serie FPHGR in den Gehäusegrößen 1 - 5 mit Kabelreduzierungen als Sonderzubehör.



Shielded plastic hoods, series FPHGR...A, in shell sizes 1 - 5.
Abgeschirmte Kunststoffhauben der Serie FPHGR...A in den Gehäusegrößen 1 - 5.

Right-Angled and Straight Cable Outlets
Rechtwinkliger und gerader Kabelausgang

Advantages and Special Features

- UL recognized File No. E197631
- Flat hood body
- New modified hood due to the omission of the coding frame
- Alternatively straight or / and right angled cable outlet with cable clamp
- Can be used with locking, knurled thumb screws or latch locks
- Also available in shielded (metallised) and / or coded version
- Modification (K189), to enable the use of slide locks, available

Vorteile und Merkmale im Überblick

- UL anerkannt, Eintragsnummer E197631
- flache Bauweise
- neue modifizierte Haube wegen des Wegfalls des Kodierrahmens
- wahlweise gerader oder / und rechtwinkliger Kabelausgang mit Kabelklemme
- verwendbar mit Verriegelungs-, Rändelschrauben oder Rastverriegelung
- auch in abgeschirmter (metallisiert) und / oder codierbarer Version verfügbar
- Modifikation (K189) für den Einsatz von Gleitverriegelung

Dimensions
Abmessungen

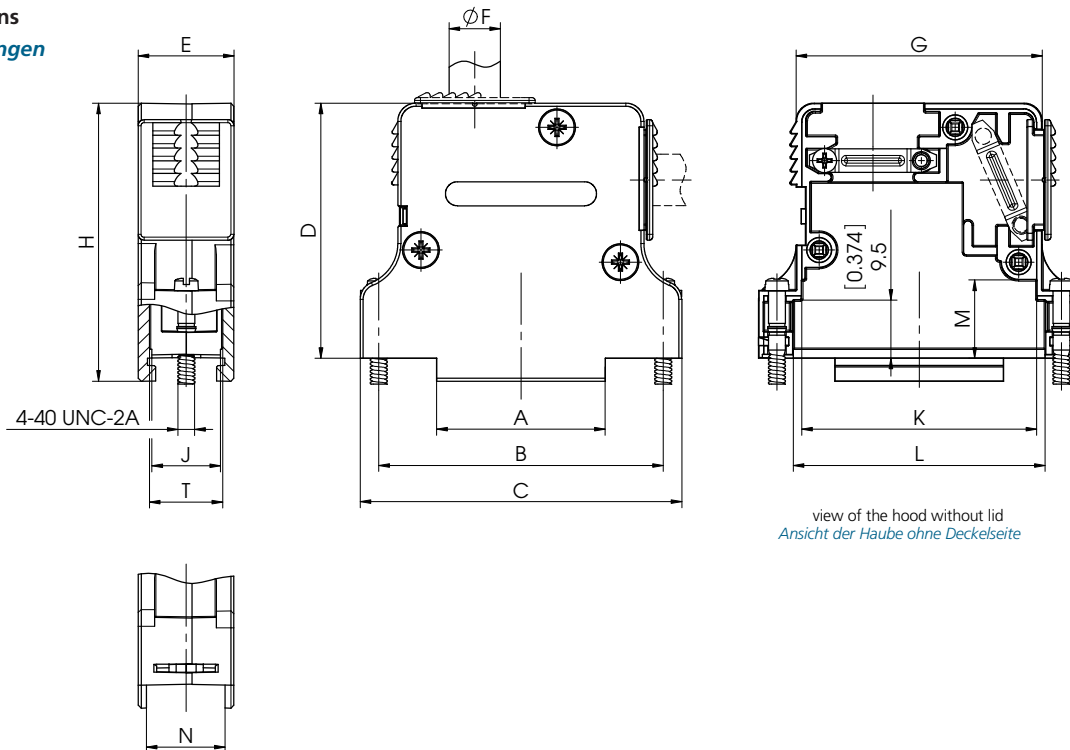

modification no. -K189 only (for side lock system)
nur bei Modifikations-Nr. -K189 (für Gleitverriegelung)



Shell Sizes and Order-Information

Gehäusegrößen und Bestellinformationen

Order- No.	Shell Size / for No. of Contacts	A ±0,3	B ±0,1	C ±0,3	D ±0,3	E ±0,3	øF Cable ø Kabel ø max.	G ±0,3	H ±0,3	J ±0,3	K ±0,3	L ±0,3	M ±0,3	N -0,3	T ±0,3	Cable outlet Kabelausgang
FPHGR-1*	1 / 9	10,0 (0,394)	25,0 (0,984)	31,2 (1,228)	31,8 (1,252)	16,0 (0,630)	7,0 (0,276)	20,0 (0,787)	35,0 (1,378)	11,5 (0,453)	17,0 (0,669)	19,6 (0,772)	15,0 (0,591)	13,0 (0,512)	13,0 (0,512)	0° - -
FPHGR-2*	2 / 15	16,1 (0,634)	33,3 (1,311)	39,2 (1,543)	36,9 (1,453)	16,0 (0,630)	8,0 (0,315)	28,8 (1,134)	40,7 (1,602)	11,4 (0,449)	25,9 (1,020)	27,8 (1,094)	15,0 (0,591)	13,0 (0,512)	12,0 (0,472)	0° - 90°
FPHGR-3*	3 / 25	27,8 (1,094)	47,0 (1,850)	53,3 (2,098)	42,2 (1,661)	16,0 (0,630)	11,2 (0,441)	40,7 (1,602)	46,0 (1,811)	11,4 (0,449)	39,4 (1,551)	41,6 (1,638)	13,0 (0,512)	13,0 (0,512)	12,0 (0,472)	0° rd 60° 90°
FPHGR-4**	4 / 37	44,4 (1,748)	63,5 (2,500)	69,7 (2,744)	42,2 (1,661)	16,0 (0,630)	11,2 (0,441)	57,4 (2,260)	46,0 (1,811)	11,4 (0,449)	54,9 (2,161)	58,0 (2,283)	12,8 (0,504)	13,0 (0,512)	12,0 (0,472)	0° rd 60° 90°
FPHGR-5**	5 / 50	42,0 (1,654)	61,1 (2,406)	67,3 (2,650)	42,2 (1,661)	18,5 (0,728)	14,0 (0,551)	54,2 (2,134)	46,0 (1,811)	14,0 (0,551)	53,2 (2,094)	55,6 (2,189)	13,0 (0,512)	15,8 (0,622)	14,4 (0,567)	0° rd 60° 90°

Dimensions in mm (inch) - *Abmessungen in mm (inch)*

- * For individual packing, please add the suffix **E** to each order no. e.g. **FPHGR-1E**. Standard 100 units per carton.
- ** For individual packing, please add the suffix **E** to each order no. e.g. **FPHGR-4E**. Standard 50 units per carton.

- * *Für einzeln verpackt E anhängen z. B. **FPHGR-1E**. Standard 100 Stück satzweise verpackt.*
- ** *Für einzeln verpackt E anhängen z. B. **FPHGR-4E**. Standard 50 Stück satzweise verpackt.*

Ordering Example:

FPHGR hood, shell size 1 (hood type **FPHGR-1**), shielded version (**A**), for slide lock system (modification **K189**)

Order Number: FPHGR-1A-K189

Bestellbeispiel:

*FPHGR Haube, Gehäusegröße 1 (Haubentyp **FPHGR-1**), abgeschirmte Version (**A**), für Gleitverriegelung (Modifikation **K189**) Bestellnummer: **FPHGR-1A-K189***

Shell Size and Order-Information

For the shielded version, please add the suffix **A** to each hood type.

Gehäusegrößen und Bestell-Informationen

*Für die abgeschirmte Version muss an den Haubentyp der Zusatz **A** angehängt werden.*

**Hood Assembly and Exemplary Demonstration
of Delivery Quantity**
*Haubenaufbau und beispielhafte Darstellung
des Lieferumfangs*

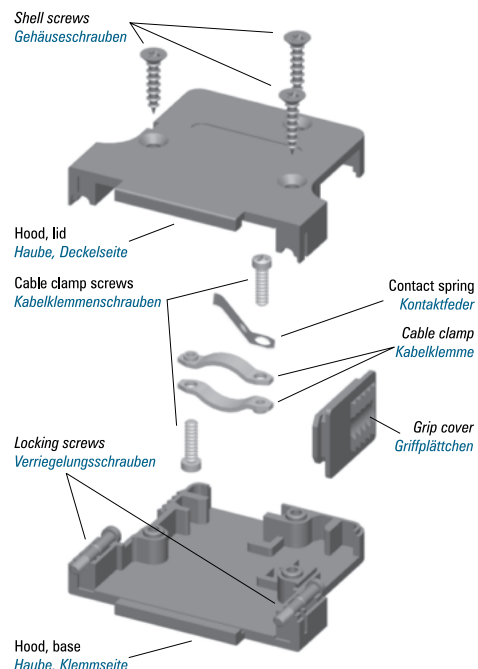

Right-Angled and/or Straight Cable Outlets - Fixed Cable Clamp

Rechtwinkliger und/oder gerader Kabelausgang - Feste Kabelklemme



Metalized hoods, series FPHGR1-5AFR
 Metallisierte Hauben der Baureihe FPHGR1-5AFR



Plastic hoods, series FPHGR1-5FG
 Kunststoffhauben der Baureihe FPHGR1-5FG

Advantages and Special Features

- Flat hood body
- New modified hood due to the omission of the coding frame
- Alternatively straight or / and right angled cable outlet with cable clamp and strain relief (mount stationary)
- Can be used with locking, knurled thumb screws or latch locks
- Also available in shielded (metallised) version
- Modification (K189), to enable the use of slide locks, available

Vorteile und Merkmale im Überblick

- flache Bauweise
- neue modifizierte Haube wegen des Wegfalls des Kodierrahmens
- wahlweise gerader oder / und rechtwinkliger Kabelausgang mit Kabelklemme und Zugentlastung (fest montiert)
- verwendbar mit Verriegelungs-, Rändelschrauben oder Rastverriegelung
- auch in abgeschirmter (metallisiert) Version verfügbar
- Modifikation (K189) für den Einsatz von Gleitverriegelung

Dimensions

Abmessungen

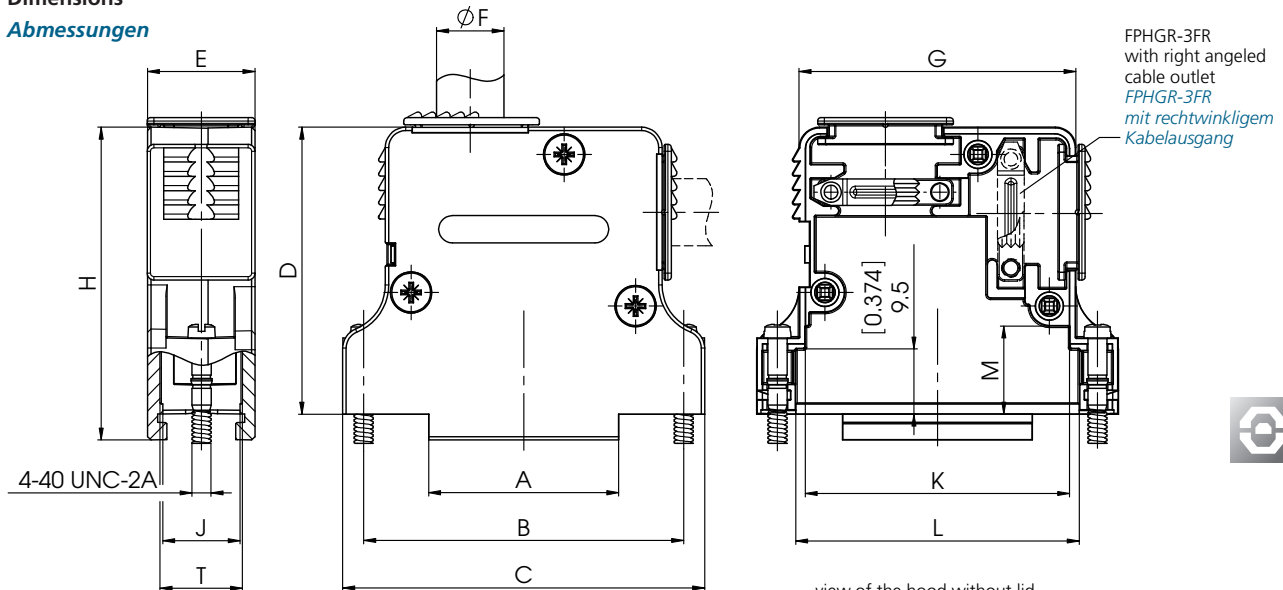

view of the hood without lid
 Ansicht der Haube ohne Deckelseite

modification no. -K189 only (for slide lock system)
 nur bei Modifikation-Nr. K189 (für Gleitverriegelung)



Shell Sizes and Order-Information

Gehäusegrößen und Bestellinformationen

Order- No.	Shell Size / for No. of Contacts	A ±0,3	B ±0,1	C ±0,3	D ±0,3	E ±0,3	øF Cable ø	G ±0,3	H ±0,3	J ±0,3	K ±0,3	L ±0,3	M ±0,3	N -0,3	T ±0,3	Cable outlet
Bestell- nummer	Gehäusegröße / für Polzahl	(±0,012)	(±0,004)	(±0,012)	(±0,012)	(±0,012)	Kabel ø max.	(±0,012)	(±0,012)	(±0,012)	(±0,012)	(±0,012)	(±0,012)	(-0,012)	(±0,012)	Kabel- ausgang
FPHGR-1FG*	1 / 9	10,0 (0,394)	25,0 (0,984)	31,2 (1,228)	31,8 (1,252)	16,0 (0,630)	8,0 (0,315)	20,0 (0,787)	35,0 (1,378)	11,4 (0,449)	16,8 (0,661)	19,4 (0,764)	14,9 (0,587)	13,0 (0,512)	12,8 (0,504)	0°
FPHGR-2FG*	2 / 15	16,1 (0,634)	33,3 (1,311)	39,2 (1,543)	36,9 (1,453)	16,0 (0,630)	8,0 (0,315)	28,8 (1,134)	40,7 (1,602)	11,4 (0,449)	25,9 (1,020)	27,8 (1,094)	15,0 (0,591)	13,0 (0,512)	12,0 (0,472)	0°
FPHGR-3FG*	3 / 25	27,8 (1,094)	47,0 (1,850)	53,3 (2,098)	42,2 (1,661)	16,0 (0,630)	11,2 (0,441)	40,7 (1,602)	46,0 (1,811)	11,4 (0,449)	39,4 (1,551)	41,6 (1,638)	13,0 (0,512)	13,0 (0,512)	12,0 (0,472)	0°
FPHGR-4FG**	4 / 37	44,4 (1,748)	63,5 (2,500)	69,7 (2,744)	42,2 (1,661)	16,0 (0,630)	11,2 (0,441)	57,4 (2,260)	46,0 (1,811)	11,4 (0,449)	54,9 (2,161)	58,0 (2,283)	12,8 (0,504)	13,0 (0,512)	12,0 (0,472)	0°
FPHGR-5FG**	5 / 50	42,0 (1,654)	61,1 (2,406)	67,3 (2,650)	42,2 (1,661)	18,5 (0,728)	14,0 (0,551)	54,2 (2,134)	46,0 (1,811)	14,0 (0,551)	53,2 (2,094)	55,6 (2,189)	13,0 (0,512)	15,8 (0,622)	14,4 (0,567)	0°
FPHGR-2FR*	2 / 15	16,1 (0,634)	33,3 (1,311)	39,2 (1,543)	36,9 (1,453)	16,0 (0,630)	8,0 (0,315)	28,8 (1,134)	40,7 (1,602)	11,4 (0,449)	25,9 (1,020)	27,8 (1,094)	15,0 (0,591)	13,0 (0,512)	12,0 (0,472)	90°
FPHGR-3FR*	3 / 25	27,8 (1,094)	47,0 (1,850)	53,3 (2,098)	42,2 (1,661)	16,0 (0,630)	11,2 (0,441)	40,7 (1,602)	46,0 (1,811)	11,4 (0,449)	39,4 (1,551)	41,6 (1,638)	13,0 (0,512)	13,0 (0,512)	12,0 (0,472)	90°
FPHGR-4FR**	4 / 37	44,4 (1,748)	63,5 (2,500)	69,7 (2,744)	42,2 (1,661)	16,0 (0,630)	11,2 (0,441)	57,4 (2,260)	46,0 (1,811)	11,4 (0,449)	54,9 (2,161)	58,0 (2,283)	12,8 (0,504)	13,0 (0,512)	12,0 (0,472)	90°
FPHGR-5FR**	5 / 50	42,0 (1,654)	61,1 (2,406)	67,3 (2,650)	42,2 (1,661)	18,5 (0,728)	14,0 (0,551)	54,2 (2,134)	46,0 (1,811)	14,0 (0,551)	53,2 (2,094)	55,6 (2,189)	13,0 (0,512)	15,8 (0,622)	14,4 (0,567)	90°

Dimensions in mm (inch) - Abmessungen in mm (inch)

Shell Size and Order-Information

- * For individual packing, please add the suffix **E** to each order no. e.g. **FPHGR-1FGE**. Standard 100 units per carton.
- ** For individual packing, please add the suffix **E** to each order no. e.g. **FPHGR-4FGE**. Standard 50 units per carton.
For the shielded version, please add the suffix **A** to each hood type.

Ordering Example:

FPHGR-...G hood, shell size 1 (hood type **FPHGR-1FG**), shielded version (**A**) Order number: **FPHGR-1AFG** Shielded version (**A**), for slide lock system (modification **K189**)
Order Number: **FPHGR-1AFG-K189**

Gehäusegrößen und Bestell-Informationen

- * für einzeln verpackt **E** anhängen z. B. **FPHGR-1FGE** Standard. 100 Stück satzweise verpackt.
- ** für einzeln verpackt **E** anhängen z. B. **FPHGR-4FGE** Standard 50 Stück satzweise verpackt.
Für die abgeschirmte Version muss an den Haubentyp der Zusatz **A** angehängt werden.

Bestellbeispiel:











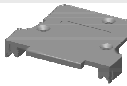
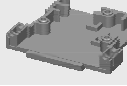

FPHGR-...G Haube, Gehäusegröße 1 (Haubentyp **FPHGR-1FG**), abgeschirmte Version (**A**) Bestellnummer: **FPHGR-1AFG** abgeschirmte Version (**A**), für Gleitverriegelung (Modifikation **K189**) Bestellnummer: **FPHGR-1AFG-K189**

Technical Data

Technische Daten

	FPHGR Standard Plastic Hood FPHGR Kunststoffhaube Standard	FPHGR...A Shielded Plastic Hood FPHGR...A Kunststoffhaube, abgeschirmt
Material and plating	Fibre-glass reinforced polyester, flame retardant according to UL94V-0	ABS, flame-retardant according UL94V-0; plastic with nickel plating over Cu (Partly PC + ABS. More detailed information available on request.)
Material und Oberfläche	Glasfaserverstärkter Polyester, selbstverlöschend entsprechend UL94V-0	ABS, selbstverlöschend entsprechend UL94V-0; metallisiert Ni über Cu (zum Teil PC + ABS, genaue Informationen auf Anfrage)
Temperature range	-55 °C bis 140 °C (-67 °F to 284 °F)	-35 °C bis 95 °C (-31 °F to 203 °F)
Temperaturbereich	-55 °C bis 140 °C	-35 °C bis 95 °C
Max. torque *	40 Ncm (0,295 fl.lb.)	40 Ncm (0,295 fl.lb.)
max. Anzugsmoment *	40 Ncm	40 Ncm
Colour / Plating	Grey	nickel
Farbe / Oberfläche	grau	vernickelt

* Not for locking screws * Nicht für Verriegelungsschrauben

Delivery Quantity <i>Lieferumfang</i>		FPHGR-1	FPHGR-2	FPHGR-3- FPHGR-5	FPHGR-1A	FPHGR-2A	FPHGR-3A- FPHGR-5A	FPHGR-1FG	FPHGR-2FG	FPHGR-3FG- FPHGR-5FR	FPHGR-1AFG	FPHGR-2AFG	FPHGR-3AFG- FPHGR-5AFR
Hood, lid <i>Haube, Deckelseite</i>		1	1	1	1	1	1	1	1	1	1	1	1
Hood, base <i>Haube, Klemmseite</i>		1	1	1	1	1	1	1	1	1	1	1	1
Shell screw <i>Gehäuseschrauben</i>		2	2	3	2	2	3	2	2	3	2	2	3
Locking screw <i>Verriegelungsschraube</i>		2	2	2	2	2	2	2	2	2	2	2	2
Cable clamp <i>Kabelklemme</i>			2	2		2	2						
Cable clamp <i>Kabelklemme</i>		1			1								
Cable clamp <i>Kabelklemme</i>								1	1	1	1	1	1
Cable clamp screw <i>Kabelklemmschraube</i>		2	2	2	2	2	2						
Cable clamp screw <i>Kabelklemmschraube</i>								2	2	2	2	2	2
Grip cover <i>Griffplättchen</i>			1	1		1	1		1	1		1	1
Cable reduction plate <i>Kabeldurchgangreduzierung</i>						1	1	1	1	1	1	1	1
Contact spring <i>Kontaktfeder</i>						1	1						
Strain relief <i>Zugentlastung</i>								1	1	1	1	1	1

Hood Assembly and Exemplary Demonstration of Delivery Quantity
Haubenaufbau und beispielhafte Darstellung des Lieferumfangs

