

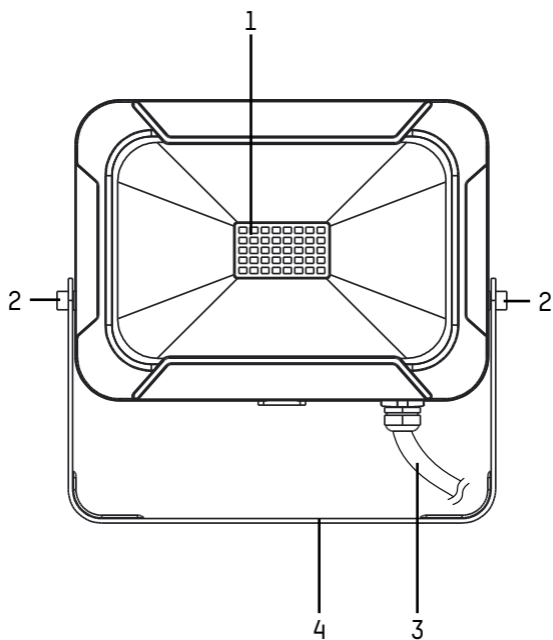

1600-0280: WFL800
1600-0281: WFL1600
1600-0282: WFL2400

WANDSTRAHLER WALL-FLOODLIGHT

BEDIENUNGSANLEITUNG MANUAL



ORIGINALBETRIEBSANLEITUNG

WANDSTRAHLER

WFL800 | WFL1600 | WFL2400

INHALTSVERZEICHNIS

Lieferumfang	3
Zeichenerklärung	4
Bestimmungsgemäßer Gebrauch	4
Sicherheitshinweise	4
Produktbeschreibung	6
Montage	6
Anschluss	8
Scheinwerfer einstellen	9
Reinigung	9
Technische Daten	10
Entsorgung	11
HAFTUNGSAUSSCHLÜSSE	11
GARANTIEHINWEIS	11

LIEFERUMFANG

1x Wandstrahler

1x Bedienungsanleitung

Packen Sie zunächst das Produkt aus und überprüfen Sie es auf Vollständigkeit und Beschädigungen. Nehmen Sie ein beschädigtes Produkt nicht in Betrieb. Sollten Sie Beschädigungen am Produkt feststellen, kontaktieren Sie Ihren Händler.

ZEICHENERKLÄRUNG

Bitte beachten Sie folgende Zeichen und Wörter, welche Sie in der Bedienungsanleitung, auf dem Produkt und auf der Verpackung verwendet werden.

 = Information

Nützliche Zusatz-Informationen zum Produkt

 = Hinweis

Dieser Hinweis warnt vor möglichen Schäden aller Art



 = **Warnung**

Achtung – Gefährdung! Kann zu schweren Verletzungen oder zum Tod führen

 = Schutzklasse I

 = Stromschlaggefahr

 = Nicht in den Lichtstrahl schauen

 →  = Bei Glasbruch nicht betreiben

BESTIMMUNGSGEMÄSSER GEBRAUCH

Das Produkt dient der Beleuchtung von Einfahrten, Durchgängen, Freiflächen, usw.

Das Produkt ist ausschließlich für den privaten Gebrauch im Haushalt und nicht für den kommerziellen Gebrauch bestimmt.

SICHERHEITSHINWEISE



Lesen Sie vor Inbetriebnahme des Produkts die komplette Bedienungsanleitung sorgfältig durch. Sie enthält wichtige Hinweise zum Umgang mit dem Produkt.

Wenn Sie das Produkt an dritte Personen weiterreichen, händigen Sie diese Bedienungsanleitung mit aus.

- Halten Sie Kinder vom Produkt und der Verpackung fern. Das Produkt ist kein Spielzeug. Kinder sollten beaufsichtigt werden, um sicherzustellen, dass sie nicht mit dem Produkt spielen.

- **Lebensgefahr durch Stromschlag!** Vergewissern Sie sich stets, dass die Stromzufuhr vor der Montage oder anderen Tätigkeiten am Produkt unterbrochen ist. Sichern Sie den Schaltkasten gegen Wiedereinschalten durch Dritte, z. B. mit einem Warnschild.
- Prüfen Sie immer, ob die Netzspannung mit den Angaben auf dem Typenschild des Produkts übereinstimmt, bevor Sie das Produkt anschließen.
- Der Befestigungsuntergrund und die Befestigungsmaterialien müssen das Produkt sicher halten können. Im Zweifel wenden Sie sich an eine fachkundige Person.
- **Lebensgefahr durch Stromschlag!** Achten Sie darauf, während der Bohrung der Löcher keine Wasser-, Strom- oder Telefonleitungen zu beschädigen. Verwenden Sie ein Leitungssuchgerät.
- Dieses Produkt entspricht der Schutzart IP54: Geschützt gegen das Eindringen von Staub zu gefährlichen und sensiblen Teilen. Spritzwassergeschützt. Produkt nicht in Wasser tauchen. Die IP-Schutzart ist nur bei ordnungsgemäß montiertem Produkt gewährleistet.
- Fassen Sie das Produkt nicht mit nassen oder feuchten Händen an.
- Achten Sie darauf, dass das Anschlusskabel nicht gespannt ist oder in Kontakt mit scharfen Gegenständen, Chemikalien oder Lösungsmitteln gerät.
- Überprüfen Sie regelmäßig die Anschlussleitung und den Netzstecker auf Beschädigungen.
- Zur Vermeidung von Gefährdungen darf eine beschädigte äußere flexible Leitung dieser Leuchte ausschließlich vom Hersteller, seinem Servicevertreter oder einer vergleichbaren Fachkraft ausgetauscht werden.



Das Produkt entspricht der Schutzklasse I und muss somit an den Schutzleiter angeschlossen werden.



Lebensgefahr durch Stromschlag! Die unsachgemäße Verwendung, Bedienung oder Montage birgt das Risiko eines lebensgefährlichen Stromschlags. Das Produkt darf ausschließlich durch eine Elektrofachkraft angeschlossen werden!



Schauen Sie nicht direkt in den Lichtstrahl.

Leuchten Sie nicht anderen Personen ins Gesicht. Geschieht dies zu lange, kann durch Blaulichtanteile eine Netzhautgefährdung auftreten.



Das Sicherheitsglas ist nicht austauschbar. Bei beschädigtem Sicherheitsglas muss das Produkt entsorgt werden.

- Ein gefahrloser Betrieb ist nicht mehr möglich, wenn das Produkt sichtbare Beschädigungen aufweist. Wenn das Produkt beschädigt ist, muss es entsorgt oder repariert werden.
- Reparieren Sie das Produkt nicht selbst! Lassen Sie Reparaturen nur von einer Elektrofachkraft durchführen.
- Die Lichtquelle dieser Leuchte ist nicht austauschbar. Wenn die Lebensdauer der Lichtquelle endet, muss die gesamte Leuchte ersetzt werden.
- **Achtung!** Zum Anschluss darf nur ein Anschlusskabel der Kategorie H05RN-F 3G 1 mm² oder höherwertig verwendet werden.

i PRODUKTBESCHREIBUNG

(siehe Seite 2)

- | | |
|----------------------|-----------------------|
| 1 LEDs | 3 Anschlussleitung |
| 2 Feststellschrauben | 4 Halte-/Montagebügel |

i MONTAGE

- Unterbrechen Sie die Stromversorgung zum Kabel direkt am Schaltkasten und sichern Sie diesen gegen Wiedereinschalten durch Dritte.
- Wählen Sie eine geeignete Montageposition für das Produkt.

Hinweise:

Die Befestigungslöcher im Bügel besitzen einen Durchmesser von 5 mm. Wählen Sie passendes Montagematerial aus.

Die Montagematerialien sind nicht mitgeliefert. Als Beispiel wird in dieser Anleitung die Montage mit 2 Schrauben und 2 Dübeln gezeigt. Je nach Bedarf können Sie andere Montagematerialien verwenden.



1.

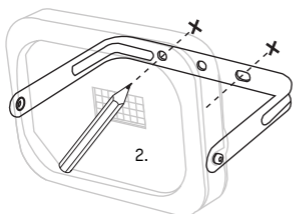

2.

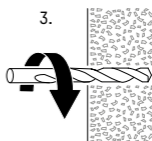

3.

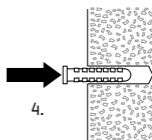

4.

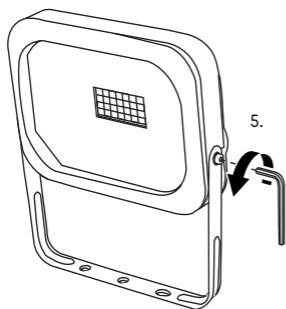

5.

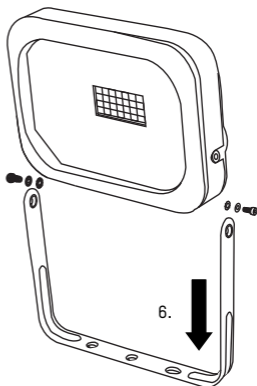

6.

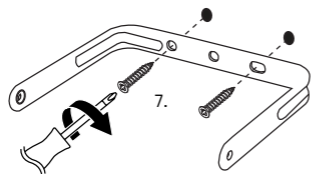

7.

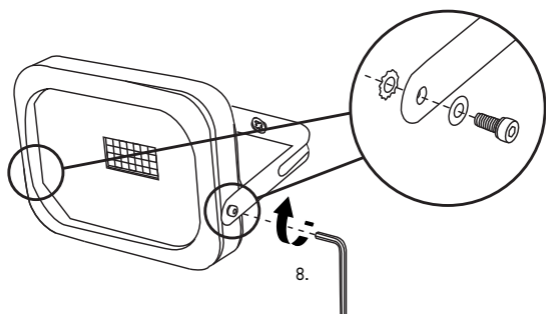

ANSCHLUSS

- Schließen Sie die Adern entsprechend den Markierungen an:

L Phase (braun)

 Erdung (gelb-grün)

N Neutral (blau)

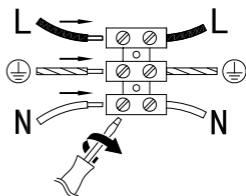

- Stellen Sie die Spannungsversorgung wieder her.

i SCHEINWERFER EINSTELLEN

- Lösen Sie die Feststellschrauben.

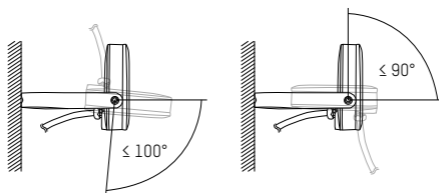

- Stellen Sie den gewünschten Winkel des Scheinwerfers ein (-100° bis +90°).

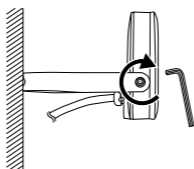

- Ziehen Sie die Feststellschrauben mit einem Innensechskantschlüssel fest.

i REINIGUNG

- Unterbrechen Sie vor jeder Reinigung die Spannungsversorgung zum Produkt direkt am Schaltkasten. Sichern Sie das Produkt vor unbeabsichtigtem Wiedereinschalten, indem Sie ein Hinweisschild am Schaltkasten positionieren.
- Zur Reinigung verwenden Sie lediglich ein weiches, trockenes oder leicht feuchtes Tuch (gegebenenfalls unter Zugabe von etwas mildem Geschirrspülmittel). Verwenden Sie zur Reinigung auf keinen Fall Scheuer- oder Lösungsmittel.

TECHNISCHE DATEN

Modell	1600-0280: WFL800	1600-0281: WFL1600	1600-0282: WFL2400
Anschlussspannung	220-240 V~, 50/60 Hz		
Leistung in Watt	10 W	20 W	30 W
IP-Schutzart	IP54 (spritzwassergeschützt)		
Schutzklasse	I		
Leuchtmitteltyp	LED		
Farbtemperatur	5000 K		
Nennlichtstrom	900 lm	1800 lm	2700 lm
Maximale Projektionsfläche	200 cm ²	385 cm ²	470 cm ²
Montageort	Innen und außen		
Montagehöhe	max. 3 m		
Betriebstemperatur t _a	-20 bis +50 °C		
Abmessungen Glas (B x H x T) – ca.	124 x	177 x	201 x
	90 x	127 x	146 x
	4 mm	4 mm	4 mm
Abmessungen mit Bügel (B x H x T) – ca.	147 x	202 x	231 x
	136 x	190 x	202 x
	42 mm	34 mm	41 mm
Gewicht	0,44 kg	0,82 kg	1,15 kg

ENTSORGUNG



Entsorgen Sie die unbrauchbare Leuchte gemäß den gesetzlichen Bestimmungen. Die Kennzeichnung „Mülltonne“ weist darauf hin, dass Elektrogeräte in der EU nicht mit dem normalen Haushaltsmüll entsorgt werden dürfen. Benutzen

Sie die Rückgabe- und Sammelsysteme in Ihrer Gemeinde oder wenden Sie sich an den Händler, bei dem das Produkt gekauft wurde.

Damit erfüllen Sie Ihre gesetzlichen Pflichten und leisten Ihren Beitrag zum Umweltschutz.

HAFTUNGSAUSSCHLÜSSE

Die in dieser Bedienungsanleitung enthaltenen Informationen können ohne Vorankündigung geändert werden. ANSMANN übernimmt keine Haftung für direkte, indirekte, zufällige oder sonstige Schäden oder Folgeschäden, die durch unsachgemäße Handhabung oder durch Missachtung der in dieser Bedienungsanleitung enthaltenen Informationen entstehen. Bei falscher Verwendung des Produktes übernehmen wir keine Haftung und gewähren keine Gewährleistungs- oder Garantieansprüche.

GARANTIEHINWEIS

Auf das Produkt bieten wir eine zehnjährige Garantie. Bei Schäden am Produkt, die infolge Nichtbeachtung der Bedienungsanleitung entstehen, kann keine Garantie gewährt werden.

Ihr gesetzlicher Gewährleistungsanspruch wird hierdurch nicht beeinträchtigt.

Unsere Garantiebestimmungen finden Sie online unter www.ansmann.de



www.tuv.com
ID 141908831



1600-0280
1600-0281

 Das Produkt entspricht den Anforderungen der EU-Richtlinien.



www.tuv.com
ID 141908822



1600-0282

TRANSLATION OF THE ORIGINAL INSTRUCTIONS

WALL FLOODLIGHT

WFL800 | WFL1600 | WFL2400

CONTENTS

Scope of delivery.....	12
Signs and symbols.....	13
Intended use	13
Safety instructions	13
Product description	15
Installation	15
Connection.....	17
Setting the floodlight	18
Cleaning.....	18
Technical data.....	19
Disposal.....	20
DISCLAIMERS	20
WARRANTY INFORMATION	20

SCOPE OF DELIVERY

1x Wall floodlight

1x Instruction manual

First unpack the product and check it for completeness and damages. Do not operate the product if it is damaged. Contact your retailer should you find any damage to the product.

SIGNS AND SYMBOLS

Please adhere to the following signs and warnings used in the instruction manual, on the product and on the packaging.

 = Information

Additional useful information about the product

 = Notice

This notice informs the user of possible damages of all kinds



 = Warning

Caution – Danger! Can result in serious injury or death

 = Protection class I

 = Risk of electric shock

 = Do not look into the light beam

 →  = Do not operate if glass is broken

 INTENDED USE

The product serves to illuminate driveways, passageways, open spaces, etc.

The product is designed exclusively for household use; it is not suitable for commercial purposes.

 SAFETY INSTRUCTIONS



Carefully read the entire instruction manual before first operating the product. It contains important information on handling the product.

If you give the product to third parties, you must include this instruction manual.

- Keep children away from the product and the packaging. The product is not a toy. Children should be supervised to ensure that they do not play with the product.
- Risk of fatal injury due to electric shock! Always make sure that you interrupt the power supply before installation or other product-related actions. Protect the fuse box against unauthorized activation by third parties, e.g. with a warning sign.

- Before connecting the product with the power supply, always make sure that the supply voltage complies with the information on the rating plate.
- The mounting surface and materials must be able to securely hold the product. In case of doubt, consult an expert.
- Risk of fatal injury due to electric shock! Take care not to damage water, electricity or telecommunications lines while drilling holes. Use a cable locator.
- This product complies with protection class IP54: Protected against the ingress of dust into hazardous and sensitive components. Splash-proof. Do not immerse the product in water. The IP protection class is only ensured when the product is correctly installed.
- Never touch the product with wet or damp hands.
- Always ensure that the power cord is not taut nor comes into contact with sharp objects, chemicals or solvents.
- Regularly check the power cord and power plug for damages.
- To avoid hazards, the flexible exterior cord of this floodlight, if damaged, may only be replaced by the manufacturer, its service representative or a comparable professional.



This product complies with protection class I and must therefore be connected to the protective earth conductor.



Risk of fatal injury due to electric shock! Improper use, operation or installation poses a risk of potentially fatal electric shock. The product may be connected by a professional electrician only!



Do not look directly into the beam of light.

Do not shine the light in the faces of others. Looking into the beam of light for too long may cause damage to the retina due to blue light.



The safety glass is non-replaceable. If the safety glass is damaged, dispose of the product.

- Safe operation cannot be guaranteed if the product shows any kind of damage. If the product is damaged, it must be disposed of or repaired.

- Do not repair the product yourself! Have repairs carried out by a professional electrician.
- The luminary is non-replaceable. The entire product must be replaced when the luminary reaches the end of its service life.
- Caution! Use a H05RN-F 3G 1 mm² or higher category connection cable for connection only.

PRODUCT DESCRIPTION

(see page 2)

- | | |
|--------------|--------------------|
| 1 LEDs | 3 Power cord |
| 2 Set screws | 4 Mounting bracket |

INSTALLATION

- Interrupt the power supply to the cable at the fuse box and secure it against reconnection by third parties.
- Select a suitable location for product installation.

Please note:

The mounting holes in the bracket have a diameter of 5 mm. Select suitable mounting materials.

Mounting materials are not included. This manual shows by way of example installation using 2 screws and 2 wall anchors. If necessary, you can use other mounting materials.

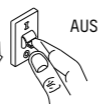

1.

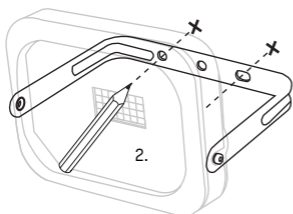

2.

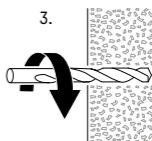

3.

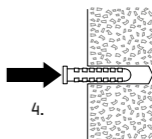

4.

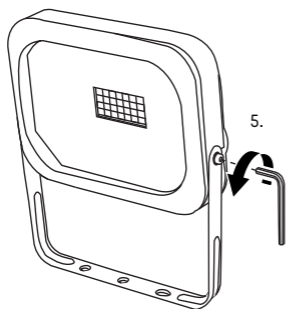

5.

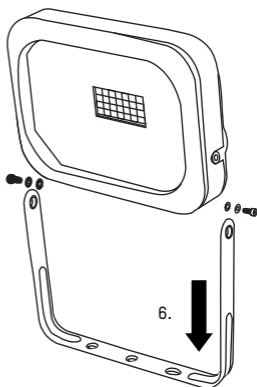

6.

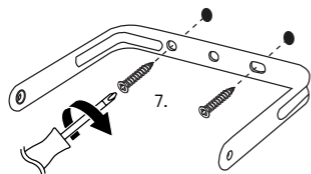

7.

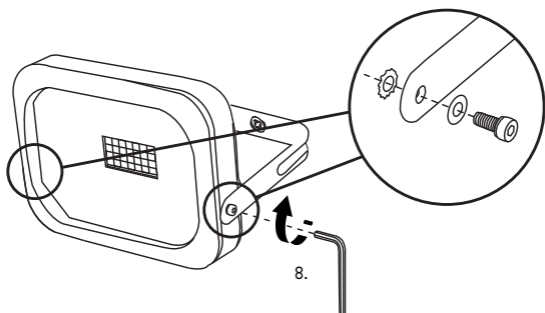

CONNECTION

- Connect the wires according to the markings:

L	Phase	(brown)
	Grounding	(yellow-green)
N	Neutral	(blue)

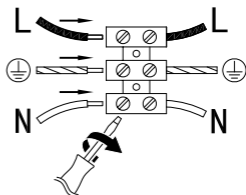

- Turn back on the power supply.

i SETTING THE FLOODLIGHT

- Loosen the set screws.

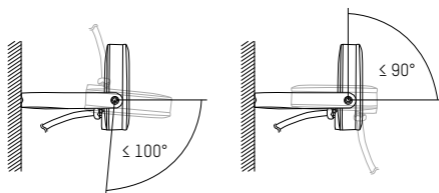

- Set the desired angle of the floodlight (-100° to +90°).

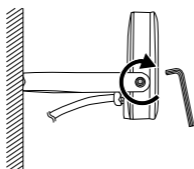

- Tighten the set screws with a hex key.

i CLEANING

- Always disconnect the power supply at the fuse box before cleaning the product. Secure the product against unintended reactivation by placing a warning sign on the fuse box.
- Use only a soft, dry or slightly damp cloth (where necessary with a little mild dishwashing detergent) to clean the product. Never use any abrasive cleaners or solvents to clean the product.

TECHNICAL DATA

Model	1600-0280: WFL800	1600-0281: WFL1600	1600-0282: WFL2400
Supply voltage	220-240 V~, 50/60 Hz		
Power output in watts	10 W	20 W	30 W
IP protection class	IP54 (splashproof)		
Protection class	I		
Luminary type	LED		
Colour temperature	5000 K		
Nominal luminous flux	900 lm	1800 lm	2700 lm
Max. projection area	200 cm ²	385 cm ²	470 cm ²
Installation site	Indoors and outdoors		
Installation height	max. 3 m		
Operating temperature t _a	-20 to +50 °C		
Glass dimensions (W x H x D) – approx.	124 x	177 x	201 x
	90 x	127 x	146 x
	4 mm	4 mm	4 mm
Dimensions with bracket (W x H x D) – approx.	147 x	202 x	231 x
	136 x	190 x	202 x
	42 mm	34 mm	41 mm
Weight	0.44 kg	0.82 kg	1.15 kg

DISPOSAL



At the end of its service life, dispose of the light in keeping with all legal requirements. The dustbin symbol indicates that waste electrical and electronic equipment may not be disposed of with normal household waste within the EU. Please use local recycling and collection points or contact the retailer where you purchased the product.

You thus fulfill your statutory obligations and contribute to protection of the environment.

DISCLAIMERS

The information contained in this instruction manual is subject to change without prior notice. ANSMANN assumes no liability for direct, indirect, accidental or other types of damage or consequential damage that result from improper handling of the product or failure to comply with the information contained in this instruction manual. We assume no liability and grant no warranty claims in cases of improper use of the product.

WARRANTY INFORMATION

We offer a ten-year warranty on the product. Damages to the product due to failure to observe the instruction manual will void the warranty. This does not affect your legal warranty right.

You can find our warranty terms online at www.ansmann.de



www.tuv.com
ID 141906831



1600-0280
1600-0281



The product meets the conditions of the European Union.



www.tuv.com
ID 141906822



1600-0282

TRADUCTION DE LA NOTICE ORIGINALE

SPOT MURAL

WFL800 | WFL1600 | WFL2400

TABLE DES MATIÈRES

Contenu de l'emballage.....	21
Légende des symboles.....	22
Utilisation prévue.....	22
Consignes de sécurité.....	22
Description du produit.....	24
Montage.....	24
Raccordement.....	26
Réglage de l'éclairage.....	27
Nettoyage.....	27
Données techniques.....	28
Mise au rebut/recyclage.....	29
CLAUSES DE NON-RESPONSABILITÉ.....	29
INFORMATION CONCERNANT LA GARANTIE.....	29

CONTENU DE L'EMBALLAGE

- 1 Spot mural
- 1 Mode d'emploi

Déballez d'abord le produit puis vérifiez l'exhaustivité de l'emballage et si des dommages sont présents. N'utilisez pas un produit endommagé ! Si vous deviez constater des dégâts sur le produit, prenez contact avec votre commerçant.

LÉGENDE DES SYMBOLES

Veillez consulter les symboles et mentions suivants qui sont utilisés dans le mode d'emploi, présents sur le produit et l'emballage.

 = Information

Informations supplémentaires utiles concernant le produit.

 = Remarque

Cette remarque met en garde contre différentes possibilités de dommages.

 = Avertissement

Attention - danger ! Peut entraîner des blessures graves voire mortelles.

 = Classe de protection I

 = Risque d'électrocution

 = Ne pas regarder le faisceau lumineux !

 = Ne pas faire fonctionner si le verre est cassé !

UTILISATION PRÉVUE

Le produit sert à l'éclairage d'entrées, de passages, d'espaces libres, etc.

Le produit est exclusivement réservé à une utilisation domestique et ne convient pas pour un usage commercial.

CONSIGNES DE SÉCURITÉ



Avant d'utiliser le produit, lisez attentivement et complètement le mode d'emploi. Il contient des instructions importantes sur l'utilisation du produit.

Si vous donnez le produit à un tiers, transmettez-le absolument avec ce mode d'emploi.

- Tenez les matériaux d'emballage et le produit hors de la portée des enfants ! Ce produit n'est pas un jouet. Les enfants doivent être surveillés afin de s'assurer qu'ils ne jouent pas avec le produit.
- Risque de blessures mortelles en cas d'électrocution ! Assurez-vous toujours que l'alimentation électrique soit coupée avant d'effectuer le montage ou toute autre opération sur le produit. Sécurisez le coffret de commande contre la remise en service intempestive par un tiers, par ex. avec un panneau d'avertissement.

- Avant de brancher le produit, vérifiez toujours que la tension de réseau corresponde bien aux spécifications de son étiquette signalétique.
- La surface de montage et les matériaux de montage doivent pouvoir supporter le produit en toute sécurité. En cas de doute, contactez une personne compétente.
- Risque de blessures mortelles en cas d'électrocution ! Lors du perçage de trous, veillez à ne pas endommager de lignes téléphoniques, de canalisations d'eau ou de câbles électriques. Utilisez un localisateur de lignes électriques.
- Ce produit correspond à l'indice de protection IP54 : protégé contre la pénétration de poussière dans les parties dangereuses et sensibles. Étanche aux projections d'eau. Ne plongez pas le produit dans l'eau ! Le degré de protection IP n'est garanti que si le produit est correctement monté.
- Ne saisissez pas le produit avec les mains mouillées ou humides.
- Veillez à ce que le cordon d'alimentation en électricité ne soit pas tendu et qu'il n'entre pas en contact avec des objets coupants, des produits chimiques ou des solvants.
- Vérifiez régulièrement la fiche de secteur et le cordon d'alimentation afin de détecter des dommages !
- Pour éviter tout danger, si la matière externe souple du fil électrique de cet éclairage est endommagée, il ne doit être remplacé que par le fabricant, son service technique agréé ou un technicien spécialisé.



Ce produit correspond à la classe de protection I et doit donc être branché à un conducteur de protection (relié à la terre).



Risque de blessures mortelles en cas d'électrocution !
L'utilisation inappropriée, le fonctionnement et/ou le montage incorrects risquent de provoquer un choc électrique mettant en danger votre vie. Le produit doit être raccordé uniquement par un service technique spécialisé en électricité !



Ne regardez pas directement dans le faisceau lumineux !
N'éclairez pas le visage d'autres personnes. Si cela se produit trop longtemps, des composants de lumière bleue risquent de provoquer des dommages à la rétine.



Le verre de sécurité n'est pas remplaçable. Si le verre de sécurité est endommagé, le produit doit être mis au rebut.

- Une utilisation sans danger n'est plus possible si le produit est visiblement endommagé. Si le produit est endommagé, il doit être mis au rebut ou réparé.
- Ne réparez pas le produit vous-même ! Laissez seulement un service technique spécialisé en électricité effectuer les réparations.
- La source d'éclairage de cette lampe n'est pas remplaçable. Si la durée de vie de la source d'éclairage est terminée, le projecteur dans son ensemble doit être remplacé.
- Attention ! Vous ne pouvez utiliser qu'un câble de raccordement de la catégorie H05RN-F 3G 1 mm² ou de meilleure qualité pour le branchement.

i DESCRIPTION DU PRODUIT

(voir page 2)

- | | |
|------------------|-----------------------------|
| 1 LED | 3 Cordon d'alimentation |
| 2 Vis de blocage | 4 Étrier de retenue/montage |

i MONTAGE

- Coupez l'alimentation électrique du câble directement au coffret de commande et protégez la coupure contre toute remise en service intempestive par un tiers.
- Choisissez un emplacement de montage approprié au produit !

Remarques :

les trous de fixation de l'étrier ont un diamètre de 5 mm, par conséquent, choisissez les matériaux de montage qui conviennent ;

les matériaux de montage ne sont pas fournis ; le montage avec 2 vis et 2 chevilles est donné comme exemple dans ce mode d'emploi, mais selon vos besoins, vous pouvez utiliser d'autres matériaux de montage.

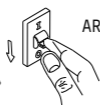

ARRÊT

1.

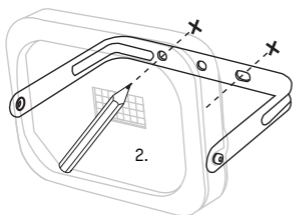

2.

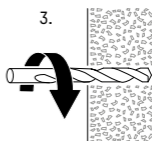

3.

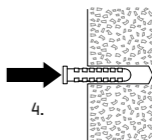

4.

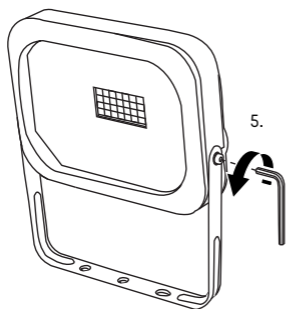

5.

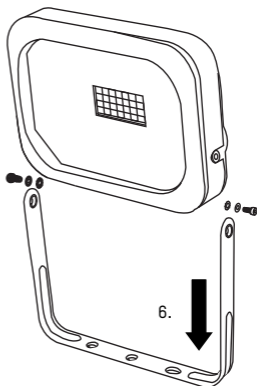

6.

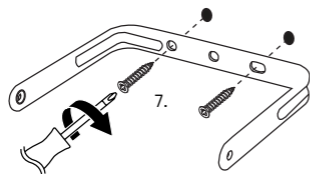

7.

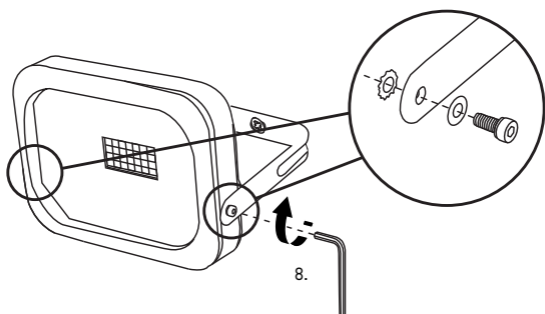

RACCORDEMENT

- Branchez les fils conformément aux repères :

L Phase (marron)

 Mise à la terre (jaune+vert)

N Neutre (bleu)

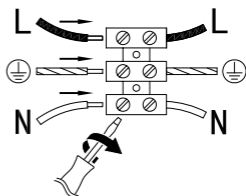

- Remettez l'alimentation électrique.

i RÉGLAGE DE L'ÉCLAIRAGE

- Desserrez les vis de blocage.

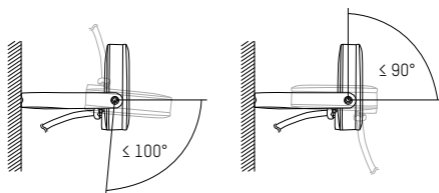

- Ajustez l'angle d'éclairage du spot désiré (- 100° à + 90°).

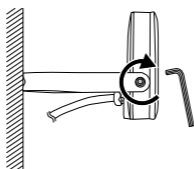

- Resserrez les vis de blocage avec une clé mâle pour vis à six pans.

i NETTOYAGE

- Coupez l'alimentation en courant à partir du coffret de commande avant chaque nettoyage du produit. Sécurisez le produit contre toute remise en service intempestive par un tiers, en plaçant par ex. un panneau d'avertissement sur le coffret de commande.
- Pour le nettoyage, utilisez uniquement un chiffon doux, sec ou légèrement humide (avec éventuellement un produit à vaisselle doux). Lors du nettoyage, n'utilisez en aucun cas de produits récurants ou des solvants.

DONNÉES TECHNIQUES

Modèle	1600-0280 : WFL800	1600-0281 : WFL1600	1600-0282 : WFL2400
Tension de raccordement	220-240 V~, 50/60 Hz		
Puissance en watt	10 W	20 W	30 W
Indice de protection IP	IP54 (protégé contre les projections d'eau)		
Classe de protection	I		
Type d'éclairage	LED		
Température de la couleur	5000 K		
Flux lumineux nominal	900 lm	1800 lm	2700 lm
Surface maximale de projection	200 cm ²	385 cm ²	470 cm ²
Emplacement de montage	intérieur et extérieur		
Hauteur de montage	3 m maxi		
Température de fonctionnement t _a	de - 20 à + 50 °C		
Dimensions du verre (l x H x P) - env.	124 x	177 x	201 x
	90 x	127 x	146 x
	4 mm	4 mm	4 mm
Dimensions avec étrier (l x H x P) - env.	147 x	202 x	231 x
	136 x	190 x	202 x
	42 mm	34 mm	41 mm
Poids	0,44 kg	0,82 kg	1,15 kg

i MISE AU REBUT/RECYCLAGE



Recyclez l'éclairage inutilisable conformément aux dispositions légales. Le sigle d'identification « poubelle » indique que les appareils électriques ne doivent pas être jetés dans les ordures ménagères dans l'UE. Veuillez utiliser les systèmes de retour et de collecte de votre municipalité ou contacter le détaillant où le produit a été acheté.

Vous respectez ainsi les ordonnances légales et contribuez à la protection de l'environnement.

i CLAUSES DE NON-RESPONSABILITÉ

Les informations contenues dans ce mode d'emploi peuvent être modifiées sans préavis. ANSMANN décline toute responsabilité pour les dommages directs, indirects, accidentels ou autres, ou les dégâts consécutifs résultant d'une mauvaise manipulation ou du non-respect des instructions contenues dans ce mode d'emploi. Si le produit est utilisé de manière incorrecte, nous déclinons toute responsabilité et n'accordons aucun recours ou aucune garantie.

i INFORMATION CONCERNANT LA GARANTIE

Nous offrons une garantie de 10 ans sur le produit. Aucune garantie ne peut être accordée si des dommages sur le produit résultent du non-respect du mode d'emploi.

Votre demande de garantie légale n'est pas affectée ici.

Vous trouverez nos conditions de garantie en ligne à l'adresse www.ansmann.de



Le produit est conforme aux exigences des directives européennes.



www.tuv.com
ID 141906831



1600-0280
1600-0281



www.tuv.com
ID 141906822



1600-0282

TRADUCCIÓN DEL MANUAL ORIGINAL

REFLECTOR DE PARED

WFL800 | WFL1600 | WFL2400

ÍNDICE DE CONTENIDO

Volumen de suministro.....	30
Explicación de los signos.....	31
Uso conforme a lo previsto.....	31
Indicaciones de seguridad.....	31
Descripción del producto.....	33
Montaje.....	33
Conexión.....	35
Ajuste del faro.....	36
Limpieza.....	36
Datos técnicos.....	37
Eliminación.....	38
LIMITACIONES DE RESPONSABILIDAD.....	38
INFORMACIÓN SOBRE LA GARANTÍA.....	38

VOLUMEN DE SUMINISTRO

- 1x Reflector de pared
- 1x Manual de instrucciones

Desembale primero el producto y compruebe que esté completo y no presente daños. No ponga en marcha un producto dañado. Si detecta daños en el producto, póngase en contacto con su distribuidor.

EXPLICACIÓN DE LOS SIGNOS

Tenga en cuenta los siguientes signos y palabras que se emplean en el producto y en el embalaje.

 = Información

Información adicional útil sobre el producto

 = Nota

Esta nota advierte de cualquier daño posible



 = Advertencia

¡Atención – Peligro! Puede provocar lesiones graves e incluso la muerte

 = Clase de protección I

 = Peligro de descarga eléctrica

 = No mirar directamente al haz luminoso

 →  = No utilizar si se rompe el cristal

USO CONFORME A LO PREVISTO

El producto sirve para iluminar las entradas, pasos, espacios abiertos etc.

El producto solo es apropiado para el uso privado y no para el uso comercial.

INDICACIONES DE SEGURIDAD



Lea atentamente el manual de instrucciones antes de utilizar el producto. Este contiene información importante sobre el manejo del producto.

Si transmite el producto a terceras personas, entregue también este manual de instrucciones.

- Mantenga el producto y el embalaje alejados de los niños. El producto no es un juguete. Es necesario vigilar a los niños para evitar que jueguen con el producto.
- ¡Peligro de muerte por descarga eléctrica! Antes del montaje del producto o al realizar otras tareas, cerciúrese siempre de que el suministro de corriente esté siempre desconectado. Asegure la caja de distribución contra un reencendido por parte de terceros, p. ej. con un rótulo de advertencia.

- Compruebe siempre antes de conectar el producto que la tensión nominal coincida con los datos de la placa de característica del producto.
- La superficie y los materiales de fijación deben poder mantener el producto con seguridad. En caso de duda, póngase en contacto con una persona especializada.
- ¡Peligro de muerte por descarga eléctrica! Asegúrese de no dañar los conductos de agua y electricidad o las líneas de teléfono al realizar las perforaciones. Utilice un dispositivo especial para buscar los conductos y líneas.
- Este producto corresponde con el tipo de protección IP54: Protegido contra la penetración de polvo a partículas peligrosas y sensibles. Protección contra salpicaduras de agua. No sumergir el producto en agua.
El tipo de protección IP solo se garantiza si el producto está montado correctamente.
- Nunca toque el producto con las manos húmedas o mojadas.
- Asegúrese de que el cable de conexión no esté tenso ni en contacto con objetos afilados, productos químicos o disolventes.
- Compruebe regularmente la presencia de daños en el enchufe y en el cable de conexión.
- A fin de evitar peligros, cualquier cable flexible exterior dañado de esta lámpara deberá ser cambiado exclusivamente por el fabricante, su representante del servicio autorizado o un especialista comparable.



El producto cumple con la clase de protección I y, por tanto, debe ser conectado al conductor de protección.



¡Peligro de muerte por descarga eléctrica! El uso, manejo o montaje indebido conlleva el riesgo de un peligro de muerte por descarga eléctrica. ¡El producto solo debe ser conectado por un especialista eléctrico!



No mire directamente al haz luminoso.

No ilumine a otras personas en la cara. Si esto sucede durante un largo periodo de tiempo, puede resultar peligroso para la retina debido a la luz azul.



El vidrio de seguridad no es intercambiable. Elimine el producto si el vidrio de seguridad se daña.

- Ya no será posible que el producto funcione de forma segura si presenta daños visibles. Reparar o eliminar el producto si está dañado.
- ¡No repare el producto por cuenta propia! Deje que un especialista eléctrico realice las reparaciones.
- La fuente de luz de esta lámpara no es intercambiable. Reemplace la totalidad de la lámpara una vez finalizada la vida útil de la fuente de luz.
- ¡Atención! Para la conexión, emplear únicamente un cable de la categoría H05RN-F 3G 1 mm² o superior.

i DESCRIPCIÓN DEL PRODUCTO

(véase la página 2)

- | | |
|-------------------------|-------------------------------|
| 1 LED | 3 Cable de conexión |
| 2 Tornillos de fijación | 4 Soporte de fijación/montaje |

i MONTAJE

- Interrumpa el suministro de corriente al cable en la caja de distribución y asegúrela contra una reconexión por parte de terceros.
- Escoja una posición de montaje adecuada para el producto.

Notas:

Los agujeros de fijación del soporte tienen un diámetro de 5 mm. Seleccione el material de montaje adecuado.

Los materiales de montaje no están incluidos. A modo de ejemplo, el montaje en estas instrucciones se muestra con 2 tornillos y 2 tacos. Según sea necesario, puede emplear otros materiales de montaje.

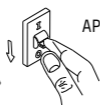

APAGADO

1.

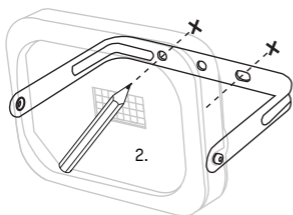

2.

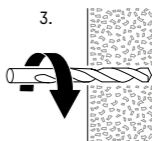

3.

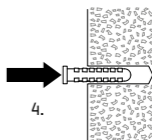

4.

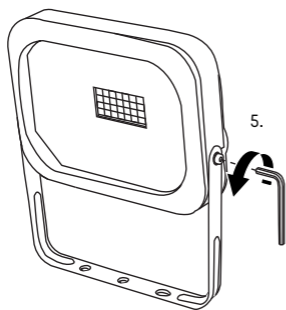

5.

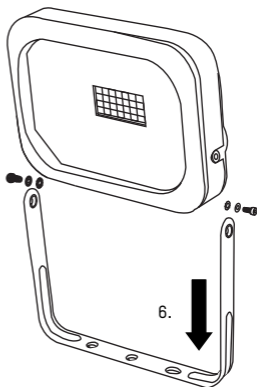

6.

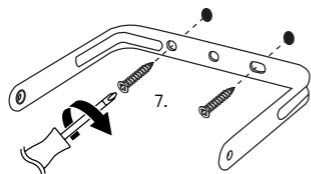

7.

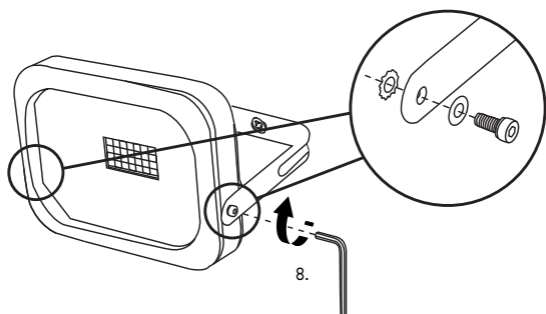

CONEXIÓN

- Conecte los conductores conforme a las marcas:

L	Fase	(marrón)
	Tierra	(amarillo-verde)
N	Neutro	(azul)

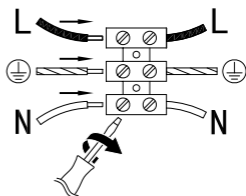

- Establece de nuevo el suministro de tensión.

i AJUSTE DEL FARO

- Afloje los tornillos de fijación.

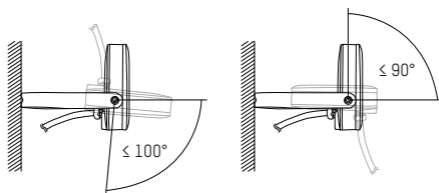

- Ajuste el ángulo deseado del foco (-100° a $+90^\circ$).

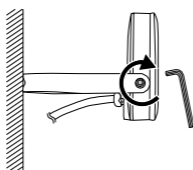

- Apriete bien los tornillos de fijación con una llave de hexágono interior.

i LIMPIEZA

- Interrumpa el suministro de tensión al producto en la caja de distribución antes de cada limpieza. Asegure el producto contra un reencendido no intencionado colocando un rótulo indicativo en la caja de distribución.
- Para la limpieza, utilice únicamente un paño suave, seco o ligeramente humedecido (en su caso, añada un poco de detergente de lavavajillas suave). En ningún caso utilice para la limpieza productos abrasivos o disolventes.

DATOS TÉCNICOS

Modelo	1600-0280: WFL800	1600-0281: WFL1600	1600-0282: WFL2400
Tensión de conexión	220-240 V~, 50/60 Hz		
Potencia en vatios	10 W	20 W	30 W
Tipo de protección IP	IP54 (protección contra salpicaduras de agua)		
Clase de protección	I		
Tipo de lámpara	LED		
Temperatura de color	5000 K		
Flujo luminoso nominal	900 lm	1800 lm	2700 lm
Superficie de proyección máxima	200 cm ²	385 cm ²	470 cm ²
Lugar de montaje	Interior y exterior		
Altura de montaje	máx. 3 m		
Temperatura de servicio t _a	-20 a +50 °C		
Dimensiones del vidrio (A x Al x P) – aprox.	124 x	177 x	201 x
	90 x	127 x	146 x
	4 mm	4 mm	4 mm
Dimensiones con soporte (A x Al x P) – aprox.	147 x	202 x	231 x
	136 x	190 x	202 x
	42 mm	34 mm	41 mm
Peso	0,44 kg	0,82 kg	1,15 kg

ELIMINACIÓN



Elimine la lámpara inutilizable conforme a las disposiciones legales. La identificación "Contenedor de basura" indica que el aparato eléctrico en la UE no debe ser eliminado en la basura doméstica. Utilice los sistemas de devolución y recogida de su comunidad o póngase directamente en contacto con el distribuidor del producto.

De este modo, cumple con sus obligaciones legales y ayuda a proteger el medio ambiente.

LIMITACIONES DE RESPONSABILIDAD

La información contenida en este manual de instrucciones puede ser modificada sin previo aviso. ANSMANN no acepta ninguna responsabilidad por daños directos, indirectos, accidentales o derivados, que se originen por un uso inadecuado o por la no contemplación de la información contenida en este manual de instrucciones. No aceptamos ninguna responsabilidad ni ofrecemos ningún derecho de garantía por un uso inadecuado del producto.

INFORMACIÓN SOBRE LA GARANTÍA

Ofrecemos diez años de garantía por el producto. No se puede ofrecer garantía alguna en caso de daños que se originen en el producto por la no observación del manual de instrucciones.

De este modo, su derecho de garantía legal no se verá afectada.

Nuestras disposiciones de garantía se pueden consultar en www.ansmann.de



www.tuv.com
ID 141900831



1600-0280
1600-0281



El producto cumple las exigencias de las Directivas de la UE.



www.tuv.com
ID 141900832



1600-0282

TRADUÇÃO DO MANUAL ORIGINAL

REFLETOR DE PAREDE

WFL800 | WFL1600 | WFL2400

ÍNDICE

Conteúdo da embalagem	39
Legenda.....	40
Utilização adequada	40
Instruções de segurança	40
Descrição do produto	42
Instalação.....	42
Ligação	44
Configurar o refletor	45
Limpeza.....	45
Dados técnicos	46
Eliminação	47
EXONERAÇÃO	47
INDICAÇÃO DE GARANTIA.....	47

CONTEÚDO DA EMBALAGEM

- 1x Refletor de parede
- 1x Manual de instruções

Ao desempacotar o produto verifique a integridade do conteúdo da embalagem e a existência de eventuais danos. Nunca utilize um produto danificado. Se verificar danos no produto contacte o seu fabricante.

LEGENDA

Tenha em consideração os seguintes sinais e as palavras que são utilizados no manual de instruções, no produto e na embalagem.

 = Informações

Informação adicional útil sobre o produto

 = Nota

Esta nota alerta para a existência de qualquer dano possível

 = Aviso

Atenção – Perigo! Pode causar ferimentos graves ou a morte.

 = Classe de proteção I

 = Perigo de choque elétrico.

 = Não olhe para o raio de luz

 →  = Não utilizar quando o vidro está danificado

UTILIZAÇÃO ADEQUADA

O produto foi concebido para iluminar entradas, corredores, espaços livres etc.

Este produto foi concebido exclusivamente para o uso doméstico, não sendo adequado para o uso industrial.

INSTRUÇÕES DE SEGURANÇA



Antes da utilização do produto leia cuidadosamente todo o manual de instruções. O manual de instruções contém informações importantes referente à utilização do produto. Se este produto for dado a terceiros, o presente manual de instruções deve ser dado também.

- Mantenha as crianças fora do alcance do produto e da embalagem. O produto não é um brinquedo. As crianças devem ser vigiadas para assegurar que não brincam com o produto.
- Perigo de morte devido a choque elétrico! Certifique-se de que a alimentação esteja desligado antes de começar a montagem e outras atividades no produto. Protege o quadro elétrico contra a ligação por terceiros, p.ex., com uma placa de aviso.

- Antes de ligar o produto verifique sempre se a tensão de alimentação indicada na placa do produto é compatível com a tensão do local.
- A base de fixação e os materiais para fixar devem fixar o produto de forma segura. Em caso de dúvidas consulte uma pessoa qualificada.
- Perigo de morte devido a choque elétrico! Ao fazer os orifícios certifique-se de que não danifique ligações de água, eletricidade ou telefone. Utilize um detetor de ligações.
- O produto está conforme a norma de segurança IP54: Protegido contra a entrada de pó e peças perigosas e sensíveis. Proteção contra salpicos de água. Não mergulhe o produto por baixo de água.
O grau de proteção IP só é garantido quando o produto está instalado devidamente.
- Não toque no produto com as mãos húmidas ou molhadas.
- Certifique-se de que o cabo da ligação não esteja esticado e de que não entre em contacto com objetos afiados, químicos ou solventes.
- Verifique regularmente o cabo de ligação e a ficha se apresentam danos.
- Os cabos externos e flexíveis que estão danificados só podem ser substituídos pelo fabricante, serviço de cliente ou por uma pessoa autorizada a fim de evitar perigos.



O produto pertence à classe de proteção I e deve ser ligado a um condutor de proteção.



Perigo de morte devido a choque elétrico! A utilização e montagem indevida representa um risco de choque elétrico grave. O produto só deve ser ligado por um electricista qualificado!



Não olhe diretamente para o raio de luz.
Não direcione o raio de luz para a cara de outras pessoas. Se o raio de luz estiver muito tempo apontado para a cara pode causar danos na retina por radiação de luz azul.



O vidro de segurança não é substituível. Quando o vidro de proteção estiver danificado deve eliminar o produto.

- Quando o produto apresentar danos visíveis o funcionamento sem perigos já não é garantido. O produto deve ser eliminado ou reparado quando estiver danificado.

- Não tente de realizar reparações por conta própria. As reparações só devem ser efetuadas por eletricitas autorizados.
- A fonte de luz do presente refletor não é substituível. Quando a vida útil da fonte de luz termina, deve substituir o refletor todo.
- Atenção! Para a ligação só pode ser utilizado um cabo de ligação que pertence à categoria H05RN-F 3G 1 mm² ou superior.

i DESCRIÇÃO DO PRODUTO

(ver página 2)

- | | |
|------------------------|-----------------------------|
| 1 LEDs | 3 Cabo de ligação |
| 2 Parafusos de fixação | 4 Apoio de fixação/montagem |

i INSTALAÇÃO

- Desligue a alimentação do cabo diretamente no quadro elétrico e proteja-o contra uma ligação acidental por terceiros.
- Escolhe a posição adequada para montar o produto.

Notas:

Os orifícios de fixação do apoio dispõem de um diâmetro de 5 mm. Selecione o material de montagem adequado.

Os materiais de montagem não estão incluídos no fornecimento. Segundo o exemplo do presente manual a montagem é apresentada com 2 parafusos e 2 buchas. Se necessário podem ser utilizados outros materiais de montagem.

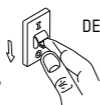

DESLIGADO

1.

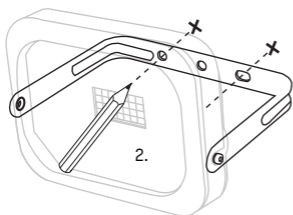

2.

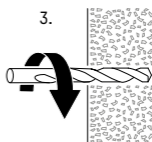

3.

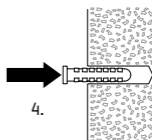

4.

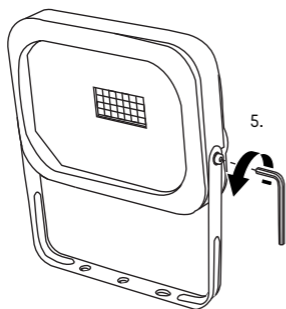

5.

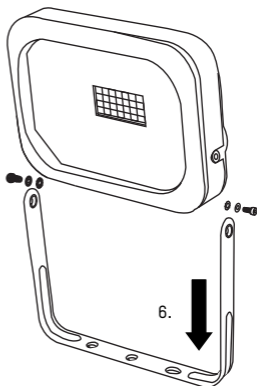

6.

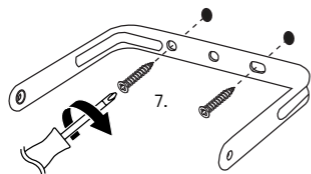

7.

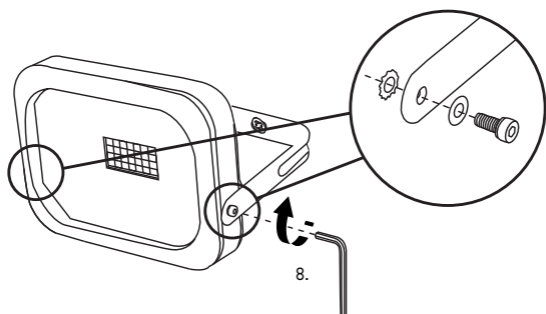

LIGAÇÃO

- Ligue os fios conforme as marcações:

L	Fase	(castanho)
	Ligação à terra	(amarelo-verde)
N	Neutro	(azul)

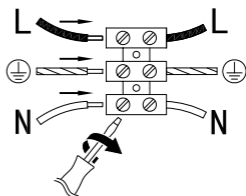

- Volte a ligar a alimentação.

i CONFIGURAR O REFLETOR

- Solte os parafusos de fixação.

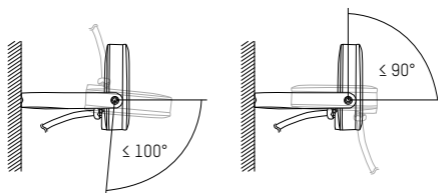

- Configure o ângulo desejado do refletor (-100° a +90°).

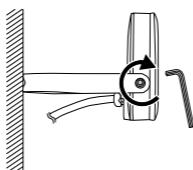

- Fixe os parafusos de fixação com uma chave hexagonal.

i LIMPEZA

- Antes de cada limpeza desliga a alimentação elétrica do produto diretamente no quadro elétrico. Protege o produto contra a ligação não intencionada colocando uma placa de aviso no quadro elétrico.
- Para a limpeza utilize sempre um pano suave, seco ou pouco húmido (se necessário pode adicionar um pouco de detergente suave). Para a limpeza não utilize detergentes abrasivos ou solventes.

DADOS TÉCNICOS

Modelo	1600-0280: WFL800	1600-0281: WFL1600	1600-0282: WFL2400
Tensão de ligação	220-240 V~, 50/60 Hz		
Potência em Watt	10 W	20 W	30 W
Grau de proteção IP	IP54 (proteção contra salpicos de água)		
Classe de proteção	I		
Tipo de luz	LED		
Cor da temperatura	5000 K		
Tensão nominal da luz	900 lm	1800 lm	2700 lm
Superfície máxima de projeção	200 cm ²	385 cm ²	470 cm ²
Local da montagem	Interior e exterior		
Altura da montagem	máx. 3 m		
Temperatura de funcionamento t _a	-20 a +50 °C		
Dimensões vidro (L x A x P) – aprox.	124 x	177 x	201 x
	90 x	127 x	146 x
	4 mm	4 mm	4 mm
Dimensões com apoio (L x A x P) – aprox.	147 x	202 x	231 x
	136 x	190 x	202 x
	42 mm	34 mm	41 mm
Peso	0,44 kg	0,82 kg	1,15 kg

ELIMINAÇÃO



Elimine a lanterna usada de acordo com os regulamentos em vigor. O símbolo "caixote de lixo" indica que os aparelhos elétricos na EU têm de ser eliminados de forma separada dos resíduos domésticos. Aproveite os ecopontos da sua freguesia ou consulte o fornecedor onde comprou o produto.

Desta forma está a cumprir a lei obrigatória e a contribuir à proteção do ambiente.

EXONERAÇÃO

Todas as informações do presente manual podem ser alteradas sem aviso prévio. ANSMANN não se responsabiliza por danos diretos, indiretos, acidentais ou danos subsequentes que resultam de uma utilização indevida ou incumprimento das instruções de segurança do presente manual. Em caso de utilização indevida do produto não assumimos qualquer responsabilidade e não concedemos a garantia.

INDICAÇÃO DE GARANTIA

O aparelho tem uma garantia de dez anos. Em caso de danos que resultam do incumprimento do manual de instruções, a garantia fica anulada. Neste caso o direito à garantia não fica afetado.

Os nossos regulamentos da garantia podem ser consultados em www.ansmann.de



www.tuv.com
ID 141908831



1600-0280
1600-0281



O produto cumpre com as Diretivas Europeias.



www.tuv.com
ID 141908822



1600-0282

ÖVERSÄTTNING AV BRUKSANVISNING I ORIGINAL

VÄGGSTRÅLKASTARE

WFL800 | WFL1600 | WFL2400

INNEHÅLLSFÖRTECKNING

Leveransens innehåll	48
Teckenförklaring	49
Avsedd användning	49
Säkerhetsåtgärder	49
Produktbeskrivning	51
Montering	51
Anslutning	53
Ställa in strålkastare	54
Rengöring	54
Specifikationer	55
Avfallshantering	56
ANSVARFRISKRIVNING	56
GARANTIANVISNING	56

LEVERANSENS INNEHÅLL

1x Väggstrålkastare

1x Bruksanvisning

Packa först upp produkten och kontrollera att den är komplett och oskadad. Använd inte en skadad produkt. Om skador på produkten konstateras, vänligen kontakta din handlare.

TECKENFÖRKLARING

Beakta följande tecken och ord, som används i bruksanvisningen, på produkten och förpackningen.

 = Information

Nyttig tilläggsinformation om produkten

 = Anmärkning

Denna anmärkning varnar för möjliga skador av alla typer



 = Varning

Observera – Fara! Kan leda till svåra personskador eller dödsfall

 = Skyddsklass I

 = Risk för elstötar

 = Se inte in i ljusstrålen

 →  = Använd inte vid glasbrott

AVSEDD ANVÄNDNING

Produkten används för belysning av infarter, passager, fria ytor osv.

Produkten tjänar uteslutande för privat bruk i hushåll och är inte avsedd för kommersiell användning.

SÄKERHETSÅTGÄRDER



Innan du tar produkten i bruk, vänligen läs noga hela bruksanvisningen. Den innehåller viktig information angående säker hantering av produkten.

Om du lämnar vidare produkten till tredje man, så skall denna bruksanvisning också överlämnas.

- Håll barn borta från produkten och förpackningen. Produkten är inte en leksak. Barn bör övervakas för att se till att de inte leker med produkten.
- Livsfara på grund av elstöt! Säkerställ alltid att strömtillförseln är bruten innan monteringen eller andra arbeten på produkten. Säkra kopplingslådan mot återstart av tredje man med t.ex. en varningsskylt.
- Kontrollera alltid att nätspänningen stämmer överens med uppgifterna på produktens typskylt innan du ansluter produkten.

- Infästningsunderlaget och infästningsmaterialen skall kunna hålla produkten säkert. I tveksamma fall vänder du dig till en sakkunnig person.
- Livsfara på grund av elstöt! Se till att du inte skadar vatten-, ström- eller telefonledningar när du borrar. Använd en ledningsdetektor.
- Denna produkt uppfyller kraven för skyddsklass IP54: Skyddad mot inträngande stoft i farliga och känsliga delar. Stänkvattenskyddad. Doppa inte produkten i vatten. IP-skyddsklassen är endast säkerställt vid en korrekt monterad produkt.
- Fatta inte tag i produkten med våta eller fuktiga händer.
- Kontrollera, att anslutningskabeln inte är spänd eller kommer i kontakt med vassa föremål, kemikalier eller lösningsmedel.
- Kontrollera regelbundet att anslutningsledningen och nätstickkontakten inte är skadade.
- För att undvika faror får en skadad yttre flexibel ledning till denna lampa endast bytas ut av tillverkaren, dennes servicerepresentant eller en jämförbar utbildad person.



Produkten uppfyller kraven i skyddsklass I och skall därför anslutas till ett jordat uttag.



Livsfara på grund av elstöt! En felaktig användning, hantering eller montering innebär risk för en livsfarlig elstöt. Produkten får endast anslutas av en behörig elektriker!



Titta inte direkt in i ljusstrålen.

Lys inte andra personer in i ansiktet. Om detta sker under alltför lång stund kan genom blåljusets inverkan en skada på ögats näthinna uppträda.



Säkerhetsglaset kan inte bytas ut. Vid ett skadat säkerhetsglas skall produkten avfallshanteras.

- En riskfri drift är inte längre möjlig om produkten uppvisar synliga skador. Om produkten är skadad skall den avfallshanteras eller repareras.
- Reparera inte produkten själv. Låt endast en behörig elektriker utföra reparationer.

- Denna armaturs ljuskälla är inte utbytbar. När ljuskällans livstid tar slut, måste hela armaturen bytas ut.
- Observera! För att göra en anslutning får endast en anslutningskabel i kategorin H05RN-F 3G 1 mm² eller högre kvalitet användas.

i PRODUKTBESKRIVNING

(se sidan 2)

- | | |
|---------------------|---------------------------|
| 1 LED:er | 3 Anslutningsledning |
| 2 Arreteringskruvar | 4 Hållar-/monteringsbygel |

i MONTERING

- Bryt strömförsörjningen till kabeln direkt på kopplingslådan och säkra denna mot återstart utförd av utomstående.
- Välj en lämplig monteringsposition för produkten.

Anmärkningar:

Infästningshålen i bygeln har en diameter på 5 mm. Välj passande monteringsmaterial.

Monteringsmaterial medföljer inte. Såsom ett exempel visas i denna anvisning montering med 2 skruvar och 2 pluggar. Beroende på behov kan du använda andra monteringsmaterial.

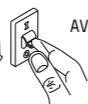

1.

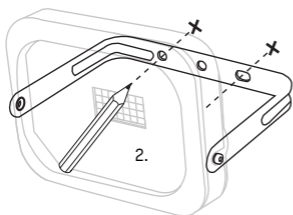

2.

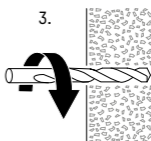

3.

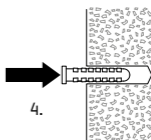

4.

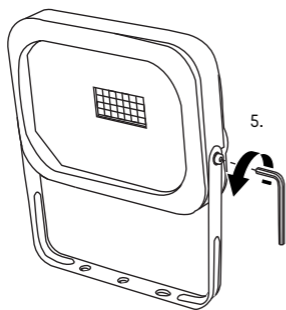

5.

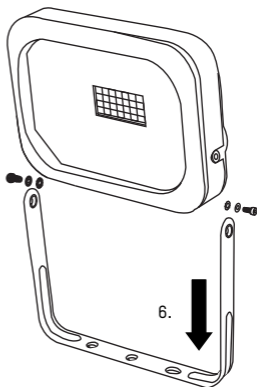

6.

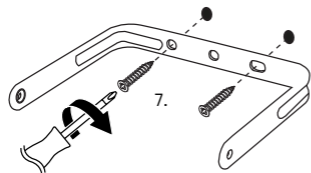

7.

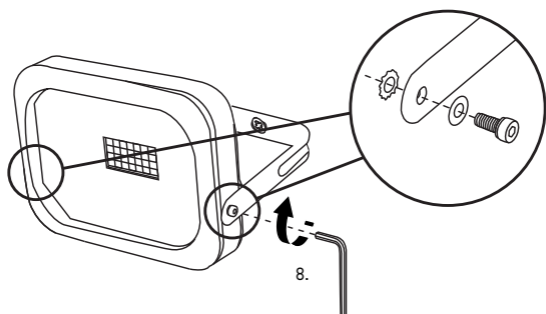

ANSLUTNING

- Anslut ledarna i enlighet med markeringarna:

L	Fas	(brun)
	Jordning	(gul-grön)
N	Neutral	(blå)

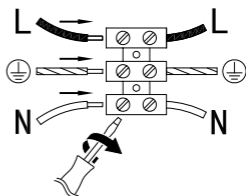

- Återupprätta spänningsförsörjningen.

i STÄLLA IN STRÅLKASTARE

- Lossa arreteringskruvarna.

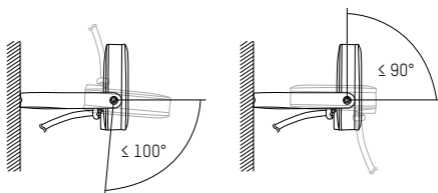

- Ställ in strålkastarens önskade vinkel (-100° till +90°).

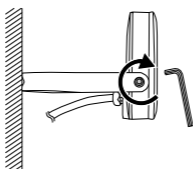

- Dra åt arreteringskruvarna igen med en insexnyckel.

i RENGÖRING

- Bryt spänningsförsörjningen till produkten på kopplingskåpet innan varje rengöring. Säkra produkten mot oavsiktlig återstart genom att placera en anvisningsskylt på kopplingskåpet.
- Använd för rengöring framför allt en mjuk, torr eller lätt fuktad duk (dränk den eventuellt med lite diskmedel). Använd aldrig slipnings- eller lösningsmedel till rengöringen.

SPECIFIKATIONER

Modell	1600-0280: WFL800	1600-0281: WFL1600	1600-0282: WFL2400
Anslutningsspänning	220-240 V~, 50/60 Hz		
Effekt i Watt	10 W	20 W	30 W
IP-skyddsklass	IP54 (stänkvattenskyddad)		
Skyddsklass	I		
Typ av ljuskälla	LED		
Färgtemperatur	5000 K		
Nominell ljusström	900 lm	1800 lm	2700 lm
Maximal projektyta	200 cm ²	385 cm ²	470 cm ²
Monteringsställe	Inomhus och utomhus		
Monteringshöjd	max. 3 m		
Driftstemperatur t _a	-20 till +50 °C		
Mått glas (B x H x D) – ca.	124 x 90 x 4 mm	177 x 127 x 4 mm	201 x 146 x 4 mm
Mått med bygel (B x H x T) – ca.	147 x 136 x 42 mm	202 x 190 x 34 mm	231 x 202 x 41 mm
Vikt	0,44 kg	0,82 kg	1,15 kg

AVFALLSHANTERING



Hantera den inte längre brukbara armaturen enligt de lagstadgade bestämmelserna. Märkningen "soptunna" anger att EU inte tillåter elektriska anordningar att avfallshandteras tillsammans med normal hushållsavfall. Använd dig av det retur- och samlingssystem som finns i din kommun eller vänd dig till den handlare hos vilken du köpt produkten.

På så sätt uppfyller du dina lagenliga plikter och ger ditt bidrag till miljöskydd.

ANSVARFRISKRIVNING

Den i denna bruksanvisning angivna informationen kan komma att ändras utan föravisering. ANSMANN påtar sig inte något ansvar för direkta, indirekta, tillfälliga eller andra skador eller följdskador som uppstår genom felaktig hantering eller bristande hänsyn till den information som anges i denna bruksanvisning. Vid felaktig användning av produkten påtar vi oss inget ansvar och beviljar ingen garantiersättning.

GARANTIANVISNING

Vi erbjuder tio års garanti på produkten. Vid skador på produkten, som uppkommer om bruksanvisningen inte beaktas, gäller inte garantin. Ditt lagstadgade anspråk på garanti påverkas inte av detta.

Våra garantivillkor finns online på www.anmann.de



www.br.com
ID 141908831



1600-0280
1600-0281



Produkten motsvarar kraven i EU:s riktlinjer.



www.br.com
ID 141908822



1600-0282

TRADUZIONE DELLE ISTRUZIONI ORIGINALI

FARETTO DA PARETE

WFL800 | WFL1600 | WFL2400

INDICE

Contenuto della confezione.....	57
Spiegazione dei simboli.....	58
Uso previsto.....	58
Avvertenze per la sicurezza	58
Descrizione del prodotto	60
Montaggio.....	60
Collegamento	62
Regolazione del faretto	63
Pulizia.....	63
Dati tecnici	64
Smaltimento	65
ESCLUSIONI DI RESPONSABILITÀ	65
AVVISO SULLA GARANZIA	65

CONTENUTO DELLA CONFEZIONE

1x Faretto da parete

1x Istruzioni per l'uso

Per prima cosa disimballare il prodotto e verificare la completezza e gli eventuali danni. Non utilizzare un prodotto danneggiato. Se si notano danni al prodotto, contattare il proprio rivenditore.

SPIEGAZIONE DEI SIMBOLI

Si prega di osservare i seguenti simboli e parole utilizzati nel manuale di istruzioni, sul prodotto e sulla confezione.

 = Informazioni

Ulteriori informazioni utili sul prodotto

 = Nota

Questo avviso avverte di possibili danni di qualsiasi tipo

 = Avvertenza

Attenzione – Pericolo! Può portare a gravi lesioni o morte

 = Classe di protezione I

 = Pericolo di scosse elettriche

 = Non guardare nel fascio di luce

 →  = Non azionare in caso di rottura del vetro

USO PREVISTO

Il prodotto serve all'illuminazione di ingressi, passaggi, spazi aperti, ecc.

Il prodotto è destinato esclusivamente ad uso domestico privato e non ad uso commerciale.

AVVERTENZE PER LA SICUREZZA



Leggere attentamente il manuale di istruzioni completo prima di mettere in funzione il prodotto. Contiene importanti istruzioni per la manipolazione del prodotto.

In caso di cessione del prodotto a terzi, consegnare il presente manuale di istruzioni.

- Tenere i bambini lontani dal prodotto e dall'imballaggio. Questo prodotto non è un giocattolo. I bambini devono essere sorvegliati per assicurarsi che non giochino con il prodotto.
- Pericolo di morte per folgorazione! Assicurarsi sempre che l'alimentazione elettrica sia scollegata prima di installare o eseguire qualsiasi altro lavoro sul prodotto. Assicurare la scatola degli interruttori per evitare che venga reinserita da terzi, ad es. con un segnale di avvertimento.

- Prima di collegare il prodotto, verificare sempre che la tensione nominale corrisponda al valore riportato sulla targhetta dello stesso.
- La superficie e i materiali di montaggio devono essere in grado di fissare saldamente il prodotto. In caso di dubbio, contattare una persona qualificata.
- Pericolo di morte per folgorazione! Assicurarsi che durante l'esecuzione dei fori non danneggiare tubi dell'acqua, cavi elettrici o telefonici. Utilizzare un localizzatore di tensione.
- Questo prodotto è conforme alla classe di protezione IP54: Protetto contro l'ingresso di polvere in parti pericolose e sensibili. Resistente agli spruzzi d'acqua. Non immergere il prodotto in acqua. La classe di protezione IP è garantita solo se il prodotto è installato correttamente.
- Evitare di toccare il prodotto con mani umide o bagnate.
- Verificare sempre che il cavo di collegamento non sia eccessivamente teso e non entri in contatto con oggetti aguzzi, agenti chimici o solventi.
- Controllare regolarmente che il cavo di alimentazione e la spina non presentino danni.
- Per evitare pericoli, un cavo flessibile esterno danneggiato di questo apparecchio può essere sostituito solo dal produttore, dal suo rappresentante dell'assistenza o da uno specialista analogo.



Il prodotto rientra nella classe di protezione I, pertanto deve essere collegato alla messa a terra.



Pericolo di morte per folgorazione! L'uso, il funzionamento o il montaggio improprio comporta il rischio di scosse elettriche potenzialmente letali. Il prodotto può essere collegato solo da un elettricista qualificato!



Evitare di dirigere lo sguardo verso il fascio luminoso. Non far brillare in faccia agli altri. Se questo accade per troppo tempo, i componenti di luce blu possono mettere in pericolo la retina.



Il vetro di sicurezza non è sostituibile. In caso di vetro di sicurezza danneggiato, smaltire il prodotto.

- Se il prodotto ha danni visibili non è più possibile un funzionamento in sicurezza. Se il prodotto è danneggiato, deve essere smaltito o riparato.
- Evitare di riparare il prodotto da soli! Fate eseguire le riparazioni da un elettricista professionale.
- La sorgente luminosa di questa lampada non è sostituibile. Quando la durata della sorgente luminosa termina, la lampada deve essere sostituita.
- Attenzione! Per il collegamento può essere utilizzato solo un cavo di categoria H05RN-F 3G 1 mm² o superiore.

DESCRIZIONE DEL PRODOTTO

(vedi pagina 2)

- | | |
|----------------------|-------------------------------|
| 1 LED | 3 Cavo di alimentazione |
| 2 Viti di bloccaggio | 4 Staffa di ritegno/montaggio |

MONTAGGIO

- Scollegare l'alimentazione elettrica al cavo direttamente dalla scatola degli interruttori e assicurarsi che non venga reinserita da terzi.
- Scegliere una posizione di montaggio adatta al prodotto.

Note:

I fori di montaggio nella staffa hanno un diametro di 5 mm. Scegliere il materiale di montaggio appropriato.

Il materiale di montaggio non viene fornito. A titolo di esempio, in questo manuale viene illustrato il montaggio con 2 viti e 2 tasselli. Se necessario, è possibile utilizzare altri materiali di montaggio.

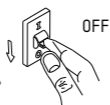

1.

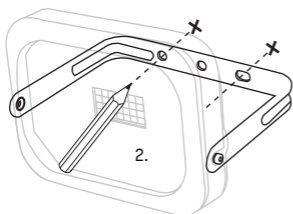

2.

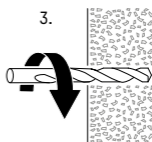

3.

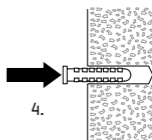

4.

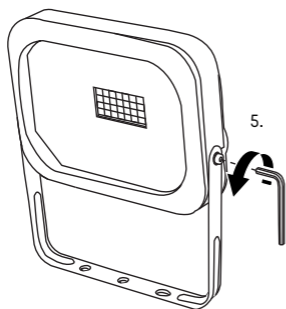

5.

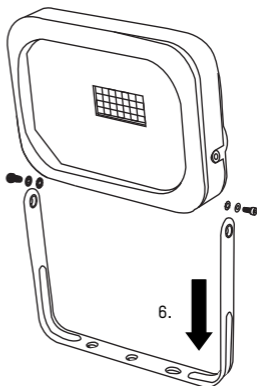

6.

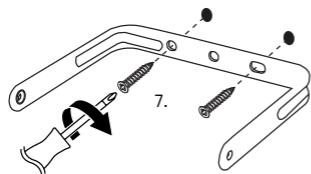

7.

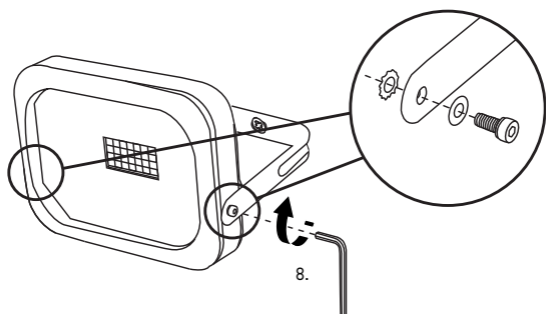

COLLEGAMENTO

- Collegare i fili secondo i contrassegni:

L	Fase	(marrone)
	Messa a terra	(giallo-verde)
N	Neutro	(blu)

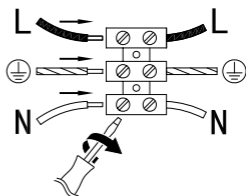

- Ricollegare l'alimentazione elettrica.

i REGOLAZIONE DEL FARETTO

- Allentare le viti di bloccaggio.

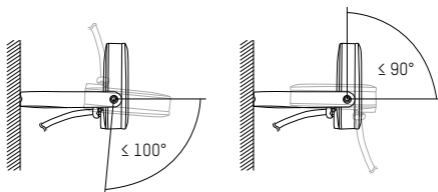

- Regolare l'angolo desiderato del faretto (da -100° a +90°).

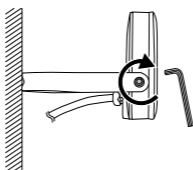

- Serrare le viti di bloccaggio con una chiave a brugola.

i PULIZIA

- Scollegare l'alimentazione elettrica al prodotto direttamente dalla scatola degli interruttori prima di ogni pulizia. Bloccare il prodotto per evitare un riavvio accidentale posizionando un cartellino sulla scatola degli interruttori.
- Per la pulizia utilizzare solo un panno morbido, asciutto o leggermente umido (se necessario aggiungere un po' di detersivo delicato per piatti). Non utilizzare mai abrasivi o solventi per la pulizia.

DATI TECNICI

Modello	1600-0280: WFL800	1600-0281: WFL1600	1600-0282: WFL2400
Tensione di alimentazione	220-240 V~, 50/60 Hz		
Potenza in watt	10 W	20 W	30 W
Protezione IP	IP54 (resistente agli spruzzi d'acqua)		
Classe di protezione	I		
Tipo di lampada	LED		
Temperatura di colore	5000 K		
Flusso luminoso nominale	900 lm	1800 lm	2700 lm
Superficie massima di proiezione	200 cm ²	385 cm ²	470 cm ²
Luogo di montaggio	Interno ed esterno		
Altezza di montaggio	max. 3 m		
Temperatura di esercizio t _a	da -20 a +50 °C		
Dimensioni vetro (L x H x P) – circa	124 x	177 x	201 x
	90 x	127 x	146 x
	4 mm	4 mm	4 mm
Dimensioni (L x H x P) – circa	147 x	202 x	231 x
	136 x	190 x	202 x
	42 mm	34 mm	41 mm
Peso	0,44 kg	0,82 kg	1,15 kg

SMALTIMENTO



Smaltire la lampada inutilizzabile in conformità alle disposizioni di legge. L'etichetta "bidone della spazzatura" indica che gli apparecchi elettrici non possono essere smaltiti con i normali rifiuti domestici nell'UE. Utilizzare i sistemi di restituzione e raccolta nel proprio comune o contattare il rivenditore presso il quale il prodotto è stato acquistato.

In questo modo si rispettano gli obblighi di legge contribuendo al contempo alla tutela ambientale.

ESCLUSIONI DI RESPONSABILITÀ

Le informazioni contenute in questo manuale sono soggette a modifiche senza preavviso. L'ANSMANN non è responsabile per danni diretti, indiretti, incidentali, consequenziali o altri derivanti dall'uso improprio o dal mancato rispetto delle informazioni contenute in questo manuale. In caso di uso improprio del prodotto non ci assumiamo alcuna responsabilità e non concediamo alcuna garanzia o diritti alla garanzia.

AVVISO SULLA GARANZIA

Offriamo una garanzia di dieci anni sul prodotto. In caso di danni al prodotto dovuti all'inosservanza delle istruzioni per l'uso, non può essere fornita alcuna garanzia.

Ciò non pregiudica il proprio diritto legale alla garanzia.

Le nostre condizioni di garanzia sono contenute online sul sito www.ansmann.de



www.tuv.com
ID 141906831



1600-0280
1600-0281



Il prodotto è conforme ai requisiti delle Direttive UE.



www.tuv.com
ID 141906832



1600-0282

VERTALING VAN DE OORSPRONKELIJKE GEBRUIKSAANWIJZING

MUURSTRALER

WFL800 | WFL1600 | WFL2400

INHOUDSOPGAVE

Leveringsomvang.....	66
Verklaring van de symbolen.....	67
Beoogd gebruik.....	67
Veiligheidsinstructies.....	67
Productbeschrijving.....	69
Installatie.....	69
Aansluiting.....	71
Breedstraler instellen.....	72
Schoonmaken.....	72
Technische Gegevens.....	73
Verwijdering.....	74
AANSPRAKELIJKHEIDSUITSLUITING.....	74
GARANTIEBEWIJS.....	74

LEVERINGSOMVANG

1x Muurstraler

1x Gebruiksaanwijzing

Pak het product eerst uit en controleer of er niets ontbreekt en of er geen sprake is van beschadigingen. Gebruik het product niet als het beschadigd is. Mocht u constateren dat het product beschadigd is, neem dan contact op met de verkoper.

VERKLARING VAN DE SYMBOLEN

Houd de hand aan de volgende tekens een aanwijzingen die in de gebruiksaanwijzing, op het product en op de verpakking gebruikt worden.

 = Informatie

Handige extra informatie over het product

 = Tip:

Deze aanwijzing waarschuwt voor mogelijke schade van allerlei soorten

 = WAARSCHUWING

Opgelet - Gevaar! Kan tot ernstige verwondingen of de dood leiden

 = Beschermingsklasse I

 = Gevaar voor elektrische schokken.

 = Niet in de lichtstraal kijken

 →  = Niet gebruiken al het glas gebroken is

BEOOGD GEBRUIK

Het product dient voor het verlichten van opritten, doorgangen, open ruimtes, etc.

Het product is uitsluitend bestemd voor privégebruik thuis en niet voor commercieel gebruik.

VEILIGHEIDSINSTRUCTIES



Lees voor ingebruikname van het product de volledige gebruiksaanwijzing zorgvuldig door. Er staan belangrijke aanwijzingen in over hoe het product gebruikt moet worden.

Als het product aan een derde ter hand wordt gesteld, geef dan deze gebruiksaanwijzing mee.

- Houd kinderen uit de buurt van het verpakkingsmateriaal. Het product is geen speelgoed. Kinderen moeten onder toezicht staan om er zeker van te zijn dat ze niet met het product gaan spelen.
- Levensgevaar door elektrische schokken! Vergewis uzelf ervan dat de stroomtoevoer voor het installeren of andere werkzaamheden aan het product altijd afgesloten is. Beveilig de schakelkast tegen per ongeluk inschakelen door een derde, bijv. met een waarschuwingsbriefje.

- Controleer altijd of de netspanning overeenkomt met wat aangegeven staat op het typeplaatje van het product voordat u dit aansluit.
- De ondergrond waarop en het materiaal waarmee het product wordt bevestigd, moeten stevig genoeg zijn. Neem bij twijfel contact op met een vakman.
- Levensgevaar door elektrische schokken! Let op dat u tijdens het boren van de gaten geen water-, stroom- of telefoonleidingen beschadigt. Gebruik een kabelzoeker.
- Dit product is conform beschermingswijze IP54: Beschermd tegen het binnendringen van stof in gevaarlijke en gevoelige onderdelen. Beschermd tegen spatwater. Product niet in water onderdompelen. De IP-beschermingswijze is alleen gegarandeerd als het product op de juiste wijze is geïnstalleerd.
- Raak het product nooit aan met natte of vochtige handen.
- Zorg ervoor dat de aansluitkabel niet strak gespannen is of in contact komt met scherpe voorwerpen, chemicaliën of oplosmiddelen.
- Controleer regelmatig of het aansluitsnoer en de netstekker mogelijk beschadigd zijn.
- Om gevaar te vermijden mag de beschadigde flexibele buitenleiding van deze straler alleen door de fabrikant, zijn serviceagent of een vergelijkbare vakman vervangen worden.



Het product voldoet aan de eisen van beschermingsklasse I en moet daarom aangesloten worden op een geaard stopcontact.



Levensgevaar door elektrische schokken! Onoordeelkundig gebruik, bediening of installatie brengt het risico op een levensgevaarlijke schok met zich mee. Het product mag uitsluitend door een vakkundige elektricien worden aangesloten.



Kijk niet direct in de lichtstraal.

Schijn ander mensen niet in hun gezicht. Gebeurt dit toch te lang, dan is dat door het blauwe licht van de straal gevaarlijk voor het netvlies.



Het veiligheidsglas kan niet worden vervangen. Als het veiligheidsglas beschadigd is, moet het product worden weggegooid.

- Gebruik zonder risico's is niet langer mogelijk als het apparaat zichtbare beschadigingen vertoont. Gooi het apparaat weg of repareer het als het beschadigd is.
- Repareer het product nooit zelf! Laat reparaties alleen uitvoeren door een elektricien.
- De lichtbron van deze lamp kan niet worden vervangen. Als de levensduur van de lichtbron verstreken is, moet de gehele schijnwerper worden vervangen.
- Opgelet! Om het product aan te sluiten mag alleen een kabel van het type H05RN-F 3G 1 mm² of van nog betere kwaliteit gebruikt worden.

i PRODUCTBESCHRIJVING

(zie blz. 2)

- | | |
|---------------|-----------------------------------|
| 1 LED's | 3 Aansluitleiding |
| 2 Borgschroef | 4 Bevestigings-/installatiebeugel |

i INSTALLATIE

- Onderbreek de stroomvoorziening naar de kabel direct in de schakelkast en bescherm deze tegen het weer aanzetten door derden.
- Kies een geschikte plaats om het product te bevestigen.

Tips:

De bevestigingsgaten in de beugel hebben een diameter van 5 mm. Kies geschikt montage materiaal.

Dit montage materiaal wordt niet meegeleverd. Als voorbeeld wordt in deze handleiding montage met behulp van 2 schroeven en 2 pluggen getoond. Naar behoefte kunt u ander montage materiaal gebruiken.

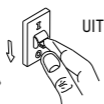

1.

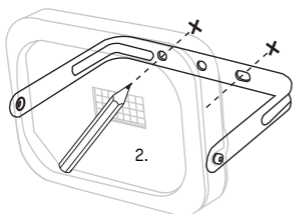

2.

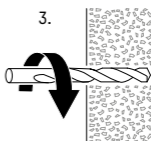

3.

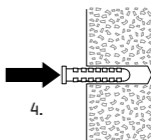

4.

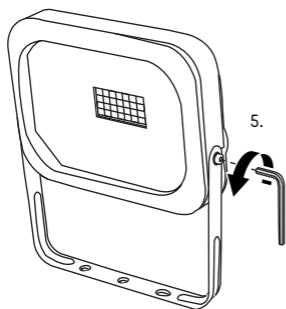

5.

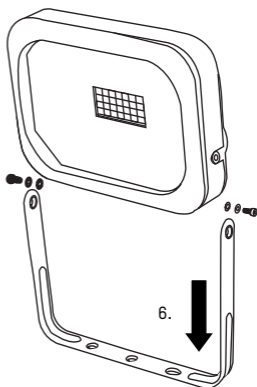

6.

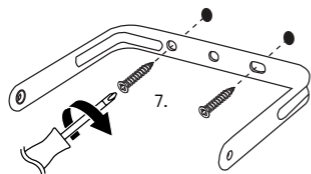

7.

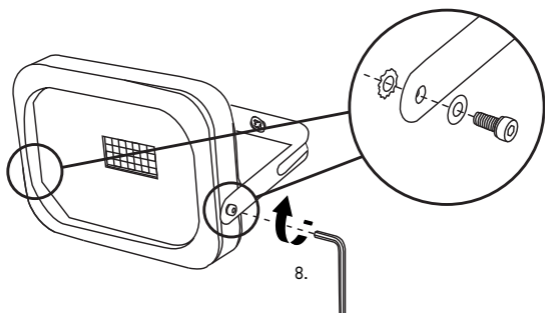

AANSLUITING

- Sluit de aders van het snoer aan conform de markeringen:

L Fase (bruin)

 Aarde (geel-groen)

N Neutraal (blauw)

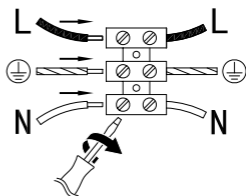

- Zet de stroomvoorziening weer aan.

i BREEDSTRALER INSTELLEN

- Draai de borgschroeven los.

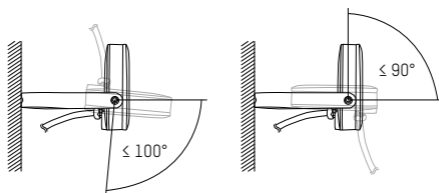

- Stel de gewenste hoek van de muurstraler in (-100° tot +90°).

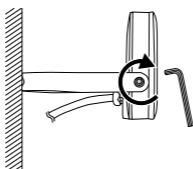

- Draai de borgschroeven met een inbussleutel vast.

i SCHOONMAKEN

- Onderbreek voor iedere schoonmaakbeurt de stroomvoorziening van het product in de schakelkast. Beveilig het product tegen per ongeluk opnieuw aanzetten door een waarschuwingsbriefje op de schakelkast aan te brengen.
- Gebruik voor het schoonmaken uitsluitend een zachte, droge of licht vochtige doek (indien nodig met toevoeging van een beetje mild schoonmaakmiddel). Gebruik voor het schoonmaken in ieder geval nooit schuur- of oplosmiddelen.

TECHNISCHE GEGEVENS

Model	1600-0280: WFL800	1600-0281: WFL1600	1600-0282: WFL2400
Aansluitspanning	220-240 V~, 50/60 Hz		
Vermogen (Watt):	10 W	20 W	30 W
IP-beschermingswijze	IP54 (beschermd tegen spatwater)		
Beschermingsklasse	I		
Type lichtelement	LED		
Kleurtemperatuur	5000 K		
Nominale lichtstroom	900 lm	1800 lm	2700 lm
Maximaal verlicht oppervlak:	200 cm ²	385 cm ²	470 cm ²
Installatieplaats	Binnen en buiten		
Installatiehoogte	max. 3 m		
Gebruikstemperatuur t _a	-20 tot +50 °C		
Afmetingen glas (H x B x D) – ca.	124 x	177 x	201 x
	90 x	127 x	146 x
	4 mm	4 mm	4 mm
Afmetingen met beugel (B x H x T) – ca.	147 x	202 x	231 x
	136 x	190 x	202 x
	42 mm	34 mm	41 mm
Gewicht	0,44 kg	0,82 kg	1,15 kg

i VERWIJDERING



Gooi onbruikbare lampen weg zoals wettelijk aangegeven. Het symbool "Afvalbak" duidt erop dat elektrische apparaten in de EU niet met het normale huishoudelijk afval weggegooid mogen worden. Gebruik de inleverings- en inzamelingssystemen van uw gemeente of wend u tot de bedrijven waar u het product hebt gekocht.

Zo vervult u uw wettelijke verplichtingen en draagt u bij tot de bescherming van het milieu.

i AANSPRAKELIJKHEIDSUITSLUITING

De informatie in deze gebruiksaanwijzing kan zonder aankondiging vooraf gewijzigd worden. ANSMANN houdt zichzelf niet verantwoordelijk voor directe, indirecte, toevallige of andere schade of gevolgschade die ontstaat door onvakkundig onderhoud of door het niet de hand houden aan de informatie in deze gebruiksaanwijzingen. Bij onjuist gebruik van het product houden wij ons niet aansprakelijk en zijn wij onontvankelijk voor garantie- of waarborgclaims.

i GARANTIEBEWIJS

Het product komt met een tienjarige garantie. Bij schade aan het apparaat die ontstaat door het niet de hand houden aan de gebruiksaanwijzing, vervalt de garantie.

Aan uw wettelijke aanspraak op schadevergoeding wordt hierdoor geen afbreuk gedaan.

Onze garantiebepalingen vindt u online op www.ansmann.de



www.tuv.com
ID 141908831



1600-0280
1600-0281



Het product voldoet aan de in de EU-richtlijnen gestelde eisen.



www.tuv.com
ID 141908822



1600-0282

ALKUPERÄISTEN OHJEIDEN KÄÄNNÖS

SEINÄVALAISIN WFL800 |

WFL1600 | WFL2400

SISÄLLYS

Toimituksen sisältö	75
Merkkien selitykset.....	76
Tarkoituksenmukainen käyttö	76
Turvallisuusohjeet	76
Tuotteen osat.....	78
Asennus.....	78
Liitäntä.....	80
Valonheittimen asettaminen	81
Puhdistus	81
Tekniset tiedot	82
Hävittäminen.....	83
VASTUUVAPAUCLAUSEKKEET	83
TAKUU	83

TOIMITUKSEN SISÄLTÖ

1 x Seinävalaisin

1 x Käyttöohje

Pura tuote ensin pakkauksesta ja tarkista, että toimitus sisältää kaikki osat ja ne ovat moitteettomassa kunnossa. Älä käytä vaurioitunutta tuotetta.

Jos havaitset tuotteessa vaurioita, ota yhteyttä jälleenmyyjään.

MERKKIEN SELITYKSET

Noudata seuraavia merkkejä ja selityksiä, jotka löytyvät käyttöohjeesta, tuotteesta ja pakkauksesta.

 = Informaatio

Hyödyllisiä lisätietoja tuotteesta

 = Huomautus

Huomautus varoittaa kaikista mahdollisista vaurioista



 = Varoitus

Huomio – Vaara! Voi johtaa vakaviin vammoihin tai kuolemaan

 = Suojausluokka I

 = Sähköiskun vaara

 = Älä katso suoraan valonsäteeseen

 →  = Älä käytä tuotetta, jos lasi on rikki

TARKOITUKSEN MUKAINEN KÄYTTÖ

Tuote on tarkoitettu tuloporttien, läpikulkujen, piha-alueiden jne. valaisuun.

Tuote on tarkoitettu ainoastaan yksityiskäyttöön kotitalouksissa, ei kaupalliseen käyttöön.

TURVALLISUUSOHJEET



Lue ennen tuotteen käyttöönottoa koko käyttöohje huolellisesti läpi. Se sisältää tärkeää tietoa tuotteen käytöstä. Jos annat tuotteen eteenpäin, liitä käyttöohje tuotteen mukaan.

- Pidä tuote ja pakkaus lasten ulottumattomissa. Tuote ei ole leikkikalua. Lapsia tulee valvoa, jotta voidaan varmistaa, että he eivät leiki tuotteella.
- Hengenvaara sähköiskun vuoksi! Varmista aina, että virransyöttö tuotteeseen on katkaistu ennen asennusta tai muita tuotteeseen tehtäviä toimia. Varmista jakokaappi tahatonta kolmannen henkilön suorittamaa tuotteen päällekytkentää vastaan esim. varoituskilvellä.
- Tarkista aina, että verkkojännite vastaa tuotteen tyyppikilvessä mainittuja tietoja ennen tuotteen kytkemistä sähköverkkoon.

- Asennuspinnan ja -materiaalien täytyy kestää tuotteen paino. Epävarmoissa tilanteissa käänny ammattilaisen puoleen.
- Hengenvaara sähköiskun vuoksi! Huolehdi reikiä poratessasi, että et vaurioita vesi-, sähkö- tai muita johtoja. Käytä johdonhakulaitetta tähän tarkoitukseen.
- Tuote vastaa kotelointiluokkaa IP54: Vaaralliset ja herkäät osat on suojattu pölyltä. Roiskevesisuoja. Tuotetta ei saa upottaa veteen. IP-kotelointiluokka taataan vain asianmukaisesti asennetussa tuotteessa.
- Älä koske tuotteeseen märin tai kostein käsin.
- Huomioi, että liitäntäjohtoa ei ole vedetty liian kireälle tai se ei joudu kosketuksiin terävien esineiden, kemikaalien tai liuotusaineiden kanssa.
- Tarkista liitäntäjohto ja pistoke säännöllisesti vaurioiden varalta.
- Jos valaisimen johdon joustava kuori vaurioituu, sen saa vaihtaa uuteen vain valmistaja, tämän valtuuttama huoltopalvelu tai muu tehtävään pätevä henkilö vaaratilanteiden välttämiseksi.



Tuote vastaa suojausluokkaa I, joten se täytyy liittää suojajohtimeen.



Hengenvaara sähköiskun vuoksi! Hengenvaarallisen sähköiskun vaara asiaankuulumattoman käytön tai asennuksen vuoksi. Tuotteen saa liittää ainoastaan sähköalan ammattilainen!



Älä katso suoraan valonsäteeseen.

Älä valaise toisia henkilöitä suoraan kasvoihin. Pitkäkestoisessa valaisussa sinisen valon osuus voi vaurioittaa verkkokalvoa.



Turvalasia ei voi vaihtaa uuteen. Turvalasin vaurioituessa tuote täytyy hävittää.

- Jos tuotteessa on näkyviä vaurioita, vaaraton käyttö ei ole enää mahdollista. Jos tuote on vaurioitunut, se täytyy hävittää tai korjauttaa.
- Älä yritä itse korjata tuotetta! Korjauta tuote vain sähköalan ammattilaisella.
- Valaisimen valonlähdettä ei voi vaihtaa uuteen. Kun valonlähde on tullut elinkaarensa päähän, koko valaisin täytyy vaihtaa uuteen.

- Huomio! Liitäntään saa käyttää vain luokkaan H05RN-F 3G 1 mm² kuuluvaa tai korkeampitasoista liitäntäjohtoa.

TUOTTEEN OSAT

(katso sivu 2)

- | | |
|-------------------|---------------------------|
| 1 Ledit | 3 Liitäntäjohto |
| 2 Kiinnitysruuvit | 4 Kiinnitys-/asennussanka |

ASENNUS

- Katkaise jännitteensyöttö johtoon jakokaapista ja varmista se kolmansien henkilöiden suorittamaa tahatonta päällekytkemistä vastaan.
- Valitse tuotteelle sopiva asennusasento.

Huomautus:

Sangassa olevien kiinnitysreikien halkaisija on 5 mm. Valitse sopivat asennustarvikkeet.

Asennustarvikkeet eivät sisälly toimitukseen. Käyttöohje sisältää esimerkin asennuksesta 2 ruuvilla ja 2 tulpalla. Tarvittaessa asennuksessa voidaan käyttää muita asennustarvikkeita.

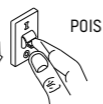

1.

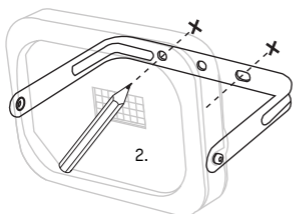

2.

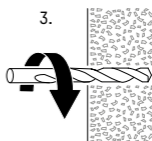

3.

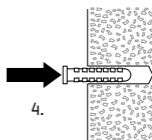

4.

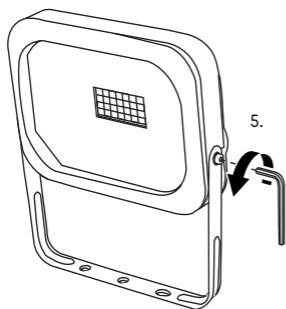

5.

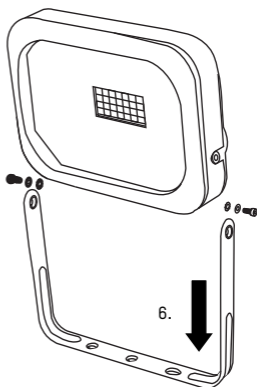

6.

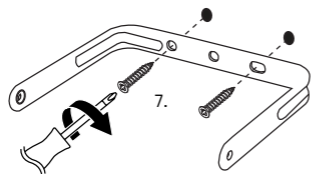

7.

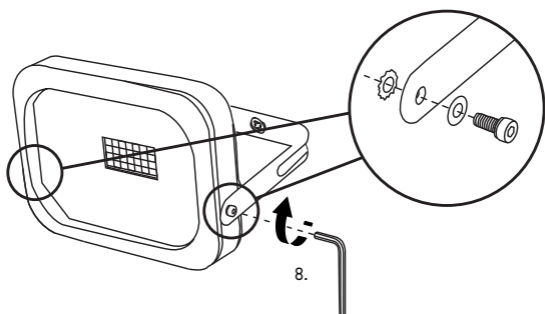

LIITÄNTÄ

- Liitä johtimet merkintöjen mukaisesti:

L	Vaihe	(ruskea)
	Maadoitus	(keltainen- vihreä)
N	Neutraali	(sininen)

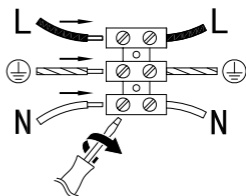

- Kytke jännitteensyöttö jälleen päälle.

i VALONHEITTIMEN ASETTAMINEN

- Löysää kiinnitysruuveja.

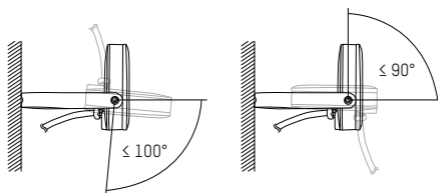

- Aseta valonheitin haluttuun kulmaan (-100° - +90°).

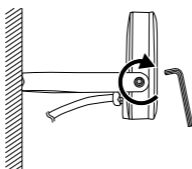

- Kiristä kiinnitysruuvit kuusiokoloavaimella.

i PUHDISTUS

- Katkaise jännitteensyöttö tuotteeseen jakokaapista ennen puhdistusta. Varmista tuote tahatonta päällekytkentää vastaan asettamalla varoituskilpi jakokaapin viereen.
- Puhdista tuote vain pehmeällä, kuivalla tai hieman kostutetulla liinalla (tarvittaessa miedolla astianpesuaineella). Älä käytä puhdistukseen hankaus- tai liuotinaineita.

TEKNISET TIEDOT

Malli	1600-0280: WFL800	1600-0281: WFL1600	1600-0282: WFL2400
Liitäntäjännite	220–240 V~, 50/60 Hz		
Teho	10 W	20 W	30 W
IP-luokitus	IP54 (roiskevesisuojaattu)		
Suojausluokka	I		
Valonlähde	LED		
Väriämpötila	5000 K		
Nimellinen valovirta	900 lm	1800 lm	2700 lm
Suurin projektiopinta	200 cm ²	385 cm ²	470 cm ²
Asennuspaikka	Sisä- ja ulkotilat		
Asennuskorkeus	enint. 3 m		
Käyttölämpötila t _a	–20 – +50 °C		
Lasin mitat (L x K x S) – n.	124 x 90 x 4 mm	177 x 127 x 4 mm	201 x 146 x 4 mm
Mitat sis. sangan (L x K x S) – n.	147 x 136 x 42 mm	202 x 190 x 34 mm	231 x 202 x 41 mm
Paino	0,44 kg	0,82 kg	1,15 kg

HÄVITTÄMINEN



Hävitä käytöstä poistettu valaisin lainsäädännön mukaisesti. Jäteastia-merkintä tarkoittaa, että EU-maissa sähkölaitteita ei saa hävittää talousjätteen mukana. Käytä hyväksesi kunnan järjestämiä palautus- ja keräysjärjestelmiä tai käänny jälleenmyyjän puoleen, jolta olet hankkinut tuotteen.

Näin täytät lailliset velvollisuutesi ja säästät ympäristöä.

VASTUUVAPAUSLAUSEKKEET

Käyttöohjeen sisältämät tiedot voidaan muuttaa ilman ennakoilmoitusta. ANSMANN ei ota vastuuta suorista, epäsuorista, satunnaisista tai muista vaurioista ja välillisistä vaurioista, jotka johtuvat tuotteen asiattomasta käytöstä tai käyttöohjeen noudattamatta jättämisestä. Tuotteen virheellisestä käytöstä emme ota vastuuta, ja kaikki takuuvaatimukset raukeavat.

TAKUU

Myönämme tuotteelle 10 vuoden takuun. Käyttöohjeen laiminlyömisestä johtuville vaurioille tuotteessa emme myönnä takuuta.

Tämä ei rajoita lakisääteistä takuuta.

Onze garantiebepalingen vindt u online op www.ansmann.de



www.tuv.com
ID 141906831



1600-0280
1600-0281



Tuote vastaa EU-direktiivien vaatimuksia.



www.tuv.com
ID 141906832



1600-0282

OVERSETTELSE AV OPPRINNELIGE ANVISNINGER

VEGGMONTERT FLOMBELYSNING

WFL800 | WFL1600 | WFL2400

INNHOLDSFORTEGNELSE

Leveranseinnhold	84
Tegnforklaring	85
Tiltenkt bruk	85
Sikkerhetsmerknader	85
Produktbeskrivelse	87
Montering.....	87
Tilkobling	89
Justere lyskaster	90
Rengjøring	90
Tekniske data	91
Avhending.....	92
ANSVARFRASKRIVELSE	92
GARANTIMERKNADER	92

LEVERANSEINNHold

1x Veggmontert flombelysning

1x Bruksanvisning

Pakk ut produktet og sjekk at leveransen er fullstendig og fri fra skader.

Ikke ta skadede produkter i bruk. Ta kontakt med forhandleren ved påviste skader på produktet.

TEGNFORKLARING

Vær oppmerksom på følgende tegn og ord som brukes i bruksanvisningen samt på produktet og forpakningen.

 = Informasjon

Nyttig tilleggsinformasjon om produktet

 = Merknad

Disse merknadene varstler om mulige skader alle slags typer



 = Advarsel

Forsiktig – fare! Kan føre til grove personskader eller dødsfall

 = Beskyttelsesklasse I

 = Fare for elektrisk støt

 = Ikke se inn i lysstrålen

 →  = Må ikke benyttes ved brudd på glass

 **TILTENKT BRUK**

Produktet er ment for belysning av innkjøringer, passasjer, friområder, osv.

Produktet er utelukkende ment for privat husholdningsbruk, og ikke for kommersiell bruk.

 **SIKKERHETSMERKNADER**



Les nøye gjennom hele bruksanvisningen før produktet tas i bruk. Denne inneholder viktige merknader om omgang med produktet.

Overlever bruksanvisningen også bruksanvisningen hvis produktet lånes borttil en tredjepart.

- Hold barn unna produktet og forpakningen. Produktet er ikke et leketøy. Hold øye med barn for å sikre at de ikke leker med produktet.
- Livsfare fra elektrisk støt! Vær alltid sikker på at strømtilførselen er brutt før montering eller annen håndtering av produktet. Sikre at sikringsboksen ikke slås på igjen av tredjeparter f.eks. med et varselskilt.
- Sjekk om nettspenningen tilsvarer den angitt på merkeskiltet til produktet før det slås på.

- Festeunderlaget og festematerialene må være i stand til å holde produktet sikkert på plass. Hør med en fagperson ved tvilstilfeller.
- Livsfare fra elektrisk støt! Pass på at ingen vann-, strøm- eller telefonledninger skades ved boring av hull. Bruk et ledersøkeapparat.
- Dette produktet samsvarer med beskyttelsesart IP54: Beskyttet mot inntrengning av støv i farlige og sensitive komponenter. Vannsprutbeskyttelse. Ikke senk produktet ned i vann. IP-beskyttelsesarten gjelder kun for produkter som er korrekt montert.
- Ikke grip produktet med våte eller fuktige hender.
- Pass på at ledningen ikke strammes til eller kommer i kontakt med skarpe gjenstander, kjemikalier eller løsemidler.
- Kontroller regelmessig at ledningen og stikkkontakten er fri for skader.
- For å unngå faremomenter, må en skadet ytre fleksibel ledning for dette lyset utelukkende byttes ut av produsenten eller tilsvarende fagpersonale.



Produktet samsvarer med beskyttelsesklasse I og må kobles til en jordingsleder.



Livsfare fra elektrisk støt! Utsiktet bruk, betjening eller montering medfører risiko for livsfarlig elektrisk støt. Produktet må utelukkende kobles til av elektrisk fagpersonale!



Ikke se rett inn i lysstrålen.

Ikke rett lyset mot ansiktet til andre personer. Slik eksponering over lengre tid kan føre til skader på netthinnen grunnet mengden av blått lys.



Sikkerhetsglasset kan ikke byttes ut. Ved skader på sikkerhetsglasset må produktet avhendes.

- En trygg bruk av produktet er ikke lenger mulig hvis det forekommer synlige skader på produktet. Hvis produktet har skader, må det avhendes eller repareres.
- Ikke reparer produktet på egenhånd! Reparasjoner må utføres av elektro-fagpersonale.
- Lyskilden til denne lampen kan ikke byttes ut. Når levetiden til lyskilden har utløpt, må hele lampen erstattes.

- Forsiktig! Kun tilkoblingskabler med kategorien H05RN-F 3G 1 mm² eller høyere må brukes for tilkobling.

PRODUKTBESKRIVELSE

(se side 2)

- | | |
|---------------|--------------------------|
| 1 LED-er | 3 Tilkoblingsledning |
| 2 Festeskruer | 4 Holde-/monteringsbøyle |

MONTERING

- Bryt strømforsyningen til kabelen direkte i sikringsboksen og sikre at denne ikke blir slått på igjen av tredjepersoner.
- Velg en egnet monteringsposisjon for produktet.

Merknader:

Festehullene til bøylene har en diameter på 5 mm. Velg et passende monteringsmaterieell.

Monteringsmaterieellet leveres ikke sammen med produktet. Denne bruksanvisningen bruker et monteringsseksempel med 2 skruer og 2 pluggar. Annet monteringsmaterieell kan brukes ved behov.

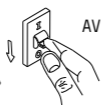

1.

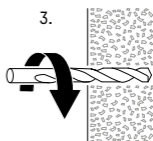

3.

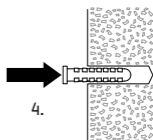

4.

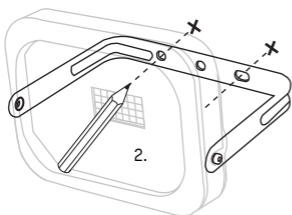

2.

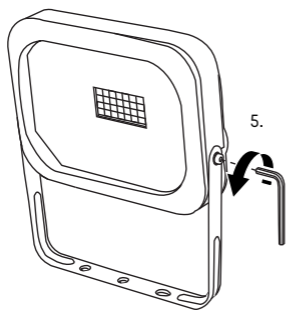

5.

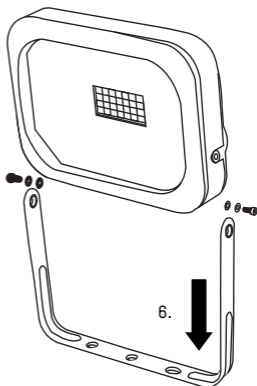

6.

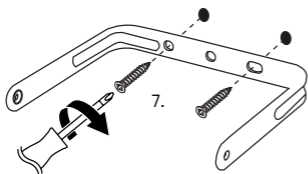

7.

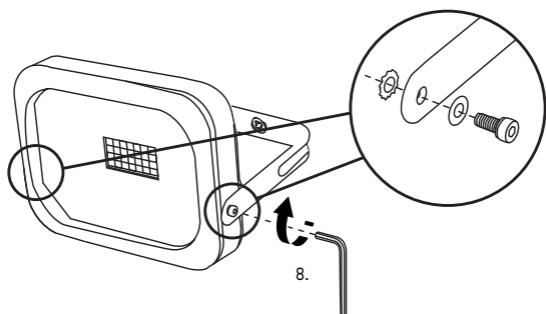

TILKOBLING

- Koble til lederne i samsvar med merkingene:

L Fase (brun)

 Jord (gul-grønn)

N Nøytral (blå)

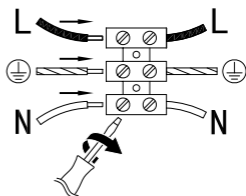

- Koble til strømforsyningen igjen.

i JUSTERE LYSKASTER

- Løsne festeskruene.

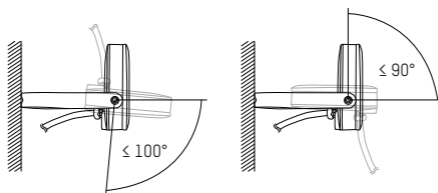

- Juster lyskasteren i ønsket vinkel (-100° til +90°).

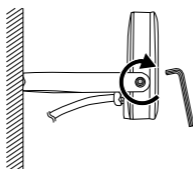

- Stram til festeskruene på nytt med en unbraconøkkel.

i RENGJØRING

- Slå alltid av strømforsyningen før rengjøring av produktet direkte i sikringsboksen. Sikre at produktet ikke slås på igjen ved uhell ved å sette opp et varselstilt ved sikringsboksen.
- Bruk utelukkende myke, tørre eller lett fuktige kluter (evt. med et mildt kjøkkenrengjøringsmiddel) for rengjøring. Aldri bruk skure- eller løsemidler for rengjøring.

TEKNISKE DATA

Modell	1600-0280: WFL800	1600-0281: WFL1600	1600-0282: WFL2400
Tilkoblingsspenning	220–240 V~, 50/60 Hz		
Effekt i Watt	10 W	20 W	30 W
IP-beskyttelsesart	IP54 (vannsprutbeskyttet)		
Beskyttelsesklasse	I		
Belysningstype	LED		
Fargetemperatur	5000 K		
Nominell belysningsstrøm	900 lm	1800 lm	2700 lm
Maksimalt projeksjonsområde	200 cm ²	385 cm ²	470 cm ²
Monteringssted	Innen- og utendørs		
Monteringshøyde	maks. 3 m		
Driftstemperatur t _a	-20 til +50 °C		
Mål glass (B x H x D) – ca.	124 x 90 x 4 mm	177 x 127 x 4 mm	201 x 146 x 4 mm
Mål med bølge (B x H x D) – ca.	147 x 136 x 42 mm	202 x 190 x 34 mm	231 x 202 x 41 mm
Vekt	0,44 kg	0,82 kg	1,15 kg

AVHENDING



Lamper som ikke kan brukes må avhendes i henhold til rettslige bestemmelser. Merket «søppelkasse» hentyder at elektroapparat ikke kan kastes sammen med normalt husholdningsavfall innenfor EU. Bruk tilbakeleverings- og innsamlingsystemene som finnes i den gjeldende regionen, eller ta kontakt med forhandleren som produktet ble kjøpt fra.

Dette vil oppfylle rettslige plikter og sikrer miljøvernsbidrag.

ANSVARFRASKRIVELSE

Opplysningene i denne bruksanvisningen kan endres uten forvarsel. ANSMANN pådrar seg intet ansvar for direkte, indirekte, tilfeldige eller andre typer skader eller følgeskader som oppstår grunnet utilsiktet bruk eller manglende oppmerksomhet for informasjonen gitt i denne bruksanvisningen. Vi påtar oss intet ansvar og innfrir ingen garantier eller garantikrav som gjøres på bakgrunn av feilaktig bruk av produktet.

GARANTIMERKNADER

Vi tilbyr en tiårs garanti på produktet. Ingen garantier vil innfris ved skader på produktet som følger av manglende oppmerksomhet gitt til bruksanvisningen.

Lovbestemte garantikrav kan ikke begrenses av disse bestemmelsene.

Du finner våre garantivilkår online på www.ansmann.de



www.tuv.com
ID 141906831



1600-0280
1600-0281

 Produktet oppfyller kravene til EUs retningslinjer.



www.tuv.com
ID 141906822



1600-0282

OVERSÆTTELSE AF DEN ORIGINALE
BRUGSANVISNING

VÆGPROJEKTØR

WFL800 | WFL1600 | WFL2400

INDHOLDSFORTEGNELSE

Leveringsomfang	93
Tegnforklaring	94
Forskriftsmæssig anvendelse	94
Sikkerhedsanvisninger	94
Produktbeskrivelse	96
Montering.....	96
Tilslutning.....	98
Indstilling af projektør	99
Rengøring	99
Tekniske data	100
Bortskaffelse.....	101
ANSVARFRASKRIVELSE	101
GARANTI.....	101

LEVERINGSOMFANG

1x Vægprojektør

1x Betjeningsvejledning

Produktet pakkes ud og undersøges for fuldstændighed og beskadigelser. Et beskadiget produkt må ikke tages i brug. Hvis der konstateres skader på produktet, skal du kontakte forhandleren.

TEGNFORKLARING

Vær opmærksom på følgende symboler og betegnelser, der anvendes i betjeningsvejledningen, på produktet og på emballagen.

 = Information

Nyttige ekstraoplysninger om produktet

 = Bemærk

Bemærkningen advarer om alle former for skader



 = Advarsel

Obs – Fare! Kan medføre svære kvæstelser eller dødsfald

 = Beskyttelsesklasse I

 = Fare for elektriske stød

 = Kig ikke ind i lysstrålen

 →  = Anvend ikke med ødelagt glas

FORSKRIFTSMÆSSIG ANVENDELSE

Produktet er beregnet til belysning af indkørsler, passager, udendørs områder etc.

Produktet er udelukkende beregnet til privat brug i husholdninger og ikke beregnet til kommercielt brug.

SIKKERHEDSANVISNINGER



Læs hele brugsvejledningen grundigt før produktet tages i brug. Dokumentet indeholder vigtig information for håndtering af produktet.

Hvis produktet overlades til tredjemand, skal betjeningsvejledningen medfølge.

- Hold produktet og emballagen uden for børns rækkevidde. Produktet er ikke et legetøj. Børn skal være under opsyn, så det sikres, at de ikke leger med produktet.
- Livsfare pga. elektrisk stød! Kontrollér altid at spændingsforsyningen er afbrudt inden montering eller andre arbejder på produktet. Eltavlen skal sikres mod utilsigtet tilkobling af andre, fx med et advarselsskilt.
- Kontrollér altid om netspændingen svarer til oplysningerne på produktets typeskilt før produktet tilsluttes.

- Fastgørelsesstedet og -materialerne skal være i stand til at holde produktet sikkert fast. I tvivlstilfælde kontaktes en fagmand.
- Livsfare pga. elektrisk stød! Ved boring af huller skal det sikres, at vand-, strøm- eller telefonledninger ikke beskadiges. Anvend en ledningssøger.
- Dette produkt opfylder tæthedsklasse IP54: Beskyttet mod indtrængning af støv til farlige og følsomme dele. Stænk-tæt. Produktet må ikke nedsænkes i vand.
IP-tæthedsklassen kan kun opretholdes ved korrekt montering af produktet.
- Tag ikke fat i produktet med snavsede eller fugtige hænder.
- Kontrollér at tilslutningsledningen ikke er spændt eller i kontakt med skarpe genstande, kemikalier eller opløsningsmidler.
- Kontroller regelmæssigt netstik og -kabel for skader.
- For at undgå farlige situationer, må en beskadiget udvendig og fleksibel ledning kun udskiftes af fabrikanten, dennes serviceafdeling eller en autoriseret el-installatør.



Produktet er klassificeret som beskyttelsesklasse I og skal derfor tilsluttes en jordledning.



Livsfare pga. elektrisk stød! Forkert anvendelse, betjening eller montering indebærer risiko for livsfarlige elektriske stød. Produktet må kun tilsluttes af en el-installatør!



Kig ikke direkte ind i lysstrålen.
Ret ikke lysstrålen mod andre personers ansigter. Hvis dette varer for længe, er der risiko for øjenskader på grund af lysets indhold af blå komponenter.



Sikkerhedsglasset kan ikke udskiftes. Ved beskadigelse af sikkerhedsglasset skal produktet kasseres.

- Hvis produktet har synlige skader er det ikke længere muligt at sikre ufarlig drift. Hvis produktet er beskadiget skal det kasseres eller repareres.
- Udfør ikke selv reparationer på produktet! Reparationer bør kun udføres af en autoriseret elektriker.

- Lyskilden i denne projektør kan ikke udskiftes. Når lyskildens levetid er forbi, skal hele projektøren udskiftes.
- Obs! Tilslutningen må kun udføres med et kabel i kategorien H05RN-F 3G 1 mm² eller en bedre kategori.

i PRODUKTBESKRIVELSE

(se side 2)

- | | | | |
|---|------------------|---|-------------------------|
| 1 | LEDs | 3 | Tilslutningskabel |
| 2 | Indstillingskrue | 4 | Holder-/monteringsbøjle |

i MONTERING

- Kablets spændingsforsyning afbrydes direkte i eltavlen og sikres mod genindkobling af andre.
- Vælg en egnet placering til produktet.

Bemærk:

Monteringshullerne i bøjlen har en diameter på 5 mm. Vælg det rigtige monteringsmateriale.

Monteringsmateriale medfølger ikke. I denne vejledning vises montering med 2 skrue og 2 rawplugs som eksempel. Der kan vælges andre monteringsmaterialer efter behov.

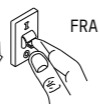

1.

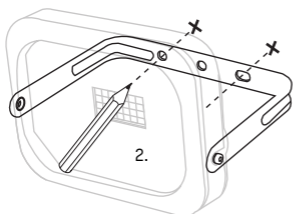

2.

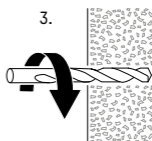

3.

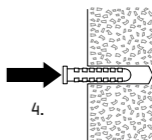

4.

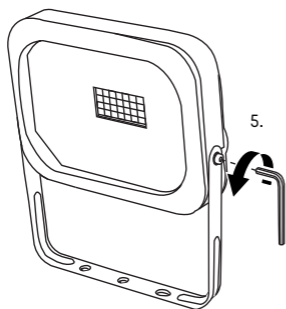

5.

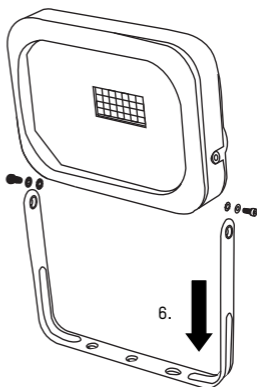

6.

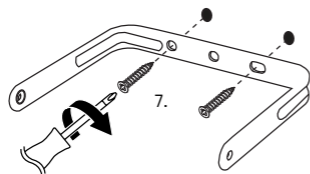

7.

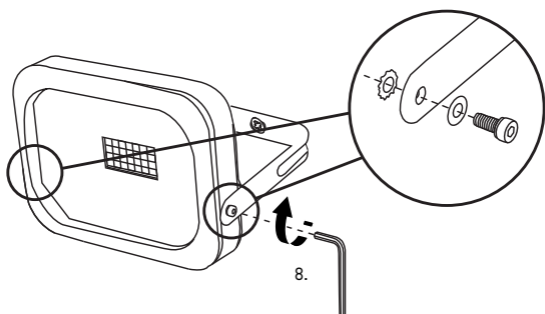

TILSLUTNING

- Tilslut lederne i henhold til markeringerne:

L	Fase	(brun)
	Jord	(gul-grøn)
N	Nul	(blå)

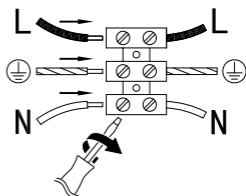

- Spændingsforsyningen tilkobles igen.

i INDSTILLING AF PROJEKTØR

- Indstillingskruerne løsnes.

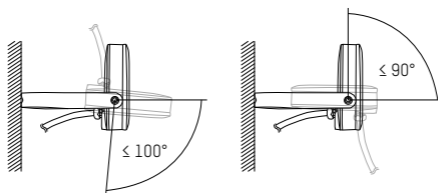

- Indstil den ønskede vinkel på projektøren (-100° til +90°).

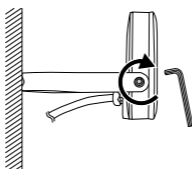

- Spænd indstillingskruerne fast igen med en unbrakonøgle.

i RENGØRING

- Før al rengøring skal produktet afbrydes fra spændingsforsyningen i eltavlen. Produktet skal sikres mod utilsigtet genindkobling ved at anbringe et advarselsskilt på eltavlen.
- Ved rengøring må der kun anvendes en blød, tør eller let fugtig klud (evt. med tilsætning af et mildt opvaskemiddel). Der må aldrig anvendes slibende medier eller opløsningsmidler.

TEKNISKE DATA

Model	1600-0280: WFL800	1600-0281: WFL1600	1600-0282: WFL2400
Tilslutningsspænding	220-240 V~, 50/60 Hz		
Effekt i watt	10 W	20 W	30 W
IP-tæthedsklasse	IP44 (stænktæt)		
Beskyttelsesklasse	I		
Lyskilde	LED		
Farvetemperatur	5000 K		
Nominal lysstrøm	900 lm	1800 lm	2700 lm
Maksimal projektiionsflade	200 cm ²	385 cm ²	470 cm ²
Monteringssted	Inden- og udendørs		
Monteringshøjde	maks. 3 m		
Driftstemperatur t _a	-20 til +50 °C		
Dimensioner, glas (B x H x D) – ca.	124 x	177 x	201 x
	90 x	127 x	146 x
	4 mm	4 mm	4 mm
Dimensioner med bøjle (B x H x D) – ca.	147 x	202 x	231 x
	136 x	190 x	202 x
	42 mm	34 mm	41 mm
Vægt	0,44 kg	0,82 kg	1,15 kg

BORTSKAFFELSE



Bortskaf den udtjente projektør i henhold til de lokale bestemmelser. Mærkningssymbolet "Skraldespand" betyder at elektrisk udstyr ikke må bortskaffes som almindeligt husholdningsaffald inden for EU. Anvend genbrugspladsen til bortskaffelse eller henvend dig til den forhandler, hvor produktet er købt.

Herved opfylder du de regionale bestemmelser og bidrager til miljøbeskyttelsen.

ANSVARFRASKRIVELSE

Informationerne i denne betjeningsvejledning kan ændres uden forudgående varsel. ANSMANN påtager sig ingen hæftelser for direkte, indirekte, uforudsete eller andre skader eller følgeskader, der opstår som følge af forkert håndtering eller som følge af, at informationerne i denne vejledning ikke følges. Ved forkert anvendelse af produktet påtager vi os intet ansvar og vi påtager os ingen garantier og garantikrav.

GARANTI

Vi tilbyder 10 års garanti på produktet. For skader, der skyldes at betjeningsvejledningen ikke følges, kan garantien ikke anvendes. Dine lovmæssige krav på garanti påvirkes ikke af dette.

Du finder vores garantibestemmelser online på www.ansmann.de



www.tuv.com
ID 141906831



1600-0280
1600-0281



Produktet opfylder kravene i EU-forordningerne.



www.tuv.com
ID 141906832



1600-0282

ANSMANN AG | Industriestrasse 10
97959 Assamstadt | Germany

Hotline: +49 (0) 6294 / 4204 3400
E-Mail: hotline@ansmann.de | www.ansmann.de