

LED Floodlight 12V-36V DC 20W 2800lm 5700K

Article number 145389

BAI LED Floodlight Low Voltage 20W 5700K 2800lm 12V-24V-28V-36V DC IP65 IK08 Alu housing black 120D 1.4m H05RN-F cable LED Floodlight

The Floodlight is also called a spotlight or construction lamp. The Led version consumes little power and lasts a long time so that they are more durable than the traditional predecessors. Can be mounted on both wall and ceiling. The housing is made of cast aluminum. As the name implies, the Low Voltage series is designed for low voltage applications (12V-36V). Comes with 140cm connection cable. Suitable for ambient temperatures from -20°C to +50°C. Consult specifications and warranty for installation.

[Click here for Eprel specifications](#)

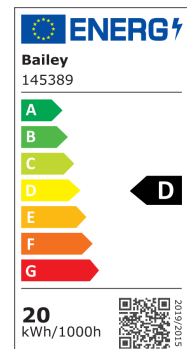
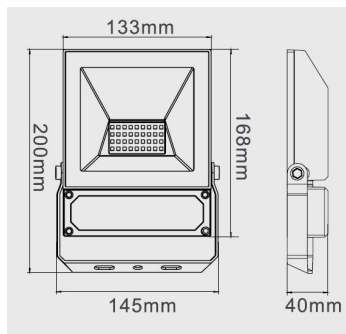

General ETIM properties

ETIM group	Luminaire
ETIM class	Downlight/spot/floodlight
Name	145389
Brand	Bailey
Productseries	LED Floodlight LV
Product type	Low voltage

ETIM specifications

Compatible with Amazon Alexa	No
Compatible with Google Assistant	No
Compatible with Apple HomeKit	No
Colour consistency (McAdam ellipse)	SDCM6
IFTTT support available	No
Covering of the luminaire with thermally insulating material possible	Yes
Suitable for workplace according to EN 12464-1	Yes
Photobiological safety according to EN 62471	RG1
Luminaire efficacy [lm/W]	140
Filament test according to IEC 60695-2-11	None
Emergency power supply integrated	No
Luminaire with limited surface temperature, sign "D"	Yes
Connection type	Other
Conductor cross section [mm ²]	1
Number of poles	2
Length [mm]	145
Height/depth [mm]	200
Width [mm]	40
Beam angle adjustable	No
Luminous flux adjustable	No
Colour temperature adjustable	No
Power factor	0.9
Rated luminous flux according to IEC 62722-2-1 [lm]	2800
Luminous flux [lm]	2800 - 2800
Colour rendering index CRI	70-79
Colour temperature [K]	5700 - 5700
Colour of light	White
Max. system power [W]	20
Suitable for lamp power [W]	20 - 20
Rated ambient temperature according to IEC62722-2-1 [°C]	-20 - 50
Protection class	III
Impact strength	IK08
Degree of protection (NEMA)	Other
Degree of protection (IP)	IP65
Constant light output (CLO)	No
Rated life time L80/B10 at 25 °C [h]	8500
Rated life time L70/B50 at 25 °C [h]	30000
Total harmonic distortion	20
Energy efficiency class	Other
Light outlet	Direct
Beam angle	Extreme wide beam >80°
Light sharing	Symmetric
Light distributor	Reflector
Reflector	Matt

No dim function	Yes
Dimming with push-button	No
Dimming Zigbee	No
Dimming Touch and Dim	No
Dimming Sine Wave Reduction	No
Dimming RF	No
Dimming programmable	No
Dimming phase cut-on	No
Dimming phase cut-off	No
Dimming mains voltage modulation	No
Dimming manufacturer's proprietary system	No
Dimming LineSwitch	No
Dimming GPRS	No
Dimming potentiometer (integrated)	No
Dimming DSI	No
Dimming DMX	No
Dimming DALI	No
Dimming DALI-2	No
Dimming 1-10 V	No
Dimming 0-10 V	No
Dimming depending on control gear	No
Exchangeable control gear	No
With control gear	Yes
Type of control gear	Low-loss ballast compensated
LED nominal current at constant current [mA]	460 - 460
Nominal voltage [V]	12 - 36
Voltage type	DC
Material cover	Glass transparent
Colour housing	Black
Surface protection	Powder coating
Material housing	Aluminium
Lamp holder	None
Suitable for number of lamps	1
With light source	Yes
Lamp type	LED not exchangeable
With light sensor	No
With movement sensor	No
Adjustability	Rotatable
Suitable for low voltage cable system	No
Suitable for clamp-mounting	No
Suitable for light-track mounting	No
Suitable for pedestal/floor mounting	Yes
Suitable for traverse mounting	No
Suitable for ceiling mounting	Yes
Suitable for suspended mounting	No
Suitable for wall mounting	Yes
Suitable for built-in mounting	No
Suitable for surface mounting	Yes

Complementary articles



92100032104

Connector TH400 Tee
2-way Tube 3P