

Grove Inventor Kit for micro:bit Project Guide

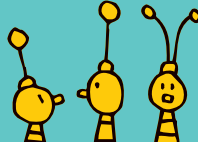
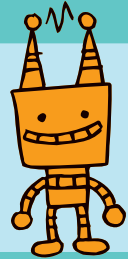
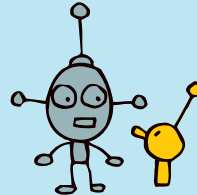
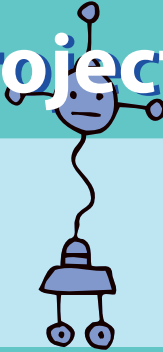
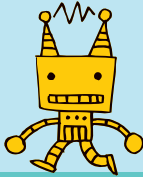
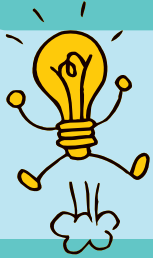

Big Inventions Start from Small Ideas

About Seeed

Diversified demands cannot be fully satisfied by mass production. The booming of open source hardware, 3D printing, crowd-funding and global logistics creates a evolutionary easy platform to hardware innovators. Products are becoming democratized, as some of the consumers now calling themselves makers.

Seeed is a hardware innovation platform for makers to grow inspirations into differentiating products. By working closely with technology providers of all scale, Seeed provides accessible technologies with quality, speed and supply chain knowledge. When prototypes are ready to iterate, Seeed helps productize 1 to 1,000 pcs using in-house engineering, supply chain management and agile manufacture forces. Seeed also team up with incubators, Chinese tech ecosystem, investors and distribution channels to portal Maker startups beyond.

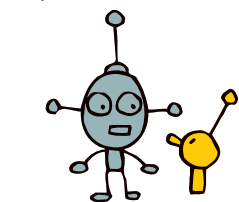

Copyright © 2008-2017 Seeed Technology Limited. All rights reserved.



Content

Product Introduction	1-2
How to program Grove on micro:bit	3-4
1.Control the Light	5-6
2.Sunshine micro:bit	7-8
3.LED Bar Control	9-10
4.Music Player	11-12
5.Gesture Recognition	13-14
6.Smart Guard	15-16
7.Shake Counter	17-18
8.Ultrasonic Meter	19-20
9.Rainbow on The Desk	21-22
10.Guardians of The Secrets in Your Bag	23-24
11.Guardians of The Secrets in Your Room	25-26
12.Magic Musician	27-28
How to update the Grove package	29-30





Product Introduction



Grove Starter Kit for micro:bit



5. Grove – Light Sensor V1.2

The light sensor is used to detect how much bright light is. This sensor is a photo-resistor which controls the current. Based on how much light the sensor detects, you could turn volume up or down, sound an alarm, or increase how fast an LED blinks!



6. Grove - WS2812 Waterproof LED Strip - 30 LEDs 1 meter

This is a RGB LED strip. RGB means each LED can change colors and You can control each LED separately to show different colors. It is also waterproof so you are free to use it outdoor without worrying about rain.



1. Grove Shield for micro:bit

Because micro:bit does not have the Grove interface, the Grove Shield for micro:bit adds 4 grove interfaces. This allows Grove modules to connect to the Grove shield and communicate with micro:bit.



2. Grove - Rotary Angle Sensor (P)

There is a 10kΩ potentiometer in the sensor, when you rotate the rotary knob, the value of this potentiometer will change. This causes the output signal to change linearly based on the angle (0°~300°). You can use this rotary knob to control volume, speed, or any other variable!



7. Grove – Gesture

This gesture sensor can recognize 9 different gestures: left, right, up, down, forwards, backwards, clockwise rotation, counter-clockwise rotation, and waving. You can use this sensor to build very fun applications such as using your gestures to switch songs or adjust the music volume.



8. Grove - 4-Digit Display

This display is very suitable for displaying numbers. It can be used to display time, distance, or display other sensor's values.



3. Grove – Speaker

The speaker can emit a variety of sounds such as a car horn, a doorbell, and an alarm. By changing the frequency of the input signal, you will get different sounds. You can also adjust the loudness by changing the angle of the cross screw.



4. Grove – Ultrasonic Ranger

This sensor sends out an ultrasonic sound. Based on when (or if) the sound returns to the sensor it can tell how far away an object is. This can be used to build projects that output different effects such as lights or sounds by changes in distance.



9. Grove - Red LED

This is a simple red LED. The maximum brightness can be controlled by the onboard potentiometer that integrates grove interface.

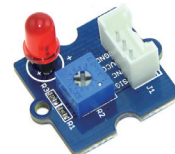

Note

Some projects with more than 1 Grove modules demands relatively more current, in order to make those Groves function better, we recommend using the USB port on Grove Shield for micro:bit to power the circuit.

How to program Grove on micro:bit

To program Grove modules with micro:bit, you will need to add the Grove PXT packages to your makecode environment.

Steps

1. Find the "Add Package" option at the bottom

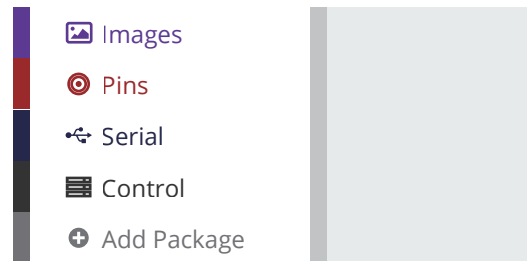

2. Now you can add Grove Packages by:

- 1) Searching the keyword 'Grove'
- 2) Simply enter project URL: github.com/seeed-studio/pxt-grove

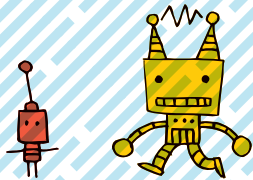

Add Package...

github.com/seeed-studio/pxt-grove

Grove

A Microsoft MakeCode package for Seeed Studio Grove Module

3. If you find "Grove" under "Math", congratulations! You have successfully added the Grove Package!

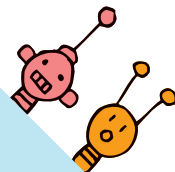
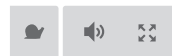
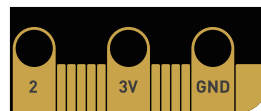

Loops

Logic

Variables

Math

Grove



1. Control the Light

Difficulty Level ★★★★★

Part List

- 1x Grove - Red LED
- 1x Grove Shield for micro:bit
- 1x micro:bit

Description

In this demo, you will learn how to use the 2 buttons on the micro:bit to turn the LED on and off.

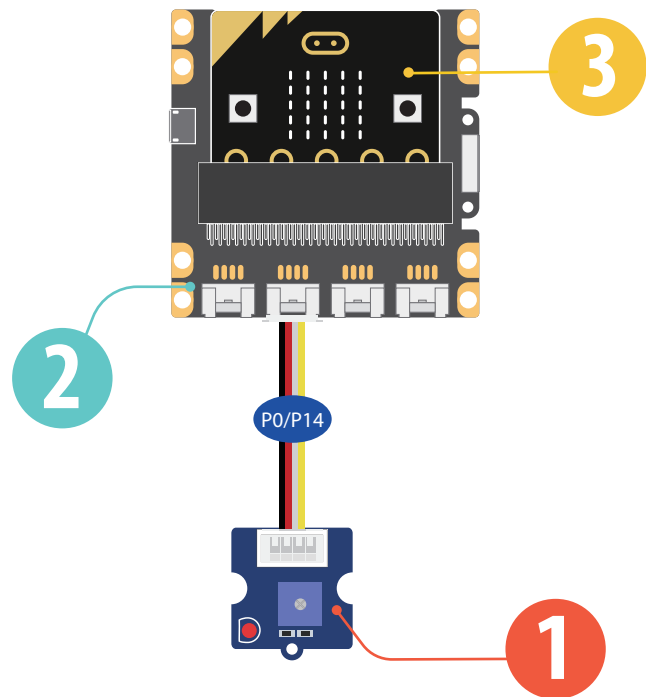
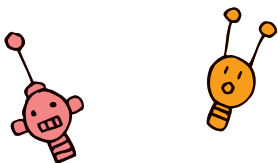

Steps

- 1 Add an input block for *on button A is pressed*, and add a pin block *digital write pin 0 to 1*.
- 2 Add an input block for *on button B is pressed*, and add a pin block *digital write pin 0 to 0*.
3. Hardware connection: Connect the Grove – Red LED to P0 port of Grove Shield for Micro:bit.
4. Click Download to transfer your code in your micro:bit!
5. Press button A and button B to see if the code works as expected.

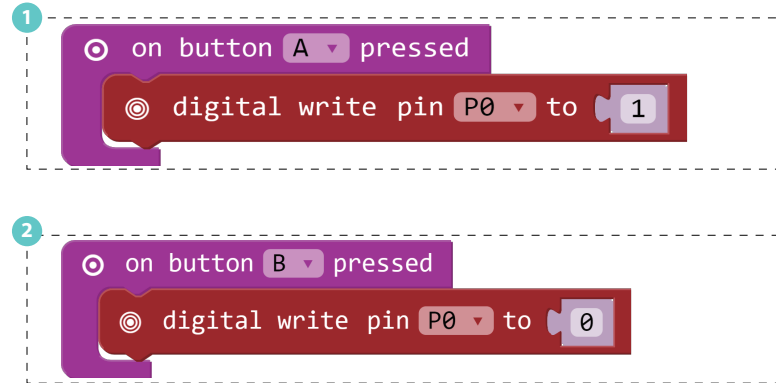

Add to this demo! Have button A turn the light on when pressed, and the off when pressed again! you.

2. Sunshine micro:bit

Difficulty Level ★★★★★

Part List

- 1x Grove - Light Sensor
- 1x Grove Shield for micro:bit
- 1x micro:bit

Description

In this demo you will learn how to use the LED bar graph on your micro:bit to show the current light level. The stronger the light is, the more LEDs will be turned on.

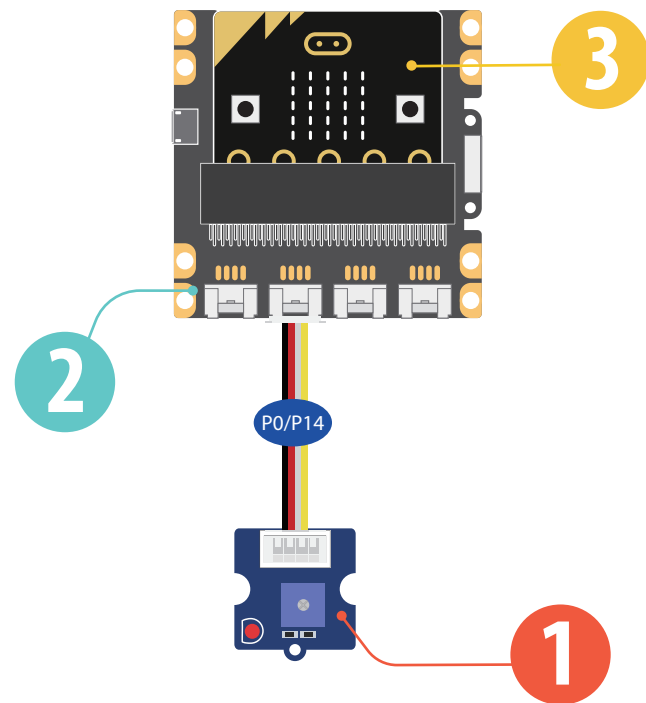
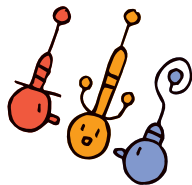

Steps

- 1 Add basic block *forever*, then add LED block *plot bar graph of....up to*, amend the block to be *plot bar graph of Light Sensor up to 255*.
- 2 Add basic block *pause(ms)*, change the value to "10".
3. Click Download to transfer your code in your micro:bit!
4. Put your hand over the light sensor to block the light, and see how the LEDs on micro:bit change.

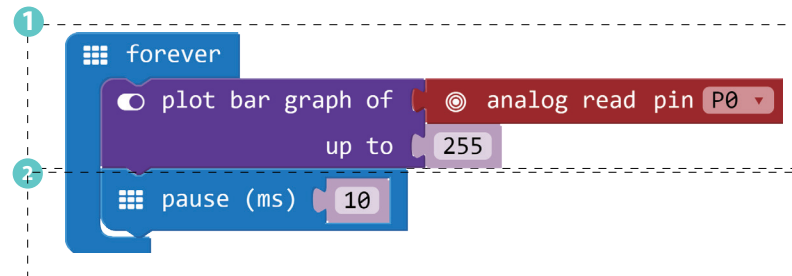

Try to change the "up to" value from 255 and see what happens



3. LED Bar Control

Difficulty Level ★★★★★

Part List

- 1x Grove - Rotary Angle Sensor(P)
- 1x Grove Shield for micro:bit
- 1x micro:bit

Description

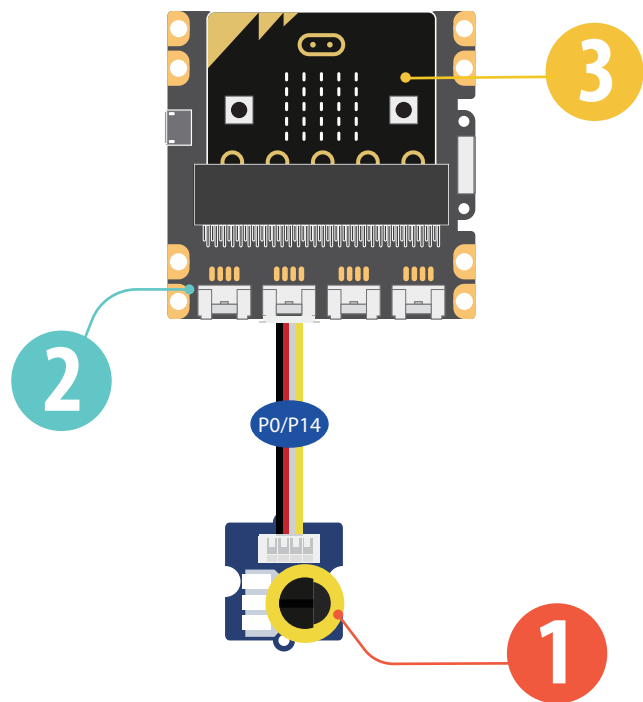
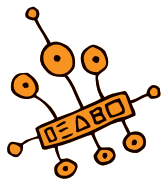

In this demo you will learn to control the LEDs on your micro:bit with the rotary angle sensor. The number of LEDs turned on will increase or decrease as you rotate the knob on the sensor.



Steps

- 1 Add basic block *forever*, then add Led block *plot bar graph of*. Replace the first value with pin block *analog read pin P0*, and change the second value to "1023". Add basic block *pause (ms) (100)*.
2. Hardware connection: Connect the rotary angle sensor to P0 port of micro:bit
3. Click Download to transfer your code in your micro:bit!
4. Rotate the knob on the rotary angle sensor and see the change of LED Bar.

```
forever loop
  plot bar graph of [analog read pin P0] up to 1023
  pause (ms) 100
```

 Try to change the "up to" value from 1023 to other numbers and see what will happen. Is there a difference compared to Demo 2? 

4. Music Player

Difficulty Level ★★★★★

Part List

- 1x Grove - Speaker
- 1x Grove Shield for micro:bit
- 1x micro:bit

Description

This demo will teach you how to use the 2 buttons on micro:bit to play music.

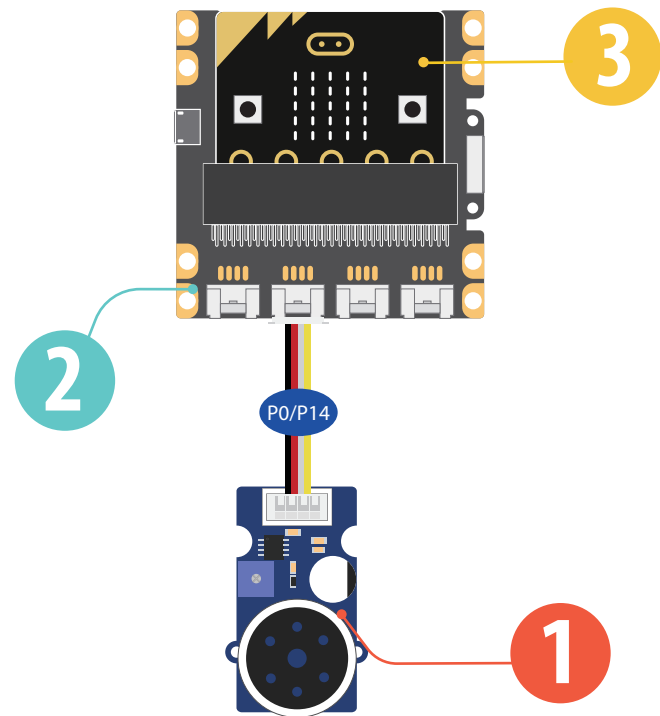
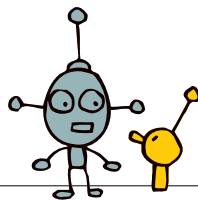

Steps

- 1 Add an input block for *on button A is pressed*, the speaker executes *play tone middle C for 1 beat*.
- 2 Add an input block for *on button B is pressed*, the speaker executes *start melody dadadum once*.
3. Click Download to transfer your code in your micro:bit!
4. Press button A or button B to play the sounds.

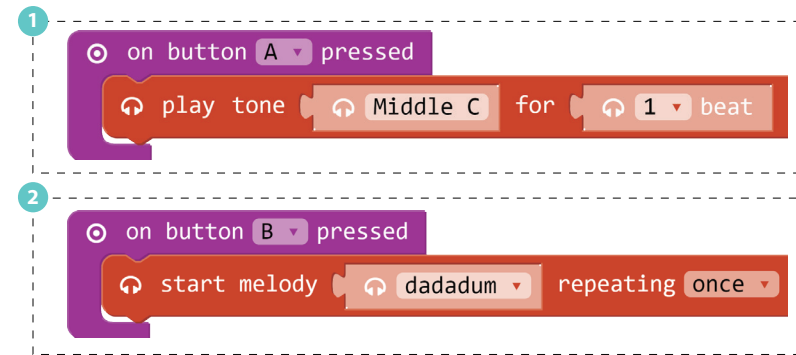

Try to use block *on button A+B pressed* and let the speaker play other sounds or melodies.



5. Gesture Recognition

Difficulty Level ★★☆☆

Part List

- 1x Grove - Gesture
- 1x Grove Shield for micro:bit
- 1x micro:bit

Description

The gesture sensor can recognize 9 different gestures, in this demo, you will learn how to display the recognized gesture name on micro:bit.

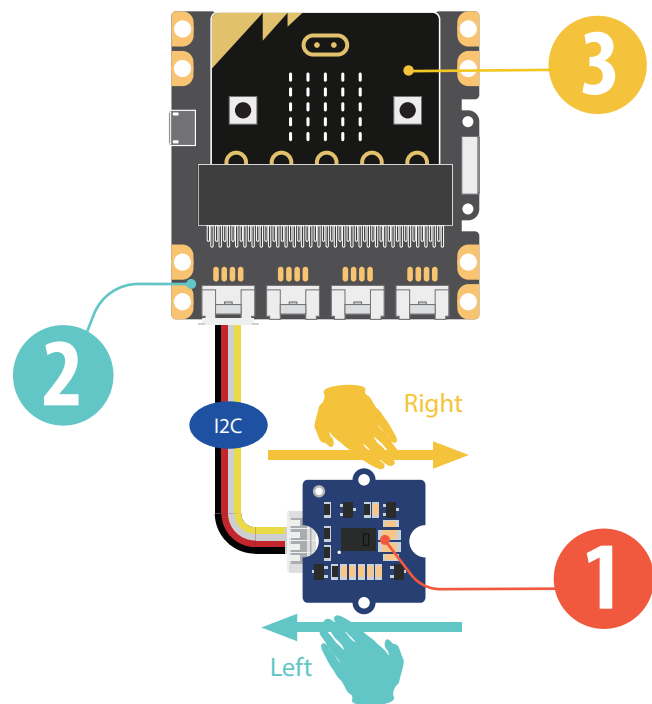

Steps

- 1 If you have added the 'Grove Package' successfully, add block *on Gesture Right*, then add basic block *show string*, amend the word to 'Right'.
 - 2 Add another block *on Gesture Left*, then add basic block *show string*, amend the word to 'Left'.
 - 3 Add another block *on Gesture*, choose "Clockwise". Then choose basic block *show icon*, then choose "smile face".
4. Hardware connection: Connect the Grove - Gesture to I2C port of Grove shield for micro:bit
5. Click Download to transfer your code in your micro:bit.
6. Use your hand to make different gesture in front of the gesture sensor and see if the micro:bit can show the exact gesture you are doing.

 *Try to show more gesture name or icon on the micro:bit.* 

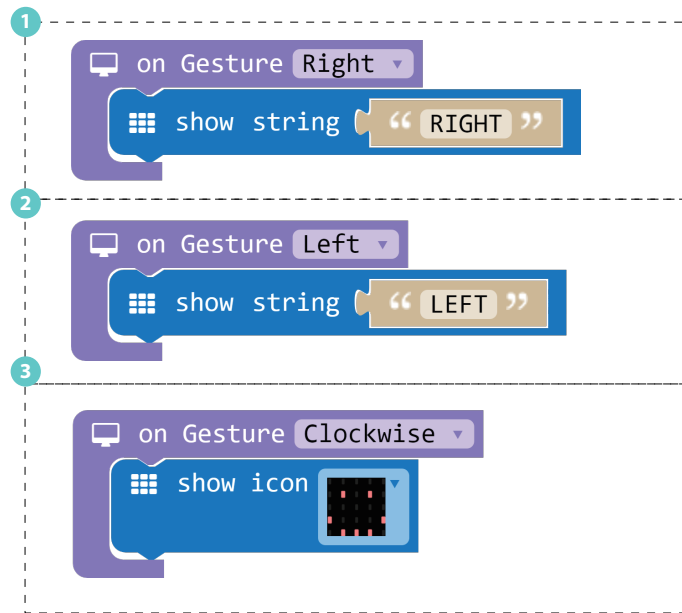

6. Smart Guard

Difficulty Level ★★★★★

Part List

- 1x Grove - Ultrasonic Ranger
- 1x Grove Shield for micro:bit
- 1x micro:bit

Description

The ultrasonic ranger is able to detect distance. In this demo, we will use the ultrasonic ranger to detect if the is too close. If something is too close the micro:bit will show a sad face on it.

! **Note:** This project requires high input voltage, please use the Grove Shield for micro:bit to power the circuit.

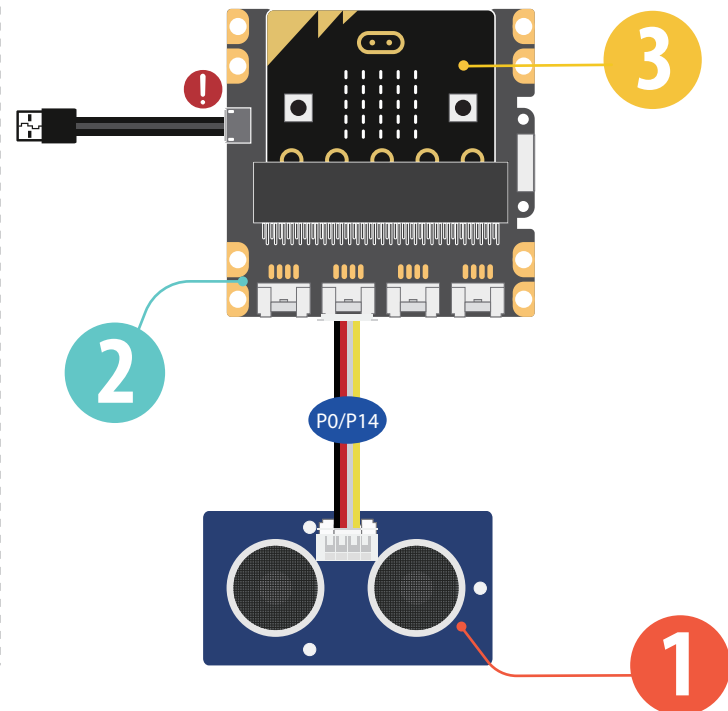
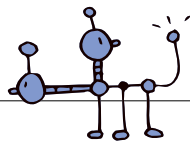

Project 6: Smart Guard

Steps

- 1 Add basic block *forever*, then add logic block *if...then...else...*
 - 2 For condition 'if', add logic block $0 \geq 0$
 - 3 If you have added the Grove Package successfully, replace the left '0' with Grove block *Ultrasonic Sensor (in cm) at P0*. Change another "0" to "10".
 - 4 For 'then', add basic block *show icon*, choose the 'happy face' icon.
 - 5 For "else", add basic block *show icon*, choose the 'sad face' icon.
 - 6 Add basic blocks *pause (ms) (100)*.
7. Hardware connection. Connect the Grove – Ultrasonic Sensor to P0 port of Grove shield for micro:bit.
8. Click Download to transfer your code in your micro:bit.
9. Move your hand up and down in front of the Ultrasonic Sensor, when your hand is less than 10cm close to the sensor, the micro:bit will show sad face.

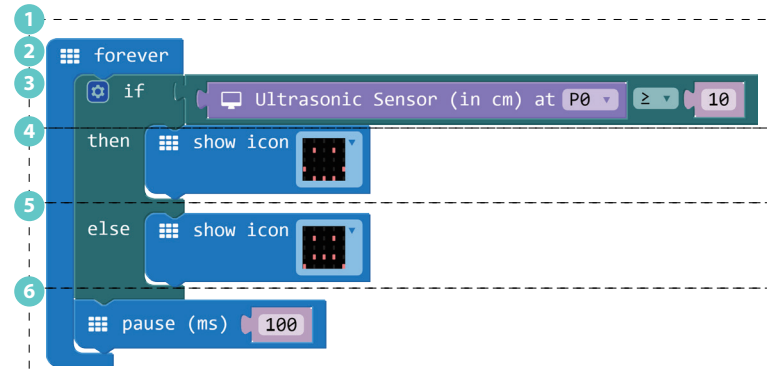

Try to change the warning distance or the warning icon. You may also place this smart guardian on your favorite toy to protect it! protect it.



7. Shake Counter

Difficulty Level ★★☆☆

Part List

- 1x Grove - 4-Digit Display
- 1x Grove Shield for micro:bit
- 1x micro:bit

Description

In this demo, every time you shake the micro:bit, it will increase the number displayed by 1.

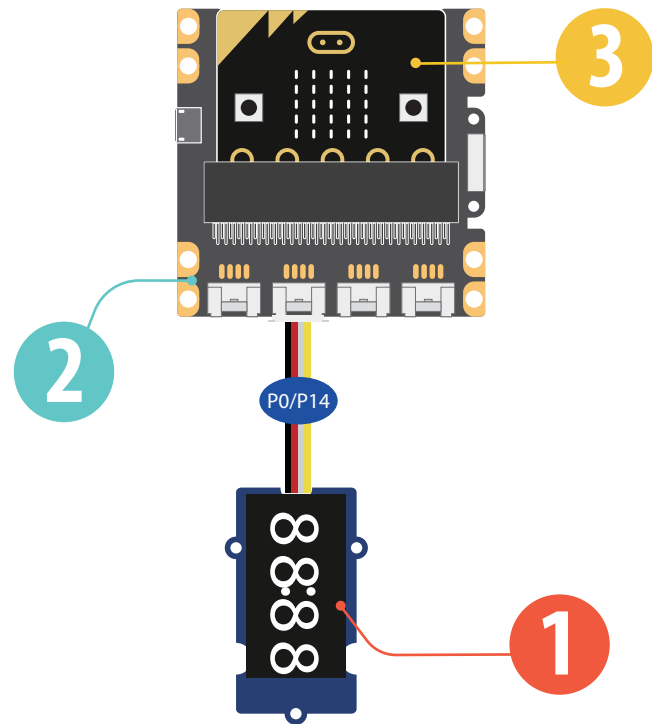
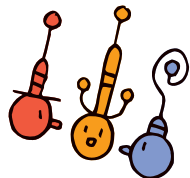

Steps

- 1 Add basic block *on start*, then add variable block *set item to 0*, rename 'item' to 'Display'. If you have added the Grove Package successfully, add block *4-Digit Display at (P0) and (P14)*.
- 2 Add input block *on shake*, then add variable block *change item by 1*, rename 'item' to 'N'.
- 3 Add block item *show number* from Grove Package, rename 'item' to 'Display', replace '0' with variable block 'N'.
- 4 Add basic block *pause (ms) (100)*.
5. Hardware connection: Connect the Grove – 4-Digital Display to P0 port of Grove shield for micro:bit.
6. Click Download to transfer your code in your micro:bit.
7. Shake the micro:bit and you will find the number raises by 1 every time you shake the board.

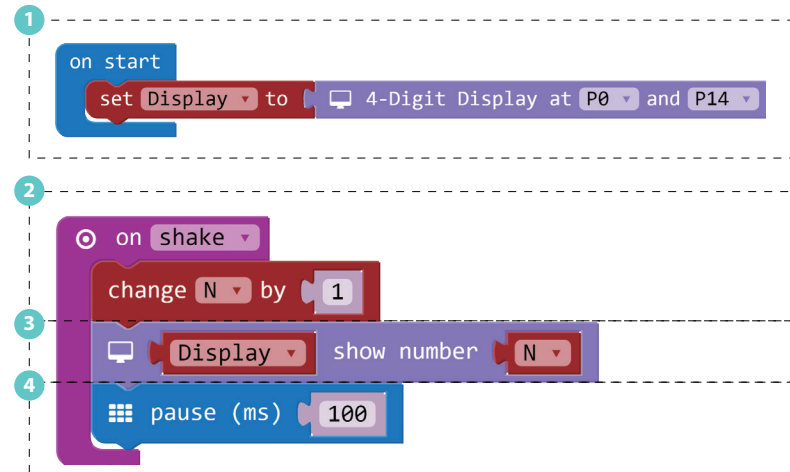

Use this demo to play a game with your friend. See who can get the highest score in 1 minute.



8. Ultrasonic Meter

Difficulty Level ★★☆☆

Part List

- 1x Grove - Ultrasonic Ranger
- 1x Grove - 4-Digit Display
- 1x Grove Shield for micro:bit
- 1x micro:bit

Description

In this demo, you will learn how to use the ultrasonic sensor to measure distance and show the value on a display.

Note: This project requires high input voltage, please use the Grove Shield for micro:bit to power the circuit.

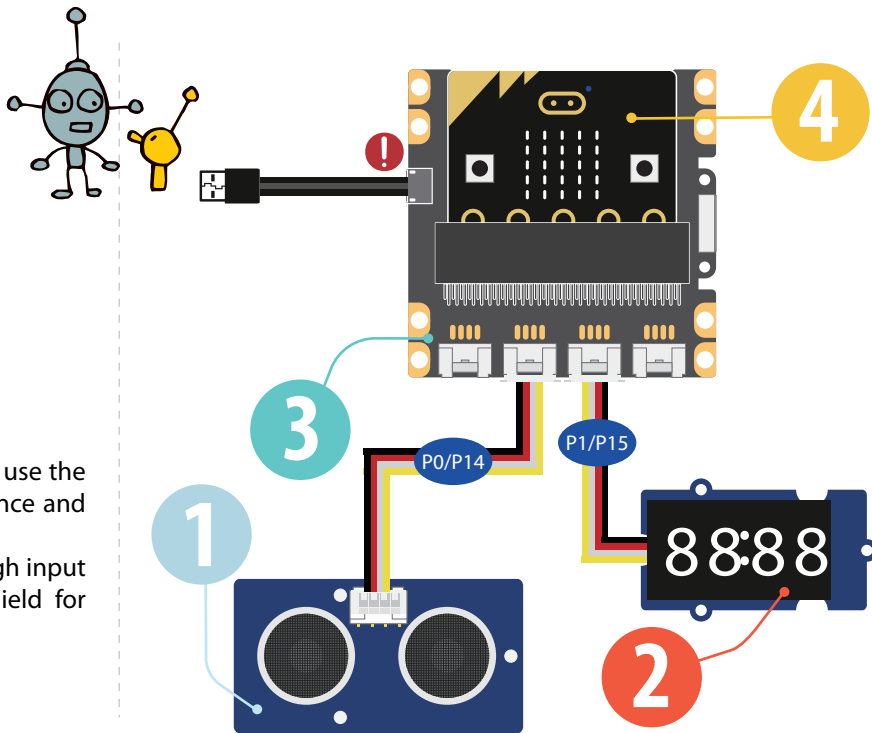

Project 8: Ultrasonic Meter

Steps

- 1 Add basic block *on start*, then add variable blocks *set item to 0*, rename 'items' to 'Display'. If you have successfully added the Grove package, replace "0" with Grove block *4-Digit Display at P1 and P15*.
- 2 Add basic block *forever*, then add Grove block item *show number 0*, rename 'item' to 'Display', replace '0' with Grove block *Ultrasonic Sensor (in cm) at P0*.
- 3 Add basic block *pause (ms) (100)*,

4. Click Download to transfer your code in micro:bit

5. Use your hand to move up and down on the ultrasonic ranger and read the value on the 4-Digit display.

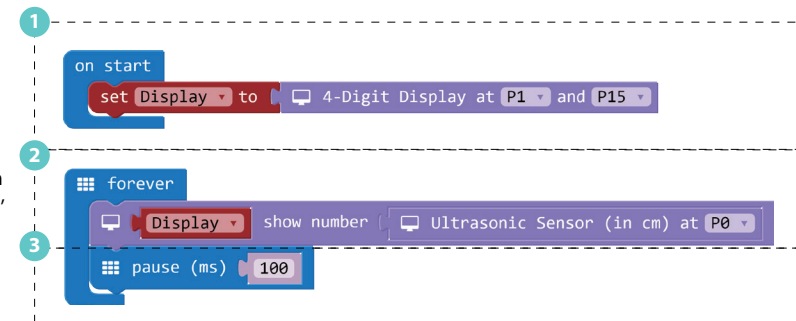

Try to use this creation to measure distance in your room.



9. Rainbow on The Desk

Difficulty Level ★★☆☆

Part List

- 1x Grove - Rotary Angle Sensor(P)
- 1x Grove - WS2812b
- 1x Grove Shield for micro:bit
- 1x micro:bit

Description

There are 30 LEDs on the LED strip, in this demo, you will learn to show rainbow color on the Led strip and use the Rotary Angle Sensor to let the rainbow flow on the Led strip.

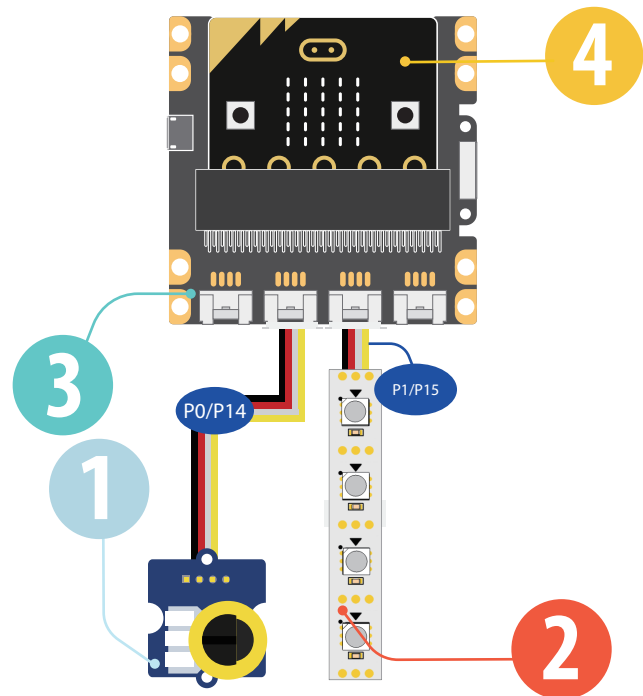
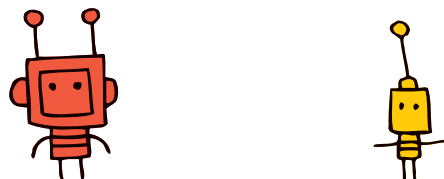

Steps

1. To use 'Grove - WS2812b LED strip', you need to add the '*neopixel*' package first.

2 Add basic block *on start*, then add variable block *set item to 0*, rename 'item' to 'Rainbow, replace '0' with block *Neopixel at pin (P1) with (30) leds as RGB*.

3 Add basic block *forever*, then add pixel block *show rainbow from 1 to* and pin block *map*, then add variable block *Rainbow* and pin block *analog read pin P0*, amend value in the blocks as below

4. Connect the hardware pieces as instructed.

5. Click Download to transfer your code in your micro:bit!

6. Rotate the knob on the Grove – Rotary Angle Sensor and see if the rainbow flows.

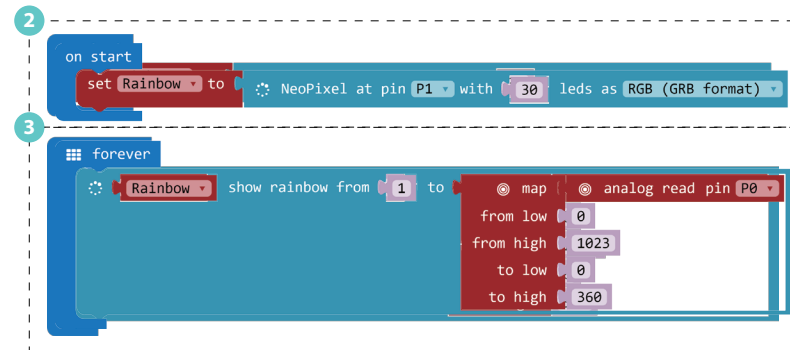

Try to change the numbers of LEDs to show the rainbow, or use the pin block map to have the rainbow flow more slowly.



10. Guardians of The Secrets in Your Bag

Difficulty Level ★★★★★

Part List

- 1x Grove - Speaker
- 1x Grove - Light Sensor
- 1x Grove - Red LED
- 1x Grove Shield for micro:bit
- 1x micro:bit

Description

In this demo, you will make a guardian to guard your secret stuff. If anyone opens the box, the guardian will flash a red light and sound an alarm!

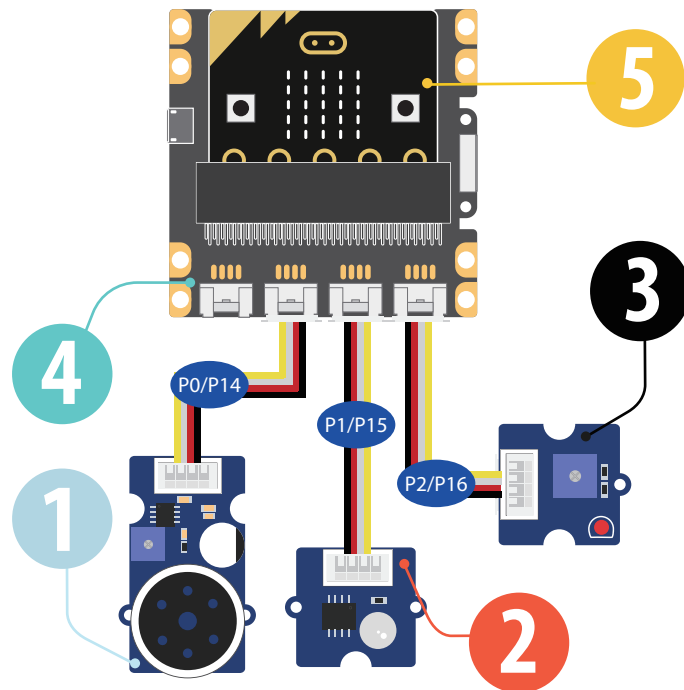

Steps

- 1 In the basic block *forever*, set a *variable* named 'Light Value' to *analog read pin P1*.
- 2 Now we add a logic block *if...then...else*, in this block we set the condition as if the 'Light Value' is greater than '100'
- 3 When the condition is triggered, we set the speaker to continuously *playing tone High C on P2(Pin2)*.
- 4 For 'else', add 2 pin blocks *digital write pin* and set pins to '0'. This will turn off the Led and speaker when the box is closed and no light is detected.
- 5 Add basic block *pause (ms) (100)*.
6. Hardware connection: Connect the speaker to P0 port, Grove – light sensor to P1 port, Grove - Led to P2 port,
7. Click Download to transfer your code in your micro:bit!
8. Open and close your secret box to see how it works.



Try to use this creation to protect your secrets in the drawer.

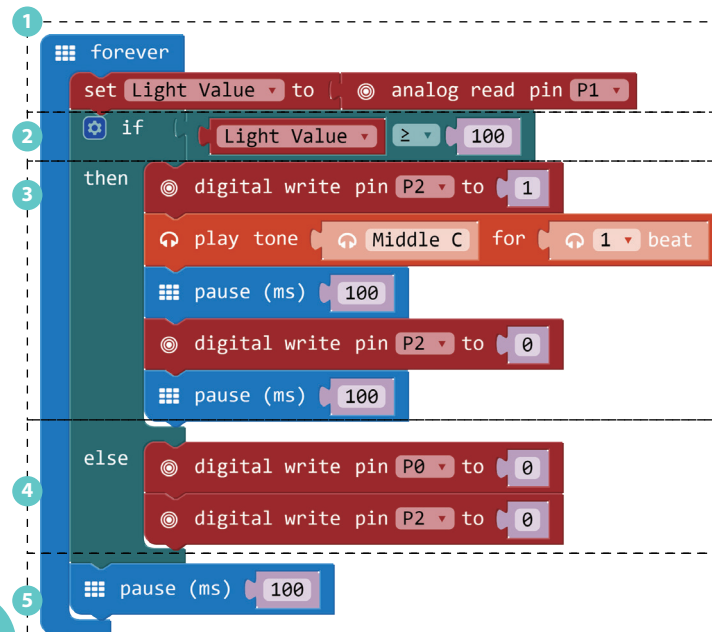

11. Guardians of The Secrets in Your Room

Difficulty Level ★★★★★

Part List

- 1x Grove - Speaker
- 1x Grove - Ultrasonic Ranger
- 1x Grove - Red LED
- 1x Grove Shield for micro:bit
- 1x micro:bit

Description

This demo will help guard your room. If anyone enters your room, the red LED will flash and the speaker will play an alarm. It is similar to the previous demo, except that this demo uses the ultrasonic sensor. If you have tried the demo, "smart guard", this one should be a piece of cake.

Note: This project requires high input voltage, please use the Grove Shield for micro:bit to power the circuit.

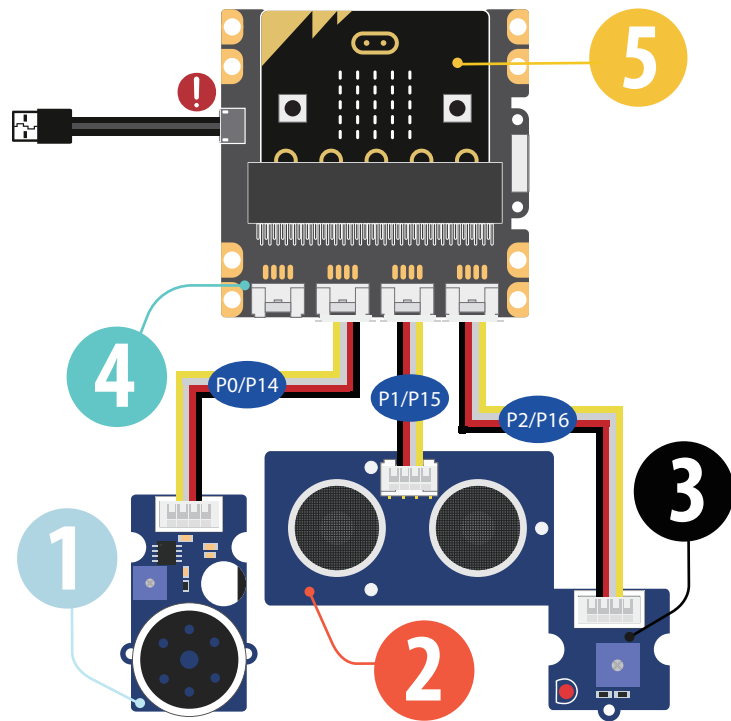
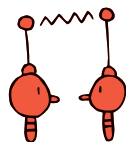

Steps

- 1 Add basic block *forever*, then add variable block *set item to* and grove block *Ultrasonic Sensor (in cm) at P1*, Rename "item" to "distance"
- 2 Add logic block *if...then...*. For condition "if", add logic block $0 \geq 0$, replace the first "0" with variable block *distance*, change another "0" to "60".
- 3 For 'then', add loop block *repeat 4 times*, the add a pin block *digital write pin P2 to 1* and a music block *play tone High C for 1 beat*. Add block *pause (ms) (100)*, then add a pin block *digital write pin P2 to 0* and a block *pause (ms) (100)* after it.
- 4 Add the last basic block *pause (ms) (100)*.
5. Hardware connection: connect the Grove modules as instructed in page 25.
6. Click Download to transfer your code in your micro:bit!
7. Move your hand up and down in front of the ultrasonic sensor and see if your guardian works well.

```
1 forever
2 set distance to Ultrasonic Sensor (in cm) at P2
3 if (distance <= 60)
  then
    repeat 4 times
      do
        digital write pin P2 to 1
        play tone High C for 1 beat
        pause (ms) 100
        digital write pin P2 to 0
        pause (ms) 100
4 pause (ms) 100
```



Try to use this creation to protect your room.



12. Magic Musician

Difficulty Level ★★★★★

Part List

- 1x Grove - Gesture
- 1x Grove - Speaker
- 4x Crocodile Clip
- 4x Bananas
- 1x Grove Shield for micro:bit
- 1x micro:bit

Description

This is a challenging level 4 demo; however, it is not as hard as it seems if you have tried the "Gesture Recognition" demo. This demo is very fun because you can use gesture and Bananas to create an instrument. Show this demo to your family and friends, they will be amazed by you!

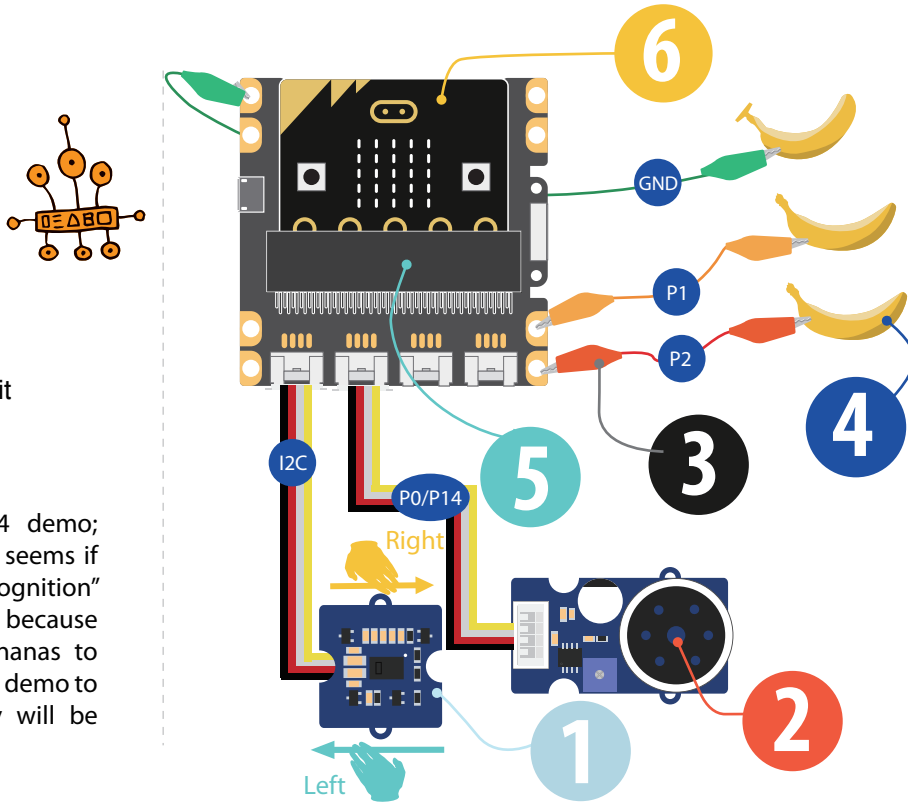

Steps

- 1 In the Grove Package, add *on Gesture Right* to trigger the speaker *start melody (dadadum) repeating (once)*.
 - 2 In the Grove Package, add *on Gesture Right* to trigger the speaker *start melody (entertainer) repeating (once)*.
 - 3 Add input block *on pin P1 pressed*, then add music block *start melody (birthday) repeating once*, or choose any melody you like except the two you have used in step 1 and 2.
 - 4 Add another input block *on pin P2 pressed*, then add music block *start melody (wedding) repeating once*, or choose the another melody you like.
5. Connect the hardware pieces as instructed in page 27.
6. Click Download to transfer your code in your micro:bit!
7. For gesture control, use your hand to move left and right above the gesture sensor, you will hear different music.
8. For banana control, use one of your hand to touch the banana that is connected to GND, use another hand to touch the banana on P1 or P2, you will hear different music.

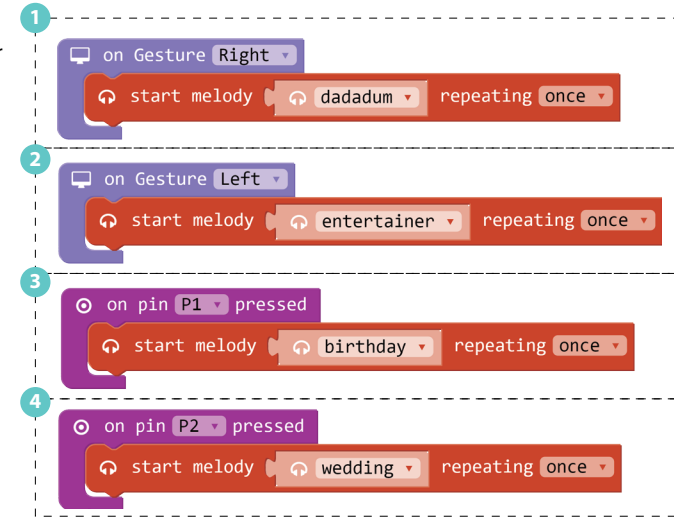

Try to use more bananas or gestures to play more sounds and melodies you like. Maybe make a band with a friend!



How to update the Grove package

Just like the driver of your computer, the Grove package also needs updating. So how to update the Grove package on your side? Here are 2 ways.

The first way is starting a new project, then you will find that there is no Grove package in the console, Add Grove package using the way showed in page 3 to 4 and you will have the latest Grove package.

However if you drag an old hex file which uses old Grove package into the new project, the old package will override the new one. In this case, you can update the package by following below steps.

1. Click the gear icon on the right top.

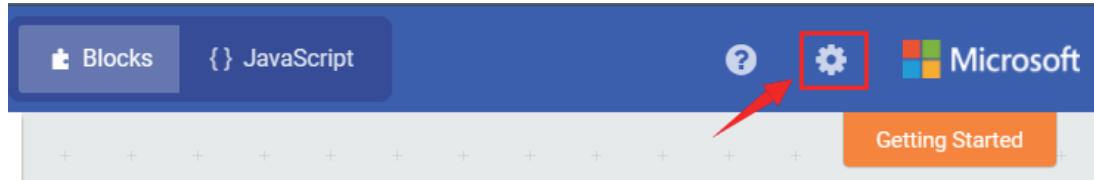

2. Choose "Project Settings"

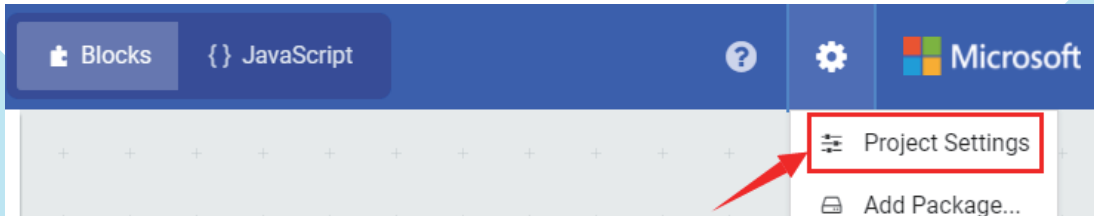

3. Find the "Explorer" under micro:bit. Click it.

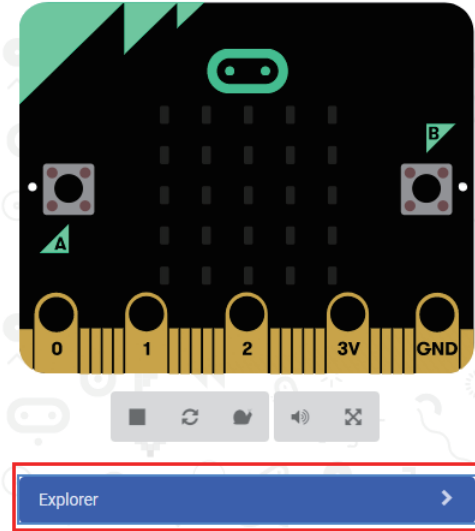

4. Scroll down and find the Grove package, click the refresh icon.

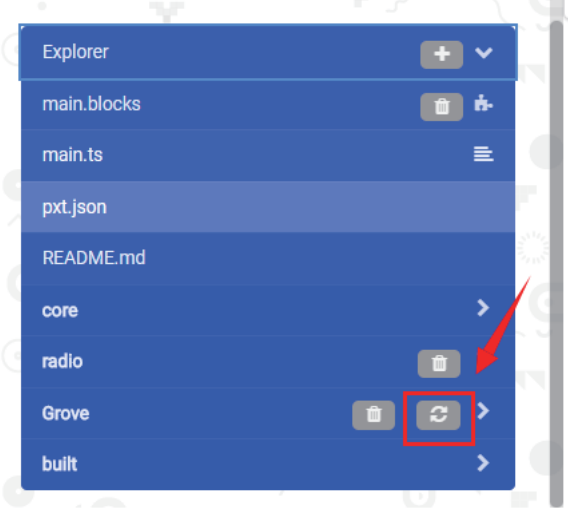



Grow the difference