



# SECTION 1

SOCKET COMPATIBLE AND  
FLANGE MOUNTED RELAYS  
1 TO 30 AMPERES



# SOCKET COMPATIBLE & FLANGE MOUNT RELAYS

## RELAY SERIES



## FEATURES

- 0.187 QUICK CONNECT/ SOLDER PLUG-IN OR PRINTED CIRCUIT TERMINALS
- FLAG INDICATOR
- L.E.D. STATUS LAMP
- PUSH BUTTON
- FINGER GRIP COVER
- I.D. TAG/WRITE LABEL
- OPTIONAL FLANGE AND DIN ADAPTERS
- UL LISTED WHEN USED WITH 70-781D-1 SOCKET

- 0.100 SOLDER PLUG-IN TERMINALS
- HERMETICALLY SEALED VACUUM BAKED AND DRY NITROGEN FILLED
- GRAY LACQUER FINISH OVER STEEL ENCLOSURE
- MEETS UL STANDARD FOR CLASS 1 DIVISION 2 HAZARDOUS LOCATIONS
- UL LISTED WHEN USED WITH 70-461-1 SOCKET

- 0.100 QUICK CONNECT/ SOLDER PLUG-IN OR PRINTED CIRCUIT TERMINALS
- FLAG INDICATOR
- L.E.D. STATUS LAMP
- PUSH BUTTON WITH LOCK DOWN DOOR
- FINGER GRIP COVER
- I.D. TAG/WRITE LABEL OPTIONAL
- FLANGE AND DIN ADAPTERS AVAILABLE
- UL LISTED WHEN USED WITH 70-461-1 SOCKET

## CONTACT DATA

CONTACT CONFIGURATION:

SPDT

4PDT

DPDT, 4PDT

CONTACT MATERIAL:

SILVER ALLOY,  
GOLD FLASHED

SILVER, GOLD OVERLAY (1 AMP)  
SILVER, GOLD FLASHED (3 AMPS)  
SILVER ALLOY (5 AMPS)

SILVER, GOLD OVERLAY (3 AMPS)  
SILVER, GOLD FLASHED (3 AMPS)  
SILVER ALLOY, GOLD FLASHED (10 AMPS)

MAX. CONTACT RATING:

15 AMPS, 110/120 VAC 50/60Hz  
15 AMPS, 28 VDC  
12 AMPS, 220/277 VAC 50/60Hz

1 AMP, BIFURCATED  
120/240 VAC/28 VDC  
3 AMPS, 120/240 VAC/28 VDC  
5 AMPS, 120/240 VAC/28 VDC

3 AMPS, BIFURCATED,  
120/240VAC/28 VDC  
3 AMPS, 120/240 VAC/28 VDC  
10 AMPS, 120/240 VAC/28 VDC  
8 AMPS, 220/277 VAC 50/60Hz

## COIL DATA

STANDARD VOLTAGE

AC:  
DC:

6,12, 24,120, 220/230, 240 VAC  
6,12, 24, 48,110 VDC

6,12, 24,120, 240 VAC  
6,12, 24, 48,110 VDC

6,12, 24,120, 220/230, 240 VAC  
6,12, 24, 48,110 VDC

NOMINAL COIL POWER  
VA: (VAC)  
WATTS: (VDC)

0.9 VA  
0.7 WATTS

1.2 VA  
0.9 WATTS

1.2 VA  
0.9 WATTS

INSULATION SYSTEM PER  
UL STANDARD 1446

CLASS "B" (130°C)

CLASS "B" (130°C)

CLASS "B" (130°C)

## GENERAL DATA

AMBIENT TEMPERATURE  
OPERATING:

-40°C TO +70°C

-45°C TO +70°C

-40°C TO +70°C

STORAGE:

-40°C TO +100°C

-60°C TO +130°C

-40°C TO +105°C

DIELECTRIC STRENGTH:  
(COIL TO FRAME)

1500 V rms

1240 V rms

1500 V rms

LIFE EXPECTANCY

ELECTRICAL:  
MECHANICAL:

150,000 OPERATIONS  
10,000,000 OPERATIONS

100,000 OPERATIONS  
10,000,000 OPERATIONS

200,000 OPERATIONS  
10,000,000 OPERATIONS

## MATING SOCKETS

SEE SECTION 8

70-781D-1, 70-781F-1, 70-781T-1

70-461-1, 70-378-1, 70-379-1

70-461-1, 70-378-1, 70-379-1

PAGE 18, 19

PAGE 14, 15

PAGE 14, 15

## AGENCY APPROVALS



## PAGE NUMBER

1...1

PAGE 9 - 10

PAGE 11 - 12

PAGE 13 - 15

# SOCKET COMPATIBLE & FLANGE MOUNT RELAYS



# SOCKET COMPATIBLE & FLANGE MOUNT RELAYS

## RELAY SERIES



## FEATURES

- 0.100 OR 0.187 QUICK CONNECT/ SOLDER PLUG-IN OR PRINTED CIRCUIT TERMINALS
- OPPOSITE POLARITY ARC BARRIER BETWEEN ADJACENT POLES
- UL LISTED WHEN USED WITH 70-461-1 OR 70-459-1 SOCKETS

- 8 & 11 PIN OCTAL BASE
- FLAG INDICATOR
- L.E.D. STATUS LAMP
- PUSH BUTTON WITH LOCK DOWN DOOR
- FINGER GRIP COVER
- I. D. TAG/WRITE LABEL
- UL LISTED WHEN USED WITH 70-464-1, 70-465-1, 70-750D8-1 OR 70-750D11-1 SOCKETS

- 8 & 11 PIN OCTAL BASE
- BLOWOUT MAGNET FOR DC SWITCHING TO 150 VDC
- UL LISTED WHEN USED WITH 70-464-1 OR 70-465-1 SOCKETS

## CONTACT DATA

CONTACT CONFIGURATION:

**SPDT, DPDT, 4PDT**

**DPDT, 3PDT**

**SPDT, DPDT, 3PDT**

CONTACT MATERIAL:

SILVER, GOLD OVERLAY (3 AMP)  
SILVER, GOLD FLASHED (3 AMP)  
SILVER ALLOY, GOLD FLASHED (5 & 15 AMP)

SILVER ALLOY,  
GOLD FLASHED

SILVER ALLOY,  
GOLD FLASHED

MAX. CONTACT RATING:

**4PDT:** 3 AMPS, BIFURCATED  
120/240 VAC/30 VDC,  
3 AMPS, 120 VAC/30 VDC  
5 AMPS, 120/240 VAC/30 VDC  
**DPDT:** 15 AMPS,  
**SPDT:** 15 AMPS, 120/240 VAC/30 VDC

12 AMPS, 120/240 VAC  
12 AMPS, 28 VDC

**SPDT:** 12 AMPS, 120/240VAC, 10 AMPS, 28 VDC  
**DPDT:** 12 AMPS, 120 VAC, 10 AMPS, 240 VAC,  
10 AMP, 28 VDC  
**3PDT:** 10 AMPS, 120/240 VAC, 10 AMPS, 28 VDC  
**DPDT:** 3 AMPS, 150VDC  
WITH BLOWOUT MAGNET

## COIL DATA

STANDARD VOLTAGE

AC:

6, 12, 24, 120, 240 VAC

DC:

6, 12, 24, 48, 110 VDC

6, 12, 24, 120, 220/230, 240 VAC

6, 12, 24, 48, 110 VDC

24, 120, 240 VAC

12, 24 VDC

NOMINAL COIL POWER

VA: (VAC)

WATTS: (VDC)

1.2 VA

0.9 TO 1.1 WATTS

2 TO 3.55 VA

1.4 WATTS

2 TO 2.75 VA

1.2 WATTS

INSULATION SYSTEM PER  
UL STANDARD 1446

CLASS "B" (130°C)

CLASS "B" (130°C)

## GENERAL DATA

AMBIENT TEMPERATURE

OPERATING:

-40°C TO +70°C

-30°C TO +50°C (AC)

-30°C TO +65°C (DC)

-30°C TO +100°C

-30°C TO +55°C (AC)

-30°C TO +70°C (DC)

-45°C TO +105°C

STORAGE:

-40°C TO +100°C

DIELECTRIC STRENGTH:

(COIL TO FRAME)

1500 V rms

2500 V rms

1500 V rms

LIFE EXPECTANCY

ELECTRICAL:

MECHANICAL:

200,000 OPERATIONS  
10,000,000 OPERATIONS

200,000 OPERATIONS  
5,000,000 OPERATIONS

100,000 OPERATIONS  
10,000,000 OPERATIONS

## MATING SOCKETS

SEE SECTION 8

**70-459-1, 70-461-1, 70-401-1 70-402-1,  
70-378-1, 70-379-1, 70-782D-1**

PAGE 13, 14, 15

**70-464-1, 70-465-1, 70-750D8-1,  
70-750D11-1, 70-169-1, 70-170-1**

PAGE 7, 8, 9, 10, 11, 12

**70-464-1, 70-465-1, 70-750D8-1,  
70-750D11-1, 70-169-1, 70-170-1**

PAGE 7, 8, 9, 10, 11, 12

## AGENCY APPROVALS



## PAGE NUMBER

1...3

PAGE 21 - 24

PAGE 25 - 26

PAGE 27 - 28



**788**

ISO 9002  
QS 9000

**L W H**  
2.28 x 1.375 x 1.410

- 0.187 QUICK CONNECT/ SOLDER PLUG-IN OR PRINTED CIRCUIT TERMINALS
- FLAG INDICATOR
- PUSH BUTTON WITH LOCK DOWN DOOR
- FINGER GRIP COVER
- I.D. TAG/WRITE LABEL
- UL LISTED WHEN USED WITH 70-463-1 SOCKET



**A283**

ISO 9002  
QS 9000

**L W H**  
1.90 x 1.53 x 1.40

- BASE PLUG-IN OR FLANGE MOUNT
- 0.187 QUICK CONNECT/ SOLDER PLUG-IN OR PRINTED CIRCUIT TERMINALS
- UL LISTED WHEN USED WITH 70-463-1 SOCKET



**A283 FOR DC SWITCHING**

















ISO 9002  
QS 9000

**L W H**  
1.90 x 1.53 x 1.40

- 0.187 QUICK CONNECT/ SOLDER PLUG-IN
- A283 BUILT FOR DC SWITCHING TO 150 VDC
- UL LISTED WHEN USED WITH 70-463-1 SOCKET

<b>DPDT, 3PDT</b>	<b>SPDT, DPDT, 3PDT</b>	<b>DPDT, SPST-NO-DM</b>
SILVER ALLOY, GOLD FLASHED	SILVER ALLOY, GOLD FLASHED	SILVER ALLOY, GOLD FLASHED
12 AMPS, 110/120 VAC 50/60Hz 12 AMPS, 28 VDC	15 AMPS, 120/240 VAC 50/60Hz 10 AMPS, 28 VDC	15 AMPS, 120/240 VAC 50/60Hz 10 AMPS, 28 VDC <b>DPDT:</b> 3 AMPS, 150 VDC <b>SPST-NO-DM:</b> 10 AMPS, 150 VDC
6,12,24,120, 220/230, 240 VAC 6,12, 24, 48,110 VDC	24,120, 240 VAC 12, 24,110 VDC	120 VAC 12, 24,110 VDC
2 TO 3.55 VA 1.4 WATTS	2.275 VA 1.2 WATTS	2.275 VA 1.2 WATTS
CLASS "B" (130°C)	CLASS "B" (130°C)	CLASS "B" (130°C)
-30°C TO +50°C (AC) -30°C TO +65°C (DC) -30°C TO +100°C	-30°C TO +50°C (AC) -30°C TO +65°C (DC) -30°C TO +100°C	-30°C TO +50°C (AC) -30°C TO +65°C (DC) -30°C TO +100°C
2500 V rms	2000 V rms	2000 V rms
200,000 OPERATIONS 5,000,000 OPERATIONS	100,000 OPERATIONS 5,000,000 OPERATIONS	100,000 OPERATIONS 5,000,000 OPERATIONS
<b>70-463-1, 70-124-1,70-124-2, 70-178-1, 70-178-2</b> <small>PAGE 16, 17</small>	<b>70-463-1, 70-124-1, 70-124-2, 70-178-1, 70-178-2</b> <small>PAGE 16, 17</small>	<b>70-463-1, 70-124-1, 70-124-2 , 70-178-1, 70-178-2</b> <small>PAGE 16, 17</small>
   	   	   

# SOCKET COMPATIBLE & FLANGE MOUNT RELAYS

RELAY SERIES	 <b>388J</b>  ISO 9002 QS 9000 L W H 1.90 x 1.53 x 1.40	 <b>388V</b>  ISO 9002 QS 9000 L W H 1.90 x 1.53 x 1.40	 <b>389F</b>  ISO 9002 QS 9000 L W H 1.90 x 1.53 x 1.40
<b>FEATURES</b>	<ul style="list-style-type: none"> <li>0.187 QUICK CONNECT / SOLDER PLUG-IN TERMINALS</li> <li>FLAG INDICATOR</li> <li>PUSH BUTTON</li> <li>FINGER GRIP COVER</li> <li>UL LISTED WHEN USED WITH 70-463-1 SOCKET</li> </ul>	<ul style="list-style-type: none"> <li>0.187 QUICK CONNECT/ SOLDER PLUG-IN TERMINALS</li> <li>PUSH BUTTON</li> <li>HIGH VOLTAGE SWITCHING</li> <li>MEETS 8 mm EUROPEAN SPACING REQUIREMENTS 3 MILLIMETER CONTACT GAP</li> <li>UL LISTED WHEN USED WITH 70-463-1 SOCKET</li> </ul>	<ul style="list-style-type: none"> <li>FLANGE MOUNT, 0.250 QUICK CONNECT/ SOLDER TERMINALS</li> <li>SWITCHING UP TO 25 AMPS</li> <li>FLAG INDICATOR</li> <li>PUSH BUTTON</li> </ul>
<b>CONTACT DATA</b>			
CONTACT CONFIGURATION:	<b>DPDT, 3PDT</b>	<b>DPST-NO, 3PST-NO</b>	<b>DPDT</b>
CONTACT MATERIAL:	SILVER ALLOY, GOLD FLASHED	SILVER ALLOY, GOLD FLASHED	SILVER ALLOY, GOLD FLASHED
MAX. CONTACT RATING:	<b>DPDT:</b> 20 AMPS, 300 VAC 50/60Hz 20 AMPS, 28 VDC <b>3PDT:</b> 16 AMPS, 250 VAC 50/60Hz 16 AMPS, 28 VDC	15 AMPS, 120/240 VAC 50/60Hz 15 AMPS, 28 VDC	25 AMPS, 300 VAC 50/60Hz 13 AMPS, 28 VDC
<b>COIL DATA</b>			
STANDARD VOLTAGE			
AC:	24, 120, 240 VAC	24, 120, 240 VAC	24, 120, 240 VAC
DC:	12, 24 VDC	12, 24 VDC	12, 24 VDC
NOMINAL COIL POWER VA: (VAC)	2 TO 3.5 VA	1 TO 1.2 VA	2 TO 3.5 VA
WATTS: (VDC)	1.44 WATTS	3.0 WATTS	1.44 WATTS
INSULATION SYSTEM PER UL STANDARD 1446	CLASS "B" (130°C)	CLASS "B" (130°C)	CLASS "B" (130°C)
<b>GENERAL DATA</b>			
AMBIENT TEMPERATURE OPERATING:	-30°C TO +50°C (AC) -30°C TO +65°C (DC)	-30°C TO +50°C (AC) -30°C TO +65°C (DC)	-30°C TO +50°C (AC) -30°C TO +65°C (DC)
STORAGE:	-30°C TO +100°C	-30°C TO +100°C	-30°C TO +100°C
DIELECTRIC STRENGTH: (COIL TO FRAME)	2200 V rms	2000 V rms	2200 V rms
LIFE EXPECTANCY ELECTRICAL:	100,000 OPERATIONS	100,000 OPERATIONS	100,000 OPERATIONS
MECHANICAL:	5,000,000 OPERATIONS	5,000,000 OPERATIONS	5,000,000 OPERATIONS
<b>MATING SOCKETS</b> SEE SECTION 8	<b>70-463-1, 70-124-1, 70-124-2, 70-178-1, 70-178-2</b> PAGE 16, 17	<b>70-463-1, 70-124-1, 70-124-2, 70-178-1, 70-178-2</b> PAGE 16, 17	—
<b>AGENCY APPROVALS</b>	   	   	  
<b>PAGE NUMBER</b> 1...5	PAGE 35 - 36	PAGE 37 - 38	PAGE 39 - 41

# SOCKET COMPATIBLE & FLANGE MOUNT RELAYS



389

ISO 9002  
QS 9000









300

ISO 9002  
QS 9000



9A

<p>L W H 1.90 x 1.53 x 1.40</p>	<p>L W H 1.90 x 1.53 x 1.40</p>	<p>L W H 1.980 x 1.08 x 1.10</p>
<ul style="list-style-type: none"> <li>● FLANGE MOUNT, 0.250 QUICK CONNECT/ SOLDER TERMINALS</li> <li>● SWITCHING UP TO 30 AMPS</li> </ul>	<ul style="list-style-type: none"> <li>● FLANGE MOUNT, 0.250 QUICK CONNECT / SOLDER OR PRINTED CIRCUIT TERMINALS</li> <li>● 2 MILLIMETER CONTACT GAPS</li> <li>● ARC BARRIER BETWEEN CONTACTS</li> <li>● OPTIONAL BLOWOUT MAGNET FOR HIGH VOLTAGE SWITCHING</li> <li>● OPTIONAL DIN RAIL CASE</li> </ul>	<ul style="list-style-type: none"> <li>● EPOXY SEALED IMMERSION CLEANABLE WITH TAPE SEAL</li> <li>● PRINTED CIRCUIT BOARD OR FLANGE MOUNT STYLES</li> <li>● CLASS "F" INSULATION SYSTEM</li> <li>● 0.250 SPADE TERMINALS ACCEPT INSULATED 0.250 QUICK CONNECT TERMINALS. &amp; 0.187 COIL QUICK CONNECT TERMINALS.</li> <li>● OPTIONAL DIN RAIL ADAPTER AVAILABLE</li> </ul>
<p><b>SPDT, DPDT, 3PDT, SPST-NO-DM SPST-NO-NC-DM-DB</b></p>	<p><b>DPDT-SPDT-NO-NC-DM-DB</b></p>	<p><b>SPST-NO &amp; SPDT</b></p>
<p>SILVER ALLOY, GOLD FLASHED</p>	<p>SILVER ALLOY, GOLD FLASHED</p>	<p>SILVER ALLOY</p>
<p><b>SPST-DM, SPST-DB-DM:</b> 30 AMPS, 300 VAC 50/60Hz, 30 AMPS, 28 VDC <b>SPDT, DPDT:</b> 25 AMPS, 300 VAC 50/60Hz, 13 AMPS, 28 VDC <b>3PDT:</b> 20 AMPS, 300 VAC, 50/60Hz, 13 AMPS, 28 VDC</p>	<p>30 AMPS, 120/240/277 VAC 50/60Hz 30 AMPS, 28 VDC, 15 AMPS, 600 VAC <b>DPDT:</b> 5 AMPS, 150 VDC <b>SPDT-DB-DM:</b> 10 AMPS, 150 VDC</p>	<p><b>SPST-NO:</b> 30 AMPS, 240 VAC, 20 AMPS, 28 VDC <b>SPDT:</b> 30 AMPS, 240 VAC 20 AMPS, 28 VDC(NO), 15 AMPS, 240 VAC, 10 AMPS, 28 VDC (NC),</p>
<p>24,120, 240 VAC 12, 24 VDC</p>	<p>6, 12, 24, 120, 240 VAC 6,12, 24, 48, 110/125, 220/225 VDC</p>	<p>5, 12, 24, 48 &amp; 110 VDC</p>
<p>2 TO 3.5 VA 1.44 WATTS</p>	<p>3.0 VA 2.0 WATTS</p>	<p>0.95 VA 2.8 WATTS MAX.</p>
<p>CLASS "B" (130°C)</p>	<p>CLASS "B" (130°C) CLASS "F" (155°C) AVAILABLE</p>	
<p>-30°C TO +50°C (AC) -30°C TO +65°C (DC) -30°C TO +100°C</p>	<p>-30°C TO +50°C (AC) -30°C TO +60°C (DC) -40°C TO +105°C</p>	<p>- 55°C TO +85°C - 55°C TO +130°C</p>
<p>2200 V rms</p>	<p>4000 V rms</p>	<p>2500 V rms</p>
<p>100,000 OPERATIONS 5,000,000 OPERATIONS</p>	<p>100,000 OPERATIONS 10,000,000 OPERATIONS</p>	<p>100,000 OPERATIONS 10,000,000 OPERATIONS</p>
<p>—</p>	<p>—</p>	<p><b>OPTIONAL DIN ADAPTER 16-9A DIN-1</b></p>
<p>   UL Recognized File No. E43641 168986</p>	<p>  UL Recognized File No. E13224 50758</p>	<p> UL Recognized File No. E43641</p>

**RELAY SERIES**



**FEATURES**

- EPOXY SEALED IMMERSION CLEANABLE WITH TAPE SEAL
- PRINTED CIRCUIT BOARD OR FLANGE MOUNT STYLES
- CLASS "F" INSULATION SYSTEM.
- 0.250 SPADE TERMINALS ACCEPT 0.250 QUICK CONNECT TERMINALS
- OPTIONAL DIN RAIL ADAPTER AVAILABLE

- 0.100 SOLDER PLUG-IN OR PRINTED CIRCUIT TERMINALS
- UP TO 6 POLES SWITCHING PLUG-IN STYLES HAVE 3-48 UNC GROUND STUDS

- 12 OR 14 PIN PLUG-IN WITH LOCKING CLIP
- ENCAPSULATED COIL
- WIDE RANGE OF CONTACT CONFIGURATIONS
- WIDE CHOICE OF OPTIONS
- UL LISTED WHEN USED WITH 27390 OR 33377 SOCKET

**CONTACT DATA**

CONTACT CONFIGURATION:

**DPST-NO. & DPDT**

**DPDT THRU 8PDT**

**VARIOUS**

CONTACT MATERIAL:

SILVER ALLOY

SILVER GOLD OVERLAY

SILVER ALLOY,  
GOLD DIFFUSED

MAX. CONTACT RATING:

**DPDT-NO:** 30 AMPS, 277 VAC.  
20 AMPS, 28 VDC  
**DPST-NO:** 30 AMPS, 277 VAC.  
20 AMPS, 28 VDC  
**DPDT-NC:** 3 AMPS, 277 VAC. 28 VDC

5 AMPS, 120 VAC 50/60Hz/ 28 VDC  
BIFURCATED  
3AMPS, 1240 VAC 50/60Hz / 28 VDC

10 AMPS, 120/240 VAC 50/60Hz  
10 AMPS, 28 VDC

**COIL DATA**

STANDARD VOLTAGE  
AC:  
DC:

24, 120 & 240 VAC  
12, 24, 48 & 110 VDC

120 VAC  
5, 12, 24, 48, 115 VDC

6,12, 24, 120, 220/230, 240 VAC  
6, 12, 24, 48, 110 VDC

NOMINAL COIL POWER  
VA: (VAC)  
WATTS: (VDC)

4 VA  
1.7 WATTS

1.5 TO 2.5 VA  
1 TO 2.0 WATTS

1.2 VA  
0.9 WATTS

INSULATION SYSTEM PER  
UL STANDARD 1446

CLASS "B" (130°C)

**GENERAL DATA**

AMBIENT TEMPERATURE  
OPERATING:

- 40°C TO +65°C (AC)  
- 40°C TO +85°C (DC)

-55°C TO +70°C

-40°C TO +70°C

STORAGE:

- 55°C TO +155 C

-55°C TO +105°C

-40°C TO +105°C

DIELECTRIC STRENGTH:  
(COIL TO FRAME)

4000 V rms

1500 V rms

1500 V rms

LIFE EXPECTANCY

ELECTRICAL:  
MECHANICAL:

100,000 OPERATIONS  
5,000,000 OPERATIONS

100,000 OPERATIONS  
10,000,000 OPERATIONS

100,000 OPERATIONS  
10,000,000 OPERATIONS

**MATING SOCKETS**

SEE SECTION 8

**OPTIONAL DIN ADAPTER  
16-92 DIN-1**

**70-303-1, 70-305-1, 70-307-1,  
70-304-1, 70-306-1, 70-308-1**  
PAGE 23, 24

**27390, 33377, 70-219D-12  
OR 70-219D-14**  
PAGE 25

**AGENCY APPROVALS**

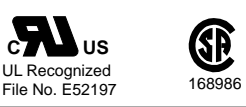

**PAGE NUMBER**

1...7

PAGE 47 - 48

PAGE 49 - 50

PAGE 51 - 52



750H



21



L W H  
1.281 x 0.910 x 1.156

L W H  
2.84 X 1.85 X 2.47

- 8 & 11 PIN OCTAL BASE
- HERMETICALLY SEALED VACUUM BAKED AND DRY NITROGEN FILLED
- GRAY LACQUER FINISH OVER STEEL ENCLOSURE
- MEETS UL STANDARD FOR CLASS 1 DIVISION 2 HAZARDOUS LOCATIONS
- UL LISTED WHEN USED WITH 70-464-1 OR 70-465-1 SOCKETS

- PLUG-IN BASE WITH POLARIZING PIN
- SWITCHES TUNGSTEN LOADS UP TO 20 AMPS
- MEETS NEMA STD. TS 2-1992 APPROVED BY D. O. T.

DPDT, 3PDT

DPDT

SILVER ALLOY,  
GOLD DIFFUSED

SILVER ALLOY

**DPDT:** 12 AMPS, 120 VAC 50/60Hz  
8 AMPS, 240 VAC 50/60Hz,  
10 AMPS, 28 VDC  
**3PDT:** 10 AMPS, 120 VAC 50/60Hz  
6 AMPS, 240 VAC 50/60Hz,  
10 AMPS, 28 VDC

30 AMPS, 120/240 VAC 50/60Hz  
20 AMP, 28 VDC  
20 AMPS, 120 VAC 50/60Hz, TUNGSTEN  
10 AMPS, 240 VAC 50/60Hz, TUNGSTEN

12, 24, 120 VAC  
12, 24, 110 VDC

120 VAC RECTIFIED

2 - 2.75 VA  
1.2 WATTS

4.0 VA

CLASS "B" (130°C)

-45°C TO +55°C (AC)  
-45°C TO +70°C (DC)  
-40°C TO +105°C

-40°C TO +84°C  
-40°C TO +105°C

1250 V rms

1500 V rms

100,000 OPERATIONS  
5,000,000 OPERATIONS

200,000 OPERATIONS  
5,000,000 OPERATIONS

70-464-1, 70-465-1

—

PAGE 7, 8



PAGE 53 - 54

PAGE 55

**Magnecraft & Struthers-Dunn**

Your Contact for Industrial Relays

**U. S. A.**

TELEPHONE: (843) 393-5778

FAX: (843) 393-4123

WEBSITE: [www.magnecraft.com](http://www.magnecraft.com)

EMAIL: [info@magnecraft.com](mailto:info@magnecraft.com)

**EUROPE**

TELEPHONE: 4989 / 75080310

FAX: 4989 / 7559344

WEBSITE: [www.magnecraft.com](http://www.magnecraft.com)

EMAIL: [renatesteinback@magnecraft.de](mailto:renatesteinback@magnecraft.de)

**FEATURES**

**BENEFITS**

<b>FLAG INDICATOR:</b>	SHOWS RELAY STATUS IN MANUAL OR POWERED CONDITION.
<b>BI - POLAR L.E.D. STATUS LAMP:</b>	SHOWS COIL "ON" OR "OFF" STATUS. IDEAL IN LOW LIGHT CONDITIONS.
<b>PUSH BUTTON:</b>	ALLOWS FOR MANUAL OPERATION OF RELAY WITHOUT THE NEED FOR COIL POWER. IDEAL FOR FIELD SERVICE PERSONNEL TO TEST CONTROL CIRCUITS.
<b>FINGER-GRIP COVER:</b>	ALLOWS OPERATOR TO REMOVE RELAYS FROM SOCKETS MORE EASILY THAN CONVENTIONAL RELAYS.
<b>I.D. TAG/WRITE LABEL:</b>	USED FOR IDENTIFICATION OF RELAYS IN MULTI-RELAY CIRCUITS.
<b>COVER ADAPTERS:</b>	DIN RAIL ADAPTER OR TOP/BOTTOM FLANGE ADAPTER, ALLOWS THE 781 RELAY TO BE DIRECT MOUNTED TO A DIN RAIL OR PANEL.

**SPDT, 15 AMPS**

**UL** us **SP** 97899  
 UL Recognized  
 File No. E43641

**UL** LISTED 367G  
 IND. CONT. EQ.  
 C US

**CE**

COMPLIES WITH REQUIREMENTS OF

- \* IEC STANDARDS 947-4-1 AND 947-5-1 LOW VOLTAGE DIRECTIVE
- \* IEC = INTERNATIONAL ELECTROTECHNICAL COMMISSION
- \* CE TESTING AND EVALUATION PERFORMED BY THE UNDERWRITERS LABORATORIES AS A THIRD PARTY PARTICIPANT

WHEN USED WITH SOCKETS **70-781D-1**

CURRENT LIMITED TO RATING OF RELAY OR SOCKET WHICHEVER IS LESS

**MANUFACTURED UNDER ISO 9002 & QS 9000**

**STANDARD COVER**



**STANDARD COVER WITH FLANGE ADAPTER 16-781C1 ON TOP**



**TOP OR BOTTOM FLANGE ADAPTER ORDERED AND SHIPPED SEPARATELY**



**STANDARD COVER WITH FLANGE ADAPTER 16-781C1 ON BOTTOM**

**TOP OR BOTTOM FLANGE ADAPTER ORDERED AND SHIPPED SEPARATELY**



**STANDARD COVER WITH DIN ADAPTER 16-781C**

**DIN ADAPTER ORDERED AND SHIPPED SEPARATELY**

**GENERAL SPECIFICATIONS**

**COIL**

Pull-in Voltage:	75% of nominal voltage or less for DC coils, 80% of nominal voltage or less for AC coils
Dropout Voltage:	DC-10%, AC-30% of nominal voltage or more
Max. Voltage:	110%
Resistance:	±15% measured @ 25°C.
Coil Power:	0.7 watts DC, 0.9 VA (60Hz) AC @ 25°C
Insulation System:	Class "B" (130°C per UL standard 1446)
Max. Coil Dissipation:	2.3 watts DC, 2.55 VA (60Hz) AC @ 25°C
Duty:	Continuous

**CONTACTS**

Contact Material:	Silver alloy, gold flashed
Contact Rating:	15 amps @ 110/120 VAC 50/60Hz. 12 amps @ 220/277 VAC 50/60Hz. 15 amps @ 28 VDC. 1/2Hp @ 110/120 VAC 50/60Hz. 1Hp @ 220/250 VAC 50/60Hz. B300 pilot duty 50/60Hz. 10 amps @ 120 VAC general purpose 10 amps @ 240 VAC general purpose (general purpose load, 75% to 80% power factor)

**DIELECTRIC STRENGTH**

Coil to Frame:	1500 V rms
Across Open Contacts:	1000 V rms
Contacts to Frame:	1500 V rms
Insulation Resistance:	100 megohms @ 500 VDC

**TEMPERATURE**

Operating:	-40°C to +70°C
Storage:	-40°C to +100°C

**LIFE EXPECTANCY**

Electrical:	150,000 operations @ rated resistive load
Mechanical:	10,000,000 operations @ no load

**MISCELLANEOUS**

Operating Position:	Any
Insulation Material:	Molded plastic
Enclosure:	Polycarbonate dust cover
Weight:	29 grams approx.

**Mating Sockets**  
**70-781D-1: SCREW/DIN**  
**70-781F-1: SOLDER**  
**70-781T-1: PRINTED CIRCUIT**  
 See section 8, page 18, 19



**SPDT, 15 AMPS**

**NEW**  
From The Market  
Leader in Industrial  
Relays

**OUTLINE DIMENSIONS**  
DIMENSIONS SHOWN IN INCHES & (MILLIMETERS).

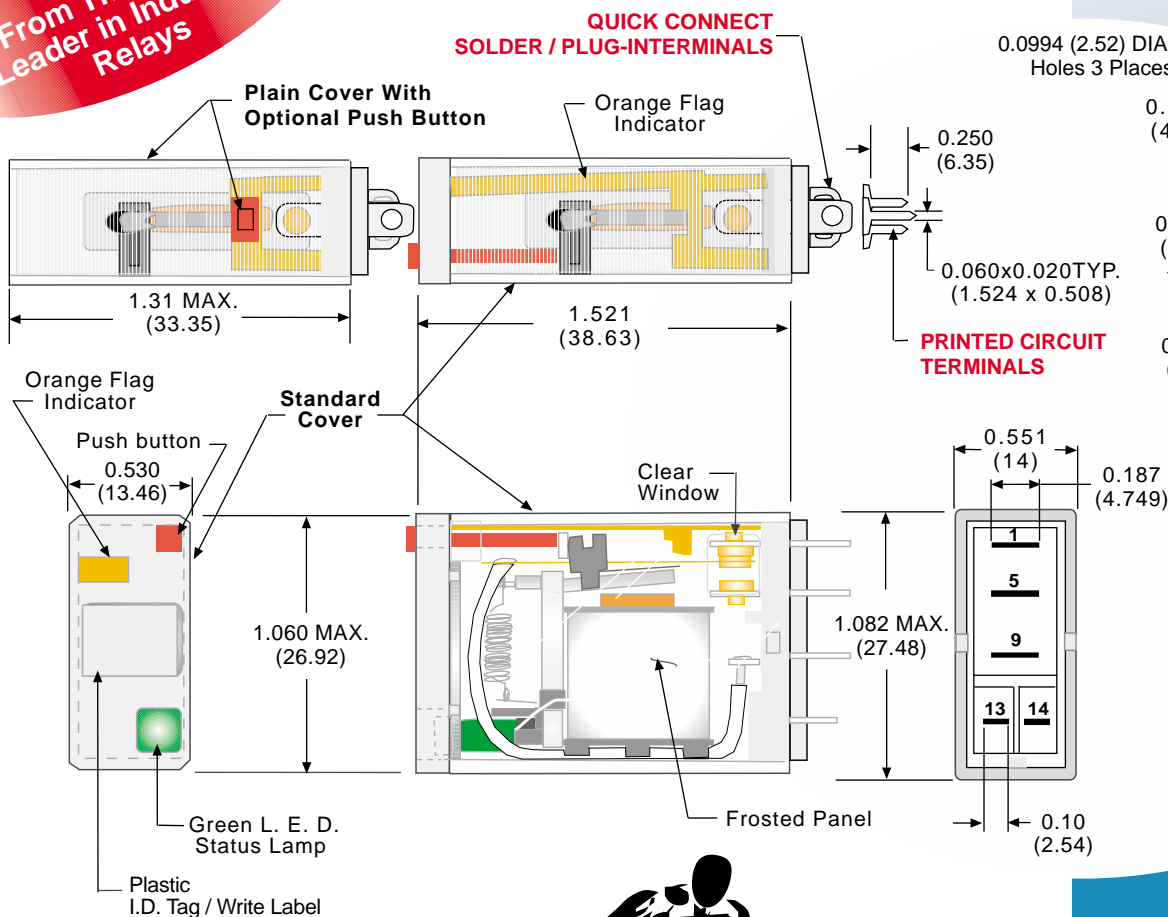

**PRINTED CIRCUIT MOUNTING HOLE LAYOUT (BOTTOM VIEW)**

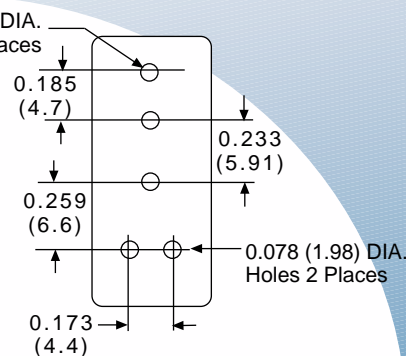

**WIRING DIAGRAM (VIEWED FROM PIN END)**

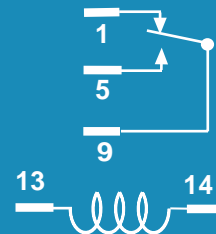

**BI - POLAR L.E.D. STATUS LAMP ALLOWS FOR REVERSE POLARITY APPLICATIONS**

**ORDERING CODE FOR RELAYS**

**CLASS:** 781

**CONTACT CONFIGURATION:** XAX  
SPDT: XAX

**TERMINAL STYLE:** ML  
QUICK CONNECT SOLDER / PLUG-IN TERMINALS: NO CODE  
PRINTED CIRCUIT TERMINALS: CODE T

**OPTIONAL PLAIN COVER:** -120A  
CODE C

**STANDARD COVER FEATURES:**  
PUSH BUTTON : CODE M  
BI - POLAR L.E.D. STATUS LAMP: CODE L

**OPTIONAL PLAIN COVER FEATURES:**  
PUSH BUTTON : CODE M  
BI - POLAR L.E.D. STATUS LAMP: CODE L

**COIL VOLTAGE:**  
6, 12, 24, 120, 220/230, 240 ADD "A" FOR AC COILS  
6, 12, 24, 48, 110 ADD "D" FOR DC COILS

STANDARD PART NUMBERS SPDT	COIL MEASURED @ 25°C		
	PLAIN COVER	NOMINAL INPUT VOLTAGE	NOMINAL RESISTANCE (OHMS)
<b>AC OPERATED - SOLDER/PLUG-IN, 15 AMP</b>			
781XAXML-24A	781XAXC-24A	24 VAC, 50/60Hz	180 Ω
781XAXML-120A	781XAXC-120A	120 VAC, 50/60Hz	4,430 Ω
781XAXML-240A		240 VAC, 50/60HZ	9,100 Ω
<b>DC OPERATED - SOLDER/PLUG-IN, 15 AMP</b>			
781XAXML-12D		12 VDC	120 Ω
781XAXML-24D	781XAXC-24D	24 VDC	470 Ω
781XAXML-110D		110 VDC	10,000 Ω
<b>AC OPERATED - PRINTED CIRCUIT, 15 AMP</b>			
781XAXTML-120A		120 VAC, 50/60Hz	4,430 Ω
<b>DC OPERATED - PRINTED CIRCUIT, 15 AMP</b>			
781XAXTML-12D		12 VDC	120 Ω
781XAXTML-24D		24 VDC	470 Ω

RETROFITS IDEC RH1B- & RH1V2-. SEE END OF SECTION 1 FOR CROSS REFERENCE CADMIUM-FREE CONTACTS AVAILABLE, CONTACT FACTORY FOR DETAILS

**4PDT, 1, 3 & 5 AMPS**

## FEATURES

## BENEFITS

- VACUUM BAKED & DRY NITROGEN FILLED**
- HERMETICALLY SEALED METAL ENCLOSURE**
- CHOICE OF CONTACT RATINGS 1 AMP, 3 AMPS AND 5 AMPS**
- PLUG-IN STYLE OR SIDE MOUNTING STUD WITH ANTI-ROTATION TAB**

REMOVES CONTAMINANTS AND PROVIDES A CLEAN & DRY ATMOSPHERE FOR CONTACTS.

IDEAL FOR USE IN HAZARDOUS LOCATIONS. UL CERTIFIED FOR CLASS 1 DIVISION 2 GROUP A, B, C & D HAZARDS. WHEN RELAY IS USED WITH 70-461-1 SOCKET, THE HOLD-DOWN CLIP 16-1328 IS REQUIRED.

PROVIDES FOR LOW LEVEL SWITCHING APPLICATIONS UP TO 5 AMPS POWER LOADS.

WHEN USED WITH 70-461-1 SOCKET THE 782H CAN BE DIN RAIL MOUNTED OR PANEL MOUNTED. THE SIDE STUD PROVIDES FOR DIRECT MOUNT & SOLDERED WIRE APPLICATIONS.

**cULus**  
UL Recognized  
File No. E209950

**SR** 168986

**UL** LISTED 367G  
IND. CONT. EQ.

**CE**

COMPLIES WITH REQUIREMENTS OF

- \* IEC STANDARDS 947-4-1 AND 947-5-1 LOW VOLTAGE DIRECTIVE
- \* IEC = INTERNATIONAL ELECTROTECHNICAL COMMISSION
- \* CE TESTING AND EVALUATION PERFORMED BY THE UNDERWRITERS LABORATORIES AS A THIRD PARTY PARTICIPANT

WHEN USED WITH SOCKET 70-461-1

CURRENT LIMITED TO RATING OF RELAY OR SOCKET WHICHEVER IS LESS

## GENERAL SPECIFICATIONS

### COIL

Pull-in Voltage: 75% of nominal voltage or less for DC coils, 80% of nominal voltage or less for AC coils

Dropout Voltage: DC-10%, AC-30% of nominal voltage or more

Max. Voltage: 110%

Resistance: ±15% measured @ 25°C

Coil Power: 0.9 watts DC. 1.2 VA (60Hz) AC @ 25°C

Insulation System: Class "B" (130°C per UL standard. 1446)

Max. Coil Dissipation: 2.0 watts DC, 2.5 VA (60Hz) AC. @ 25°C. 5 minutes maximum @ 25°C

Duty: Continuous

**MANUFACTURED UNDER ISO 9001**

### CONTACTS

Contact Material: See ordering code

Contact Rating: See ratings table

**UL GROUPS A, B, C & D CERTIFIED CLASS 1 DIVISION 2 FOR HAZARDOUS LOCATIONS**

### TIMING

Operate Time: 13 mS max @ nominal voltage

Release Time: 6 mS max @ nominal voltage

### DIELECTRIC STRENGTH

Contacts to Coil: 1240 V rms

Across Open Contacts: 500 V rms

Contacts to Frame: 1240 V rms

Insulation Resistance: 100 megohms @ 500 VDC

### TEMPERATURE

Operating: -45°C to +70°C

Storage: -60°C to +130°C

### VIBRATION RESISTANCE

Functional: 10 to 55Hz; 6 g's (double amplitude)

### SHOCK RESISTANCE

Functional: 10 g's (11mS)

### LIFE EXPECTANCY

Electrical: 100,000 operations @ rated resistive load

Mechanical: 10,000,000 operations @ no load

### MISCELLANEOUS

Operating Position: Any

Insulation Material: Molded plastic

Enclosure: Grey metal case, hermetically sealed

Weight: 45 grams approx.

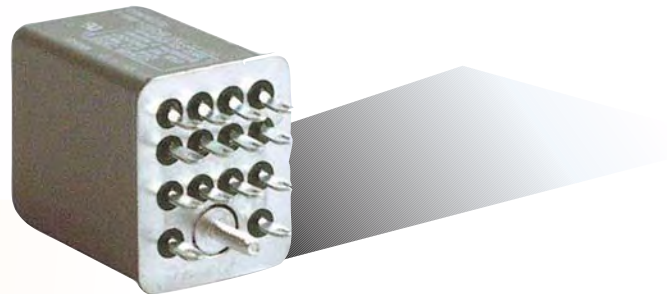

**Mating Sockets**  
70-461-1: SCREW/DIN  
70-378-1: SOLDER  
70-379-1: PRINTED CIRCUIT  
See section 8, page 14, 15



**4PDT, 1, 3 & 5 AMPS**

**NEW**  
From The Market  
Leader in Industrial  
Relays

**OUTLINE DIMENSIONS**  
DIMENSIONS SHOWN IN INCHES & (MILLIMETERS).

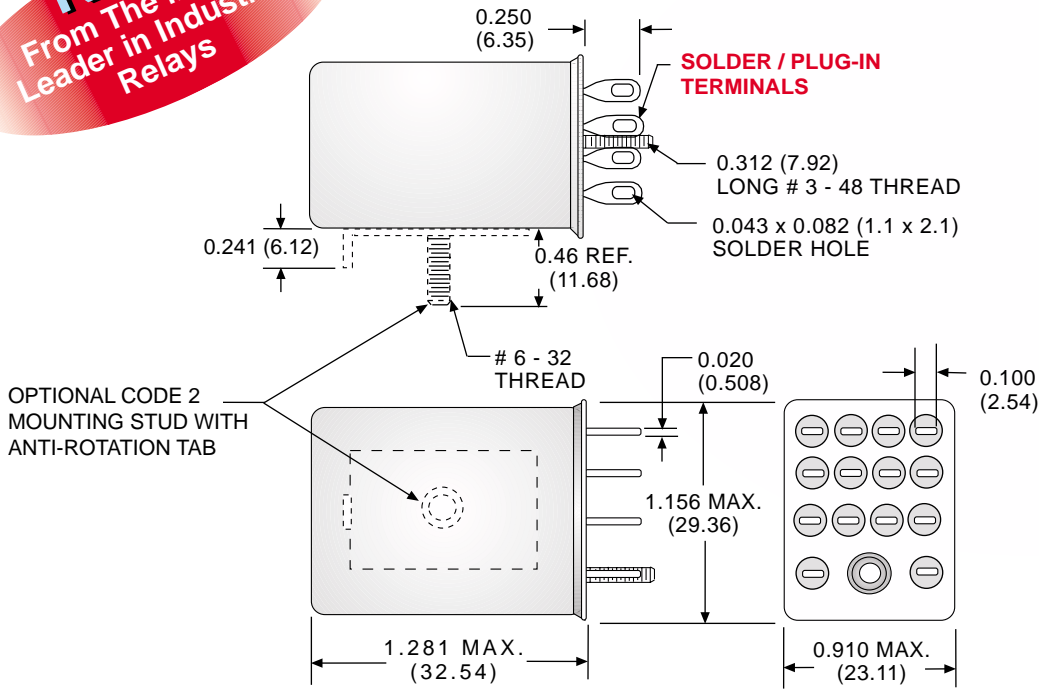

**WIRING DIAGRAM**  
(VIEWED FROM PIN END)

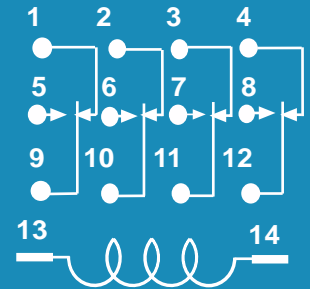

**UL CONTACT LOAD RATINGS TABLE**

POLES	CURRENT OR HORSE POWER	LOAD VOLTAGE	LOAD VOLTAGE FREQUENCY	TYPE OF LOAD	MINIMUM LOAD
4 POLES	1 AMP	120/240	50/60 Hz	RESISTIVE	DRY CIRCUIT
	3 AMP	120/240	50/60 Hz	RESISTIVE	100 mA 12 VAC
	5 AMP	120/240	50/60 Hz	RESISTIVE	500 mA 12 VAC
	1 AMP	30	DC	RESISTIVE	DRY CIRCUIT
	3 AMP	30	DC	RESISTIVE	100 mA 12 VDC
	5 AMP	30	DC	RESISTIVE	500 mA 12 VDC

**ORDERING CODE FOR RELAYS**

**782 XDX H 32 - 24D**

**CLASS:** \_\_\_\_\_

**CONTACT CONFIGURATION:** \_\_\_\_\_  
4PDT: XDX

**HERMETICALLY SEALED:** \_\_\_\_\_

**CONTACT RATING:** \_\_\_\_\_  
1 AMP BIFURCATED: **CODE 32**  
( SILVER CROSS BAR WITH GOLD OVERLAY)  
3 AMP: **CODE 10**  
( SILVER GOLD FLASHED)  
5 AMP: **CODE 21**  
( SILVER CADMIUM OXIDE)

**TERMINALS & MOUNTING STYLE:** \_\_\_\_\_  
SOLDER/PLUG-IN: **NO CODE**  
SOLDER WITH STUD ON BROAD SIDE: **CODE 2**

**COIL VOLTAGE:** \_\_\_\_\_  
6, 12, 24, 120, 240 ADD "A" FOR AC COILS  
6, 12, 24, 48, 110 ADD "D" FOR DC COILS

STANDARD PART NUMBERS 4PDT	COIL MEASURED @ 25°C	
	NOMINAL INPUT VOLTAGE	NOMINAL RESISTANCE (OHMS)
<b>AC OPERATED - SOLDER/PLUG-IN, 3 AMP</b>		
782DXH10-24A	24 VAC, 50/60Hz	7160 Ω
782DXH10-120A	120 VAC, 50/60Hz	3,900 Ω
<b>DC OPERATED - SOLDER/PLUG-IN, 3 AMP</b>		
782DXH10-12D	12 VDC	160 Ω
782DXH10-24D	24 VDC	650 Ω
782DXH10-110D	110 VDC	11,000 Ω
<b>AC OPERATED - SOLDER/PLUG-IN, 5 AMP</b>		
782DXH21-120A	120 VAC, 50/60Hz	3,900 Ω
<b>DC OPERATED - SOLDER/PLUG-IN, 5 AMP</b>		
782DXH21-12D	12 VDC	160 Ω
782DXH21-24D	24 VDC	650 Ω

RETROFITS POTTER & BRUMFIELD KHS OR OMRON MY4H.  
SEE END OF SECTION 1 FOR CROSS REFERENCE

**DPDT & 4PDT  
3, 10 & 15 AMPS**

**FEATURES**

**BENEFITS**

<b>FLAG INDICATOR:</b>	SHOWS RELAY STATUS IN MANUAL OR POWERED CONDITION.
<b>BI - POLAR</b>	SHOWS COIL "ON" OR "OFF" STATUS. IDEAL IN LOW LIGHT CONDITIONS.
<b>L.E.D. STATUS LAMP:</b>	ALLOWS FOR MANUAL OPERATION OF RELAY WITHOUT THE NEED FOR COIL POWER. IDEAL FOR FIELD SERVICE PERSONNEL TO TEST CONTROL CIRCUITS.
<b>PUSH BUTTON:</b>	WHEN ACTIVATED, HOLDS PUSH BUTTON AND CONTACTS IN THE OPERATE POSITION. EXCELLENT FOR ANALYZING CIRCUIT PROBLEMS.
<b>LOCK-DOWN DOOR:</b>	ALLOWS OPERATOR TO REMOVE RELAYS FROM SOCKETS MORE EASILY THAN CONVENTIONAL RELAYS.
<b>FINGER-GRIP COVER:</b>	USED FOR IDENTIFICATION OF RELAYS IN MULTI-RELAY CIRCUITS.
<b>I.D. TAG/WRITE LABEL:</b>	DIN RAIL FLANGE ADAPTER OR TOP/BOTTOM FLANGE ADAPTER, ALLOWS THE 782 RELAY TO BE DIRECT MOUNTED TO A DIN RAIL OR PANEL.
<b>COVER ADAPTERS:</b>	

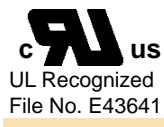

IND. CONT. EQ.

WHEN USED WITH SOCKETS 70-782D-1, 70-459-1 OR 70-461-1

CURRENT LIMITED TO RATING OF RELAY OR SOCKET WHICHEVER IS LESS

**MANUFACTURED UNDER  
ISO 9002 & QS 9000**

**GENERAL SPECIFICATIONS**

**COIL**

Pull-in Voltage:	75% of nominal voltage or less for DC coils, 80% of nominal voltage or less for AC coils
Dropout Voltage:	DC-10% , AC-30% of nominal voltage or more
Max. Voltage:	110%
Resistance:	±15% measured @ 25°C
Coil Power:	0.9 watts DC, 1.2 VAC (60Hz) AC @ 25°C
Insulation System:	Class "B" (130°C per UL standard 1446)
Max. Coil Dissipation:	2.3 watts DC, 2.55 VAC (60Hz) AC @ 25°C
Duty:	Continuous

**CONTACTS**

Contact Material:	3 amps bifurcated silver gold plated. 3 amps silver gold flashed 10 & 15 amps, silver alloy, gold flashed
Contact Rating:	<b>DPDT, 4PDT-</b> Bifurcated 3 amps @ 120/240 VAC 30 VDC. 1/16Hp (2.8 amp FLA), 120 VAC. Pilot duty - 5 amps make, 1/2 amp break, 3 amps continuous, 120 VAC <b>DPDT, 4PDT-</b> 3 amps @ 120/240 VAC, 30 VDC, 1/6 Hp 120/240 VAC, C300 pilot duty. <b>DPDT, 4PDT-</b> 10 amps @ 110/120 VAC, 8 amps @ 220/277 VAC. 8 amps @ 28 VDC, 1/3 Hp 250 VAC, B300 pilot duty. <b>DPDT-</b> 15 amps @ 110/120 VAC, 12 amps @ 220/277 VAC (20 amps max.) 12 amps 28 VDC, 1/2 Hp, 120 VAC. 1 Hp 250 VAC, B300 pilot duty

**DIELECTRIC STRENGTH**

Coil To Frame:	1500 V rms
Across Open Contacts:	1000 V rms
Contacts To Frame:	1500 V rms
Insulation Resistance:	100 megohms @ 500 VDC

**TEMPERATURE**

Operating:	-40°C to +70°C
Storage:	-40°C to +105°C

**LIFE EXPECTANCY**

Electrical:	200,000 operations @ rated resistive load
Mechanical:	10,000,000 operations @ no load

**MISCELLANEOUS**

Operating Position:	Any
Insulation Material	Molded plastic
Enclosure:	Polycarbonate dust cover
Weight:	36 grams approx



STANDARD COVER



STANDARD COVER WITH FLANGE ADAPTER 16-782C1 ON TOP

**TOP OR BOTTOM FLANGE ADAPTER ORDERED AND SHIPPED SEPARATELY**



STANDARD COVER WITH FLANGE ADAPTER 16-782C1 ON BOTTOM

**TOP OR BOTTOM FLANGE ADAPTER ORDERED AND SHIPPED SEPARATELY**



STANDARD COVER WITH DIN ADAPTER 16-782C

**DIN ADAPTER ORDERED AND SHIPPED SEPARATELY**

**Mating Sockets**  
70-782D-1, 70-461-1,  
70-459-1: SCREW/DIN  
70-379-1, 70-378-1: SOLDER  
70-401-1, 70-402-1:  
**PRINTED CIRCUIT**



See section 8, page 13, 14, 15

**DPDT, 3 & 10 AMPS**

**NEW**  
From The Market  
Leader in Industrial  
Relays

**OUTLINE DIMENSIONS**  
DIMENSIONS SHOWN IN INCHES & (MILLIMETERS).

**PRINTED CIRCUIT MOUNTING HOLE LAYOUT**  
(BOTTOM VIEW)

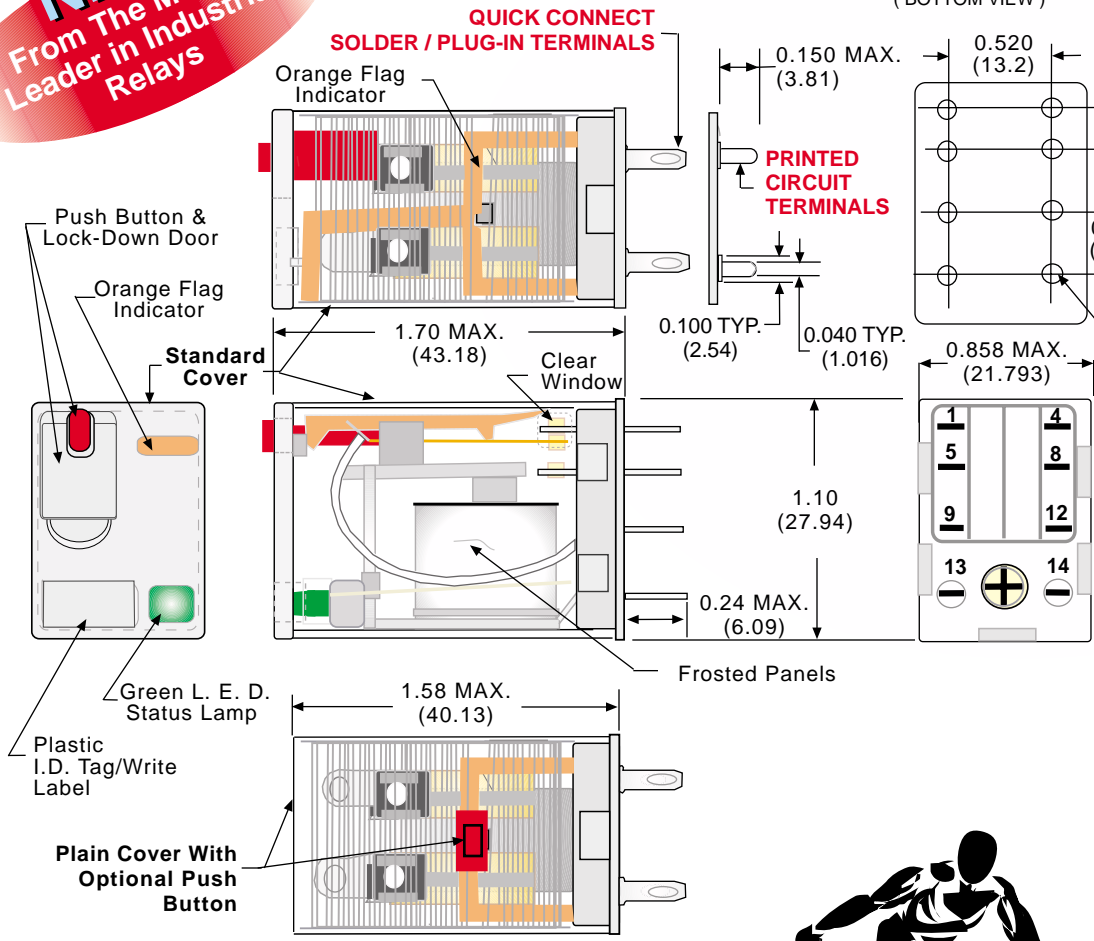

AVAILABLE WITHOUT  
LOCK-DOWN DOOR: CODE "M"

**WIRING DIAGRAM**  
(VIEWED FROM PIN END)

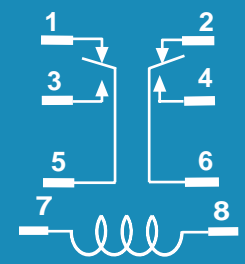

**ORDERING CODE FOR RELAYS**

**782**      **XBX**      **M4L**      **-120A**

**CLASS:** \_\_\_\_\_

**CONTACT CONFIGURATION:** DPDT: **XBX**

**TERMINAL STYLE:** QUICK CONNECTSOLDER/  
PLUG-IN TERMINALS: **NO CODE**  
PRINTED CIRCUIT TERMINALS: **CODE T**

**CONTACT RATING:** \_\_\_\_\_  
3 AMP: **CODE 1**  
10 AMP: **CODE 2**  
3 AMP BIFURCATED CONTACT: **CODE 3**

**OPTIONAL PLAIN COVER:** \_\_\_\_\_  
**CODE C**

**STANDARD COVER FEATURES:** \_\_\_\_\_  
PUSH BUTTON & LOCK-DOWN DOOR: **CODE M4**  
BI - POLAR L.E.D. STATUS LAMP: **CODE L**

**OPTIONAL STANDARD COVER DELETION:** \_\_\_\_\_  
PUSH BUTTON AND BI - POLAR L.E.D. WITHOUT  
LOCK-DOWN DOOR: **CODE ML**

**OPTIONAL PLAIN COVER FEATURES:** \_\_\_\_\_  
PUSH BUTTON WITHOUT LOCK-DOWN DOOR: **CODE M**  
BI - POLAR L.E.D. STATUS LAMP: **CODE L**

**COIL VOLTAGE:** \_\_\_\_\_  
6, 12, 24, 120, 220/230, 240 ADD "A" FOR AC COILS  
6, 12, 24, 110 ADD "D" FOR DC COILS



BI - POLAR  
L.E.D. STATUS LAMP  
ALLOWS FOR REVERSE  
POLARITY APPLICATIONS

STANDARD PART NUMBERS DPDT	COIL MEASURED @ 25°C	
	NOMINAL INPUT VOLTAGE	NOMINAL RESISTANCE (OHMS)
<b>AC OPERATED - SOLDER/PLUG-IN, 10 AMP</b>		
782XBX2M4L-24A	24 VAC, 50/60Hz	72 Ω
782XBX2M4L-120A	120 VAC, 50/60Hz	1,700 Ω
782XBX2M4L-240A	240 VAC, 50/60HZ	9,100 Ω
<b>DC OPERATED - SOLDER/PLUG-IN, 10 AMP</b>		
782XBX2M4L-12D	12 VDC	120 Ω
782XBX2M4L-24D	24 VDC	470 Ω
782XBX2M4L-110D	110 VDC	10,000 Ω
<b>AC OPERATED - SOLDER/PLUG-IN, 3 AMP, BIFURCATED</b>		
782XBX3M4L-24A	24 VAC, 50/60Hz	72 Ω
782XBX3M4L-120A	120 VAC, 50/60Hz	1,700 Ω
782XBX3M4L-240A	240 VAC, 50/60HZ	9,100 Ω
<b>DC OPERATED - SOLDER/PLUG-IN, 3 AMP, BIFURCATED</b>		
782XBX3M4L-12D	12 VDC	120 Ω
782XBX3M4L-24D	24 VDC	470 Ω
782XBX3M4L-110D	110 VDC	10,000 Ω

RETROFITS SCHRACK PT.  
SEE END OF SECTION 1 FOR CROSS REFERENCE  
CADMIUM-FREE CONTACTS AVAILABLE,  
CONTACT FACTORY FOR DETAILS

**4PDT, 3 & 10 AMPS**

**NEW**  
From The Market  
Leader in Industrial  
Relays

**OUTLINE DIMENSIONS**  
DIMENSIONS SHOWN IN INCHES & (MILLIMETERS).

**PRINTED CIRCUIT  
MOUNTING HOLE LAYOUT**  
(BOTTOM VIEW)

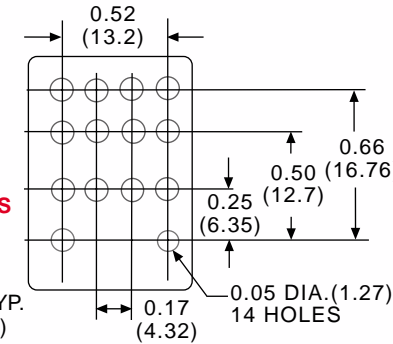
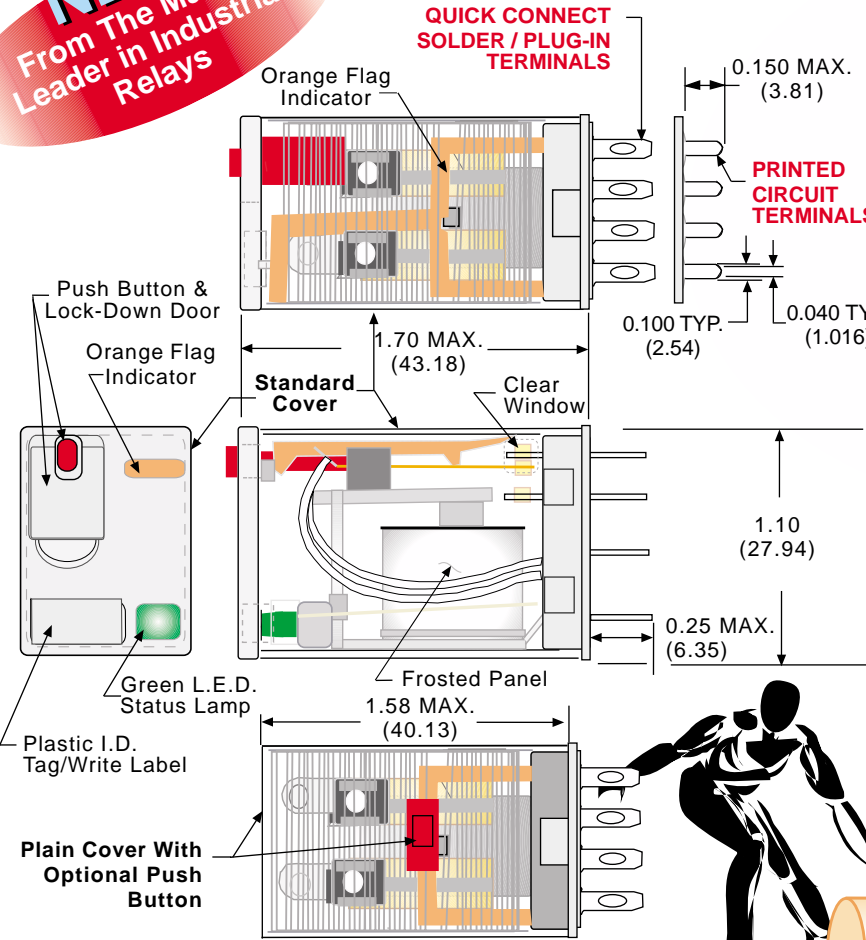

AVAILABLE WITHOUT  
LOCK-DOWN DOOR: CODE "M"

**WIRING DIAGRAM**  
(VIEWED FROM PIN END)

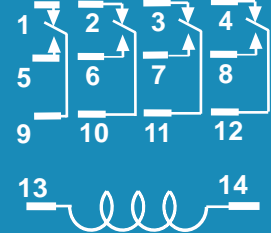

ALL 4 POLE RELAYS HAVE OPPOSITE  
POLARITY ARC BARRIERS AS A  
STANDARD FEATURE TO PROVIDE  
GREATER VOLTAGE PROTECTION  
BETWEEN ADJACENT POLES

BI - POLAR  
L.E.D. STATUS LAMP  
ALLOWS FOR REVERSE  
POLARITY APPLICATIONS

**ORDERING CODE FOR RELAYS**

**CLASS:** 782

**CONTACT CONFIGURATION:** 4PDT: XDX

**TERMINAL STYLE:** QUICK CONNECTSOLDER/ PLUG-IN TERMINALS: NO CODE  
PRINTED CIRCUIT TERMINALS: CODE T

**CONTACT RATING:** 3 AMP: CODE 1  
10 AMP: CODE 2  
3 AMP BIFURCATED CONTACT: CODE 3

**OPTIONAL PLAIN COVER:** CODE C

**STANDARD COVER FEATURES:** PUSH BUTTON & LOCK-DOWN DOOR: CODE M4  
BI - POLAR L.E.D. STATUS LAMP: CODE L

**OPTIONAL STANDARD COVER DELETION:** PUSH BUTTON AND BI - POLAR L.E.D. WITHOUT  
LOCK-DOWN DOOR: CODE ML

**OPTIONAL PLAIN COVER FEATURES:** PUSH BUTTON WITHOUT LOCK-DOWN DOOR: CODE M  
BI - POLAR L.E.D. STATUS LAMP: CODE L

**COIL VOLTAGE:** 6, 12, 24, 120, 220/230, 240 ADD "A" FOR AC COILS  
6, 12, 24, 48, 110 ADD "D" FOR DC COILS

**COIL MEASURED @ 25°C**

STANDARD PART NUMBERS 4PDT	NOMINAL INPUT VOLTAGE	NOMINAL RESISTANCE (OHMS)
<b>AC OPERATED - QUICK CONNECT SOLDER/PLUG-IN, 3 AMP</b>		
782XDX1M4L-24A	24 VAC, 50/60Hz	72 Ω
782XDX1M4L-120A	120 VAC, 50/60Hz	1,700 Ω
782XDX1M4L-240A	240 VAC, 50/60HZ	9,100 Ω
<b>DC OPERATED - QUICK CONNECT SOLDER/PLUG-IN, 3 AMP</b>		
782XDX1M4L-12D	12 VDC	120 Ω
782XDX1M4L-24D	24 VDC	470 Ω
782XDX1M4L-110D	110 VDC	10,000 Ω
<b>AC OPERATED - SOLDER/PLUG-IN, 10 AMP</b>		
782XDX2M4L-24A	24 VAC, 50/60Hz	72 Ω
782XDX2M4L-120A	120 VAC, 50/60Hz	1,700 Ω
782XDX2M4L-240A	240 VAC, 50/60HZ	9,100 Ω
<b>DC OPERATED - SOLDER/PLUG-IN, 10 AMP</b>		
782XDX2M4L-12D	12 VDC	120 Ω
782XDX2M4L-24D	24 VDC	470 Ω
782XDX2M4L-110D	110 VDC	10,000 Ω
<b>AC OPERATED - SOLDER/PLUG-IN, 3 AMP, BIFURCATED</b>		
782XDX3M4L-24A	24 VAC, 50/60Hz	72 Ω
782XDX3M4L-120A	120 VAC, 50/60Hz	1,700 Ω
782XDX3M4L-240A	240 VAC, 50/60HZ	9,100 Ω
<b>DC OPERATED - SOLDER/PLUG-IN, 3 AMP, BIFURCATED</b>		
782XDX3M4L-12D	12 VDC	120 Ω
782XDX3M4L-24D	24 VDC	470 Ω
782XDX3M4L-110D	110 VDC	10,000 Ω

RETROFITS SCHRACK PT.  
SEE END OF SECTION 1 FOR CROSS REFERENCE



**DPDT, 15 AMPS**

**NEW**  
From The Market  
Leader in Industrial  
Relays

**OUTLINE DIMENSIONS**  
DIMENSIONS SHOWN IN INCHES & (MILLIMETERS).

**PRINTED CIRCUIT  
MOUNTING HOLE LAYOUT**  
(BOTTOM VIEW)

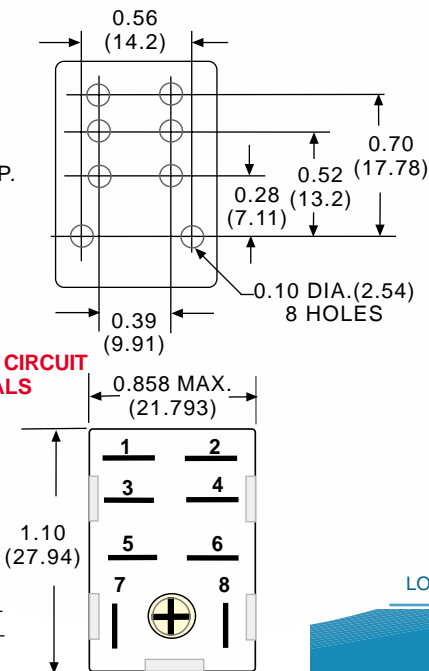
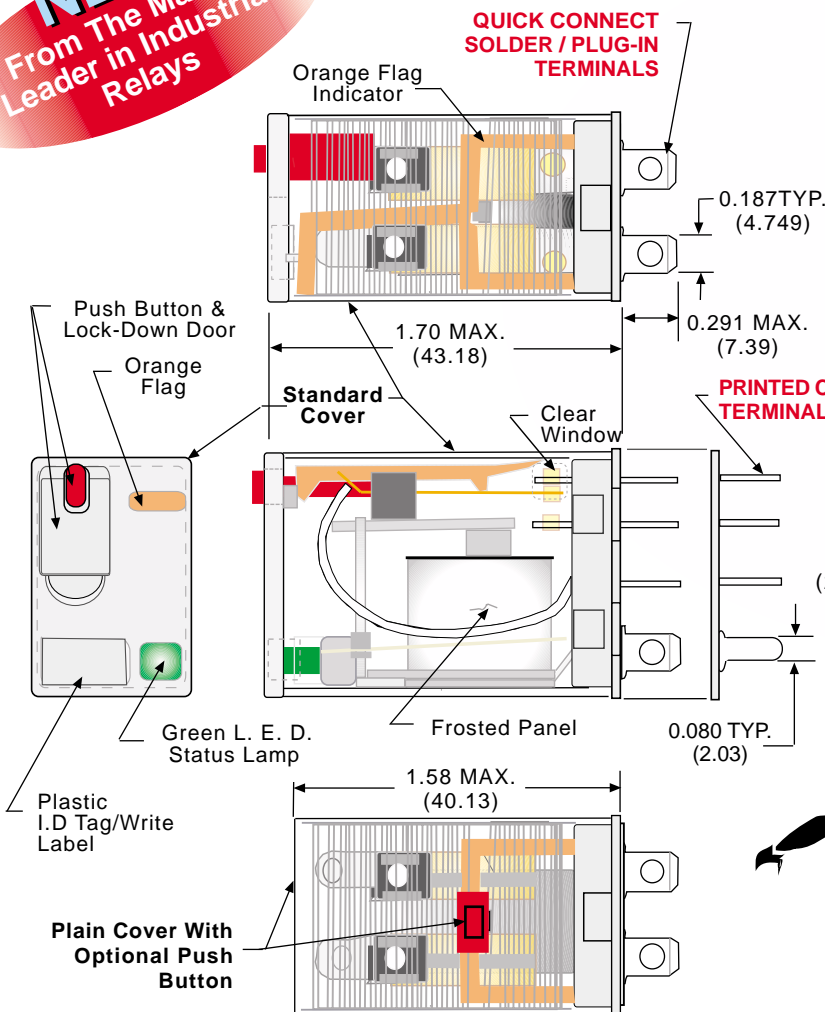

AVAILABLE WITHOUT  
LOCK-DOWN DOOR: CODE "M"



**BI - POLAR  
L.E.D. STATUS LAMP  
ALLOWS FOR REVERSE  
POLARITY APPLICATIONS**

**ORDERING CODE FOR RELAYS**

**CLASS:** 782

**CONTACT CONFIGURATION:** XBX  
DPDT: XBX

**TERMINAL STYLE:** M4L  
QUICK CONNECTSOLDER/  
PLUG-IN TERMINALS: **NO CODE**  
PRINTED CIRCUIT TERMINALS: **CODE T**

**OPTIONAL PLAIN COVER:** -120A  
**CODE C**

**STANDARD COVER FEATURES:**  
PUSH BUTTON & LOCK-DOWN DOOR: **CODE M4**  
BI - POLAR L.E.D. STATUS LAMP: **CODE L**

**OPTIONAL STANDARD COVER DELETION:**  
PUSH BUTTON AND BI - POLAR L.E.D. WITHOUT  
LOCK-DOWN DOOR: **CODE ML**

**OPTIONAL PLAIN COVER FEATURES:**  
PUSH BUTTON WITHOUT LOCK-DOWN DOOR: **CODE M**  
BI - POLAR L.E.D. STATUS LAMP: **CODE L**

**COIL VOLTAGE:** 120  
6, 12, 24, 120, 220/230, 240 ADD "A" FOR AC COILS  
6, 12, 24, 48, 110 ADD "D" FOR DC COILS

**WIRING DIAGRAM**  
(VIEWED FROM PIN END)

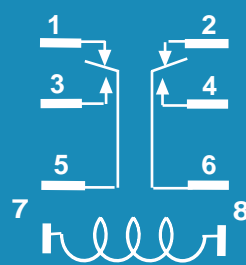

STANDARD PART NUMBERS DPDT	COIL MEASURED @ 25°C	
	NOMINAL INPUT VOLTAGE	NOMINAL RESISTANCE (OHMS)
<b>AC OPERATED - SOLDER/PLUG-IN, 15 AMP</b>		
782XBXM4L-24A	24 VAC, 50/60Hz	72 Ω
782XBXM4L-120A	120 VAC, 50/60Hz	1,700 Ω
782XBXM4L-240A	240 VAC, 50/60HZ	9,100 Ω
<b>DC OPERATED - SOLDER/PLUG-IN, 15 AMP</b>		
782XBXM4L-12D	12 VDC	120 Ω
782XBXM4L-24D	24 VDC	470 Ω
782XBXM4L-110D	110 VDC	10,000 Ω

RETROFITS SCHRACK PT.  
SEE END OF SECTION 1 FOR CROSS REFERENCE

**3PDT, 15 AMPS**

**UL** us  
UL Recognized  
File No. E43641

**SP** LR40787

**UL** LISTED 367G  
IND. CONT. EQ.  
C US  
WHEN USED WITH  
SOCKETS 70-783D-1,

CURRENT LIMITED TO  
RATING OF RELAY OR  
SOCKET WHICHEVER  
IS LESS

**FEATURES**

**BENEFITS**

<b>FLAG INDICATOR:</b>	SHOWS RELAY STATUS IN MANUAL OR POWERED CONDITION.
<b>BI - POLAR</b>	SHOWS COIL "ON" OR "OFF" STATUS. IDEAL IN LOW LIGHT CONDITIONS.
<b>L.E.D. STATUS LAMP:</b>	ALLOWS FOR MANUAL OPERATION OF RELAY WITHOUT THE NEED FOR COIL
<b>PUSH BUTTON:</b>	POWER. IDEAL FOR FIELD SERVICE PERSONNEL TO TEST CONTROL CIRCUITS.
<b>LOCK-DOWN DOOR:</b>	WHEN ACTIVATED, HOLDS PUSH BUTTON AND CONTACTS IN THE OPERATE
<b>FINGER-GRIP COVER:</b>	POSITION. EXCELLENT FOR ANALYZING CIRCUIT PROBLEMS.
<b>I.D. TAG/WRITE LABEL:</b>	ALLOWS OPERATOR TO REMOVE RELAYS FROM SOCKETS MORE EASILY
<b>COVER ADAPTERS:</b>	THAN CONVENTIONAL RELAYS.
	USED FOR IDENTIFICATION OF RELAYS IN MULTI-RELAY CIRCUITS.
	DIN RAIL FLANGE ADAPTER OR TOP/BOTTOM FLANGE ADAPTER, ALLOWS
	THE 783 RELAY TO BE DIRECT MOUNTED TO A DIN RAIL OR PANEL.

**GENERAL SPECIFICATIONS**

**COIL**

Pull-in Voltage:	75% of nominal voltage or less for DC coils, 80% of nominal voltage or less for AC coils
Dropout Voltage:	DC-10%, AC- 30% of nominal voltage or more
Max. Voltage:	110%
Resistance:	±15% measured @ 25°C
Coil Power:	1.5 watts DC, 1.7 VA (60Hz) AC @ 25°C
Insulation System:	Class "B" (130°C per UL standard 1446)
Max. Coil Dissipation:	3.0 watts DC, 3.4 VA (60Hz) AC. @ 25°C
Duty:	Continuous

**CONTACTS**

Contact Material:	Solid silver alloy, gold flashed
Contact Rating:	15 amps @ 110/120 VAC 50/60Hz (30 amps max.) 12 amps @ 28 VDC (30 amps max.) 12 amps @ 220/277 VAC 50/60Hz ( 20 amps max.) 1/2Hp @ 120 VAC, 3/4 Hp @ 250 VAC, B300 pilot duty
Contact Resistance:	50 milliohms maximum initial resistance

**DIELECTRIC STRENGTH**

Contacts to Coil:	2500 V rms
Across open Contacts:	1000 V rms
Pole to Pole:	2500 V rms
Contacts to Frame:	2500 V rms
Insulation Resistance:	100 megohms min. @ 500 VDC

**TEMPERATURE**

Operating:	-30°C to +70°C
Storage:	-30°C to +105°C

**VIBRATION RESISTANCE**

Functional:	6 g's, 10 to 55 Hz (0.6 mm double amplitude)
-------------	--

**SHOCK RESISTANCE**

Functional:	10 g's
-------------	--------

**LIFE EXPECTANCY**

Electrical:	150,000 operations @ rated resistive load
Mechanical:	10,000,000 operations @ no load

**MISCELLANEOUS**

Operating Position:	Any
Insulation Material:	Molded plastic
Enclosure:	Polycarbonate dust cover
Weight:	60 grams approx.



STANDARD COVER



STANDARD COVER WITH  
FLANGE ADAPTER 16-783C1  
ON TOP

**TOP OR BOTTOM FLANGE  
ADAPTER ORDERED AND  
SHIPPED SEPARATELY**



STANDARD COVER WITH  
FLANGE ADAPTER 16-783C1  
ON BOTTOM

**TOP OR BOTTOM FLANGE  
ADAPTER ORDERED AND  
SHIPPED SEPARATELY**



STANDARD COVER  
WITH DIN ADAPTER  
16-783C

**DIN ADAPTER ORDERED AND  
SHIPPED SEPARATELY**

**Mating Sockets**  
**70-783D-1: SCREW/DIN**  
See section 8, page 21



**NEW**  
From The Market  
Leader in Industrial  
Relays

**OUTLINE DIMENSIONS**  
DIMENSIONS SHOWN IN INCHES & (MILLIMETERS).

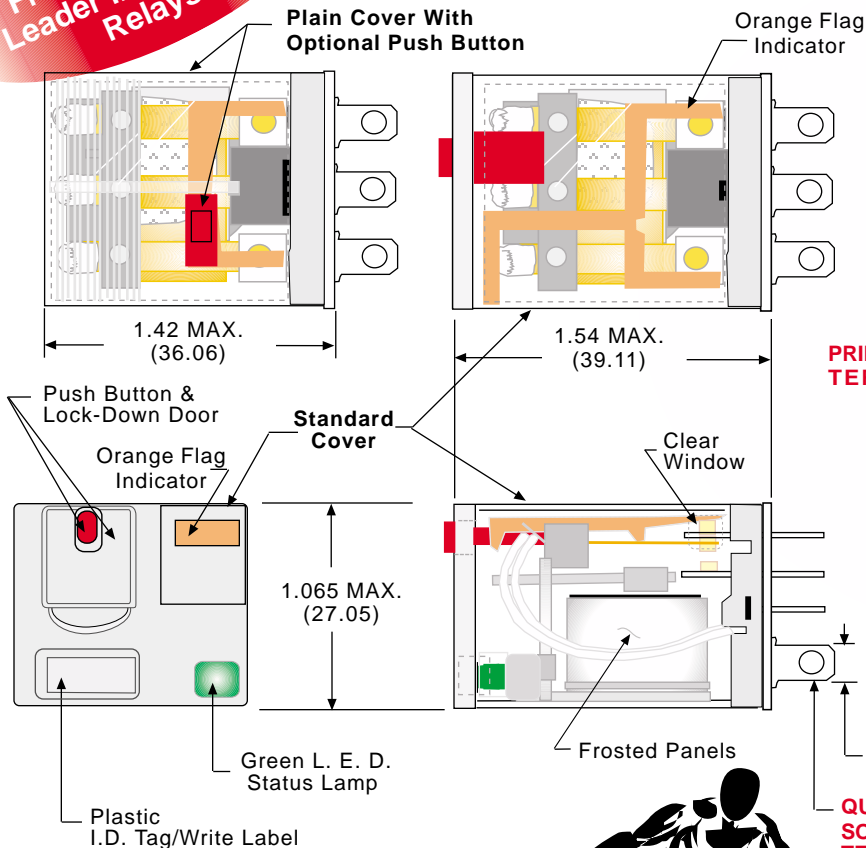

**PRINTED CIRCUIT TERMINALS**

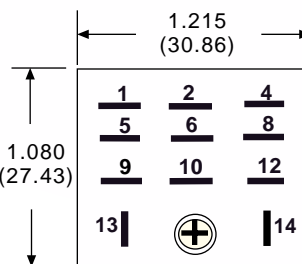
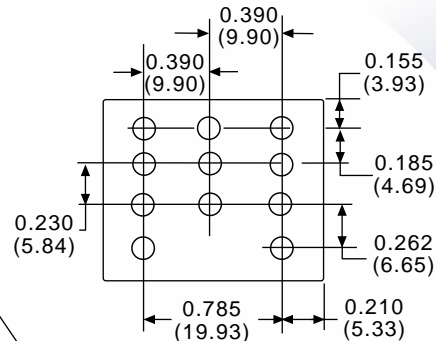

AVAILABLE WITHOUT  
LOCK-DOWN DOOR: CODE "M"

**QUICK CONNECT  
SOLDER / PLUG-IN  
TERMINALS**



BI - POLAR  
L.E.D. STATUS LAMP  
ALLOWS FOR REVERSE  
POLARITY APPLICATIONS

**WIRING DIAGRAM**  
(VIEWED FROM PIN END)

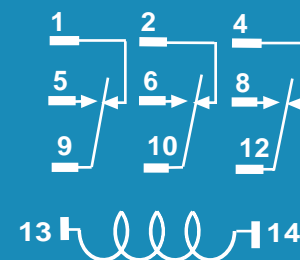

**ORDERING CODE FOR RELAYS**

**783**    **XCX**    **M4L**    **-120A**

**CLASS:** \_\_\_\_\_

**CONTACT CONFIGURATION:** \_\_\_\_\_  
3PDT: XCX

**TERMINAL STYLE:** \_\_\_\_\_  
QUICK CONNECT SOLDER / PLUG-IN TERMINALS: NO CODE  
PRINTED CIRCUIT TERMINALS: CODE T

**OPTIONAL PLAIN COVER:** \_\_\_\_\_  
CODE C \_\_\_\_\_

**STANDARD COVER FEATURES:** \_\_\_\_\_  
PUSH BUTTON & LOCK-DOWN DOOR: CODE M4  
BI - POLAR L.E.D. STATUS LAMP: CODE L

**OPTIONAL STANDARD COVER DELETION:** \_\_\_\_\_  
PUSH BUTTON AND BI - POLAR L.E.D. WITHOUT  
LOCK-DOWN DOOR: CODE ML

**OPTIONAL PLAIN COVER FEATURES:** \_\_\_\_\_  
PUSH BUTTON WITHOUT LOCK-DOWN DOOR: CODE M  
BI - POLAR L.E.D. STATUS LAMP: CODE L

**COIL VOLTAGE:** \_\_\_\_\_  
6, 12, 24, 120, 220/230, 240 ADD "A" FOR AC COILS  
6, 12, 24, 48, 110 ADD "D" FOR DC COILS

**COIL MEASURED @ 25°C**

STANDARD PART NUMBERS	PLAIN COVER	NOMINAL INPUT VOLTAGE	NOMINAL RESISTANCE (OHMS)
<b>AC OPERATED - SOLDER/PLUG-IN, 15 AMP</b>			
783XCXM4L-24A	783XCXC-24A	24 VAC, 50/60 Hz	84.5 Ω
783XCXM4L-120A	783XCXC-120A	120 VAC, 50/60 Hz	2220 Ω
783XCXM4L-240A		240 VAC, 50/60 Hz	9120 Ω
<b>DC OPERATED - SOLDER/PLUG-IN, 15 AMP</b>			
783XCXM4L-12D		12 VDC	96 Ω
783XCXM4L-24D	783XCXC-24D	24 VDC	380 Ω
783XCXM4L-110D		110 VDC	7340 Ω
<b>AC OPERATED - PRINTED CIRCUIT, 15 AMP</b>			
783XCXTM4L-120A		120 VAC, 50/60 Hz	2220 Ω
<b>DC OPERATED - PRINTED CIRCUIT, 15 AMP</b>			
783XCXTM4L-12D		12 VDC	96 Ω
783XCXTM4L-24D		24 VDC	388 Ω

**4PDT, 15 AMPS**

**FEATURES**

**BENEFITS**

<b>FLAG INDICATOR:</b>	SHOWS RELAY STATUS IN MANUAL OR POWERED CONDITION.
<b>BI - POLAR</b>	SHOWS COIL "ON" OR "OFF" STATUS. IDEAL IN LOW LIGHT CONDITIONS.
<b>L.E.D. STATUS LAMP:</b>	ALLOWS FOR MANUAL OPERATION OF RELAY WITHOUT THE NEED FOR COIL POWER.
<b>PUSH BUTTON:</b>	IDEAL FOR FIELD SERVICE PERSONNEL TO TEST CONTROL CIRCUITS.
<b>LOCK-DOWN DOOR:</b>	WHEN ACTIVATED, HOLDS PUSH BUTTON AND CONTACTS IN THE OPERATE POSITION. EXCELLENT FOR ANALYZING CIRCUIT PROBLEMS.
<b>FINGER-GRIP COVER:</b>	ALLOWS OPERATOR TO REMOVE RELAYS FROM SOCKETS MORE EASILY THAN CONVENTIONAL RELAYS.
<b>I.D. TAG/WRITE LABEL:</b>	USED FOR IDENTIFICATION OF RELAYS IN MULTI-RELAY CIRCUITS.
<b>COVER ADAPTERS:</b>	DIN RAIL FLANGE ADAPTER OR TOP/BOTTOM FLANGE ADAPTER, ALLOWS THE 784 RELAY TO BE DIRECT MOUNTED TO A DIN RAIL OR PANEL.

**UL** **us** LR40787  
 UL Recognized  
 File No. E43641

**UL** LISTED 367G  
 IND. CONT. EQ.

**C** **US**  
 WHEN USED WITH  
 SOCKETS 70-784D-1,

CURRENT LIMITED TO  
 RATING OF RELAY OR  
 SOCKET WHICHEVER  
 IS LESS

**GENERAL SPECIFICATIONS**

**COIL**

Pull-in Voltage:	75% of nominal voltage or less for DC coils, 80% of nominal voltage or less for AC coils
Dropout Voltage:	DC-10%, AC- 30% of nominal voltage or more
Max. Voltage:	110%
Resistance:	±10% measured @ 25°C
Coil Power:	1.5 watts DC, 2.0 VA (60Hz) AC @ 25°C (4PDT)
Insulation System:	Class "B" (130°C per UL standard 1446)
Max. Coil Dissipation:	3.0 watts DC, 3.4 VA (60Hz) AC. @ 25°C
Duty:	Continuous.

**CONTACTS**

Contact Material:	Solid silver alloy, gold flashed
Contact Rating:	15 amps @ 110/120 VAC 50/60Hz, (30 amps max.) 12 amps @ 28 VDC (30 amps max.) 12 amps @ 220/277 VAC 50/60Hz ( 20 amps max.) 1/2Hp @ 120 VAC, 3/4 Hp @ 250 VAC. B300 pilot duty
Contact Resistance:	50 milliohms maximum initial resistance

**DIELECTRIC STRENGTH**

Contacts to Coil:	2500 V rms
Across Open Contacts:	1000 V rms
Pole to Pole:	2500 V rms
Contacts to Frame:	2500 V rms
Insulation Resistance:	100 megohms min. @ 500 VDC

**TEMPERATURE**

Operating:	-30°C to +70°C
Storage:	-30°C to +105°C

**VIBRATION RESISTANCE**

Functional:	6 g's, 10 to 55 Hz (0.6 mm double amplitude)
-------------	--

**SHOCK RESISTANCE**

Functional:	10 g's
-------------	--------

**LIFE EXPECTANCY**

Electrical:	150,000 operations @ rated resistive load
Mechanical:	10,000,000 operations @ no load

**MISCELLANEOUS**

Operating Position:	Any
Insulation Material:	Molded plastic
Enclosure:	Polycarbonate dust cover
Weight:	80 grams approx.



STANDARD COVER



STANDARD COVER WITH  
 FLANGE ADAPTER 16-784C1  
 ON TOP 16-784C1



STANDARD COVER WITH  
 FLANGE ADAPTER 16-784C1  
 ON BOTTOM



STANDARD COVER  
 WITH DIN ADAPTER  
 16-784C

**TOP OR BOTTOM FLANGE  
 ADAPTER ORDERED AND  
 SHIPPED SEPARATELY**

**Mating Sockets**  
**70-784D-1: SCREW/DIN**  
 See section, 8 page 22



**4PDT, 15 AMPS**

**NEW**  
From The Market  
Leader in Industrial  
Relays

**OUTLINE DIMENSIONS**  
DIMENSIONS SHOWN IN INCHES & (MILLIMETERS).

**PRINTED CIRCUIT  
MOUNTING HOLE LAYOUT**  
(BOTTOM VIEW)

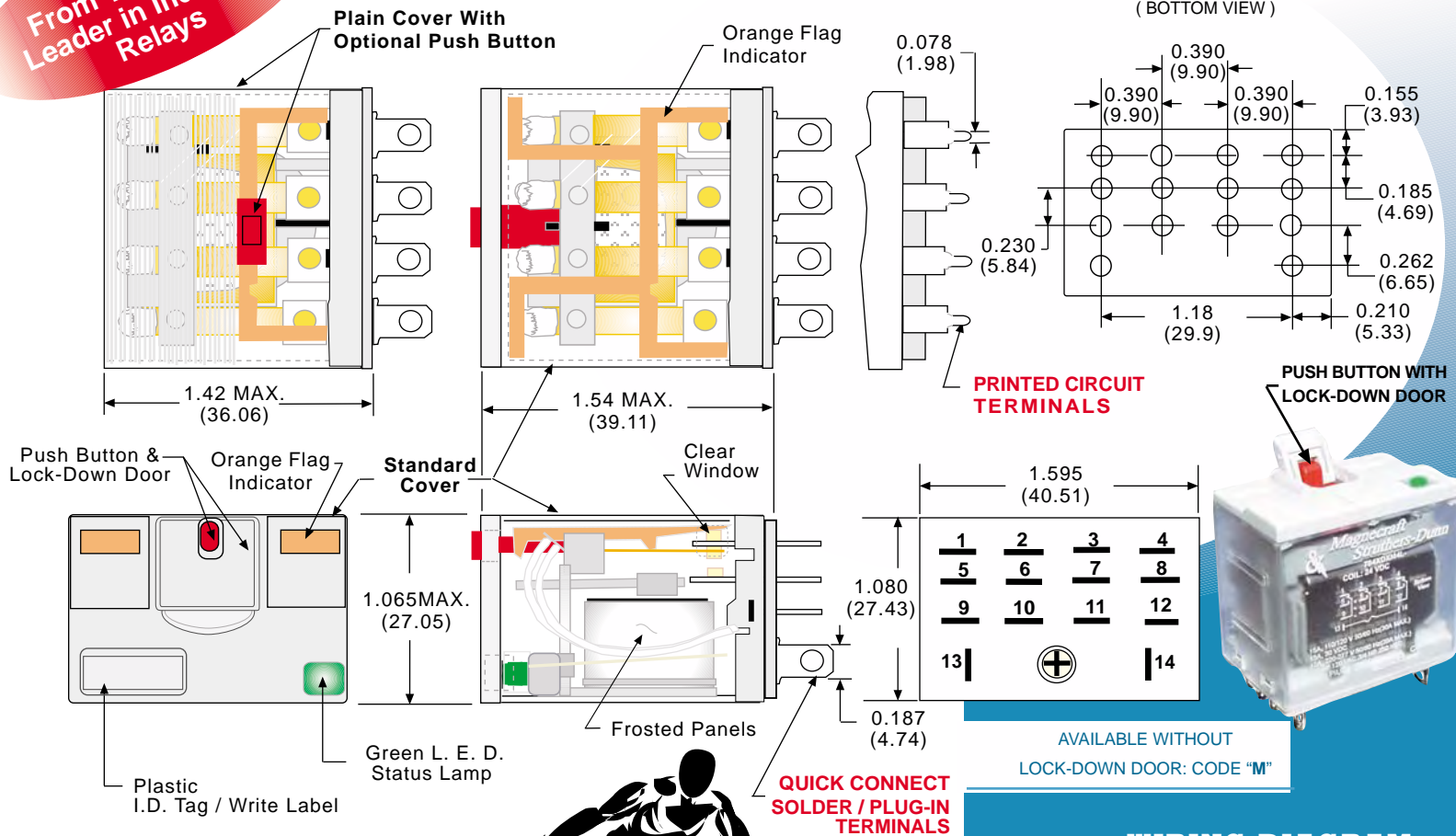

**QUICK CONNECT  
SOLDER / PLUG-IN  
TERMINALS**

**BI - POLAR  
L.E.D. STATUS LAMP  
ALLOWS FOR REVERSE  
POLARITY APPLICATIONS**

**WIRING DIAGRAM**  
(VIEWED FROM PIN END)

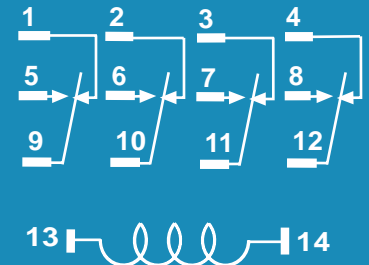

**ORDERING CODE FOR RELAYS**

**CLASS:** 784

**CONTACT CONFIGURATION:** XDX

**TERMINAL STYLE:** M4L

QUICK CONNECT SOLDER / PLUG-IN TERMINALS: **NO CODE**  
PRINTED CIRCUIT TERMINALS: **CODE T**

**OPTIONAL PLAIN COVER:** -120A

**CODE C**

**STANDARD COVER FEATURES:**

PUSH BUTTON & LOCK-DOWN DOOR: **CODE M4**  
L.E.D. STATUS LAMP: **CODE L**

**OPTIONAL STANDARD COVER DELETION:**

PUSH BUTTON AND L.E.D. WITHOUT LOCK-DOWN DOOR: **CODE ML**

**OPTIONAL PLAIN COVER FEATURES:**

PUSH BUTTON WITHOUT LOCK-DOWN DOOR: **CODE M**  
L.E.D. STATUS LAMP: **CODE L**

**COIL VOLTAGE:**

6, 12, 24, 120, 220/230, 240 ADD "A" FOR AC COILS  
6, 12, 24, 48, 110 ADD "D" FOR DC COILS

STANDARD PART NUMBERS	COIL MEASURED @ 25°C		
	PLAIN COVER	NOMINAL INPUT VOLTAGE	NOMINAL RESISTANCE (OHMS)
<b>AC OPERATED - SOLDER/PLUG-IN, 15 AMP</b>			
784XDXM4L-24A	784DXC-24A	24 VAC, 50/60 Hz	84.5 Ω
784XDXM4L-120A	784DXC-120A	120 VAC, 50/60 Hz	2220 Ω
784XDXM4L-240A		240 VAC, 50/60 Hz	9120 Ω
<b>DC OPERATED - SOLDER/PLUG-IN, 15 AMP</b>			
784XDXM4L-12D		12 VDC	96 Ω
784XDXM4L-24D	784DXC-24D	24 VDC	380 Ω
784XDXM4L-110D		110 VDC	7340 Ω
<b>AC OPERATED - PRINTED CIRCUIT, 15 AMP</b>			
784XDXTM4L-120A		120 VAC, 50/60 Hz	2220 Ω
<b>DC OPERATED - PRINTED CIRCUIT, 15 AMP</b>			
784XDXTM4L-12D		12 VDC	96 Ω
784XDXTM4L-24D		24 VDC	388 Ω

**GENERAL SPECIFICATIONS**

<b>COIL</b>	
Pull-in Voltage :	75% of nominal voltage or less for DC coils, 80% of nominal voltage or less for AC coils
Dropout Voltage:	DC-10%. AC-30%. Of nominal voltage or more
Max. Voltage :	110%
Resistance:	±15% measured @ 25°C
Coil Power:	0.9 to 1.1 watts DC., 1.0 to 1.2 VA (60Hz) AC. @ 25°C
Insulation System:	Class "B" (130°C per UL standard 1446)
Max. Coil Dissipation:	2.3 watts DC, 2.55 VA (60Hz) AC. 5 minutes max. @ 40°C
Duty:	Continuous

**CONTACTS**

Contact Material:	3 amps bifurcated silver gold plated, 3 amps silver gold flashed, 5 & 15 amps silver alloy, gold flashed
Contact Rating:	<b>SPDT:</b> 15 amps @ 120/240 VAC, 30 VDC. 1/3 Hp, 120 VAC. 1/2 Hp 240 VAC, B300 pilot duty <b>DPDT:</b> 15 amps @ 120/240 VAC, 10 amps @ 30 VDC, 10 amps @ 120/240 VAC, G.P. 1/3 Hp, 120 VAC. 1/2Hp 240 VAC, B300 pilot duty <b>4PDT:</b> Bifurcated 3 amps @ 120/240 VAC, 30 VDC. 1/16 Hp (2.8 amps FLA), 120 VAC. Pilot duty - 5 amps make, 1/2 amps break, 3 amps continuous, 120 VAC. <b>4PDT:</b> 3 amps @ 120 VAC, 30 VDC 1/10 Hp 120/240 VAC, C300 pilot duty <b>4PDT:</b> 5 amps @ 120/240 VAC, 30 VDC 1/6 Hp 120/240 VAC, C300 pilot duty

**DIELECTRIC STRENGTH**

Coil to Frame:	1500 V rms
Across Open Contacts:	1000 V rms
Contacts to Frame:	1500 V rms
Insulation Resistance:	100 megohms @ 500 VDC

**TEMPERATURE**

Operating:	-40°C to +70°C
Storage:	-40°C to +105°C

**VIBRATION RESISTANCE**

Functional:	5 g, 10 to 55Hz; 1 mm (double amplitude)
-------------	--

**SHOCK RESISTANCE**

Functional:	20 g
Mechanical:	100 g

**LIFE EXPECTANCY**

Electrical:	200,000 operations @ rated resistive load
Mechanical:	10,000,000 operations @ no load

**MISCELLANEOUS**

Operating Position:	Any
Insulation Material:	Molded plastic
Enclosure:	Polycarbonate dust cover
Weight:	SPDT & DPDT 35 grams approx.

**SPDT, DPDT & 4PDT,  
3, 5 & 15 AMPS**

UL Recognized  
File No. E52197

**LISTED 367G  
IND. CONT. EQ.**  
C US  
WHEN USED WITH  
SOCKETS  
70-459-1 OR 70-461-1

CURRENT LIMITED TO  
RATING OF RELAY OR  
SOCKET WHICHEVER  
IS LESS



COMPLIES WITH REQUIREMENTS OF

\* IEC STANDARDS 947-4-1 AND  
947-5-1 LOW VOLTAGE DIRECTIVE

\* IEC = INTERNATIONAL  
ELECTROTECHNICAL COMMISSION

\* CE TESTING AND EVALUATION  
PERFORMED BY THE UNDERWRITERS  
LABORATORIES AS A THIRD PARTY  
PARTICIPANT

**MANUFACTURED UNDER  
ISO 9002 & QS 9000**



**4PDT, QUICK CONNECT  
SOLDER/PLUG-IN  
3 OR 5 AMP**



**4PDT, PRINTED CIRCUIT  
3 OR 5 AMP**



**SPDT, DPDT, QUICK CONNECT  
SOLDER/PLUG-IN 15 AMP**



**SPDT, DPDT, PRINTED CIRCUIT  
15 AMP**

**Mating Sockets**  
70-782D-1, 70-459-1, 70-461-1:  
**SCREW/DIN**  
70-401-1, 70-378-1: **SOLDER**  
70-402-1, 70-379-1:  
**PRINTED CIRCUIT**

See section 8, page 13, 14, 15, 20



**SPDT, 15 AMPS**

**OUTLINE DIMENSIONS**  
DIMENSIONS SHOWN IN INCHES & (MILLIMETERS).

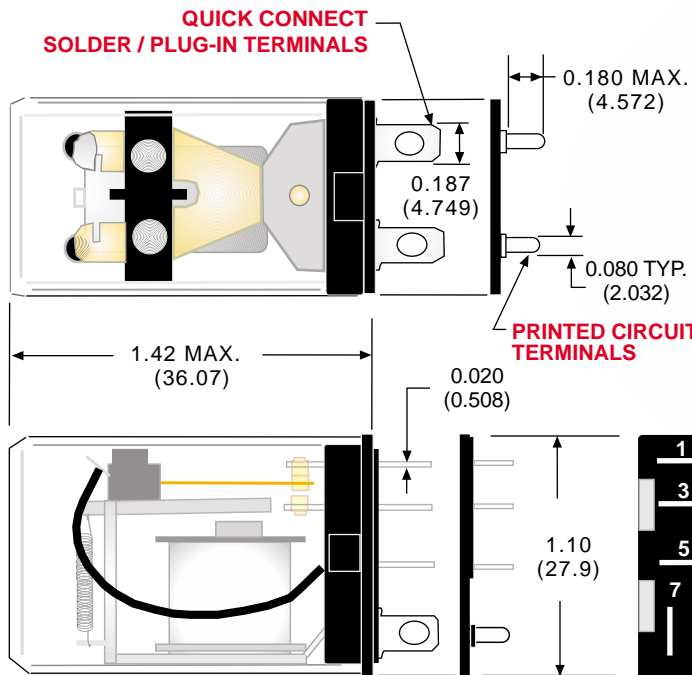

**PRINTED CIRCUIT MOUNTING HOLE LAYOUT**  
(BOTTOM VIEW)

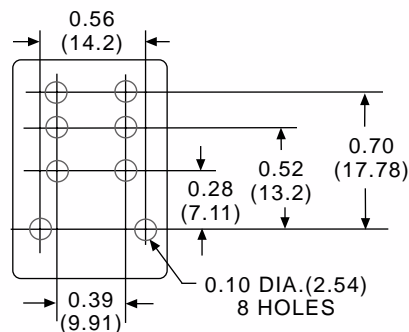

**DIN ADAPTER 16-782C**



**FLANGE ADAPTER 16-782C1**



NEW SLOTTED PLAIN COVER, ALLOWS FOR INSTALLATION OF THE OPTIONAL TOP MOUNT DIN OR TOP/BOTTOM MOUNT FLANGE ADAPTERS. ADAPTERS SOLD SEPARATELY



**OBSERVE POLARITY WHEN L.E.D. STATUS LAMP IS INSTALLED ACROSS COIL (DC STYLES TYPICAL)**

**WIRING DIAGRAMS**  
(VIEWED FROM PIN END)

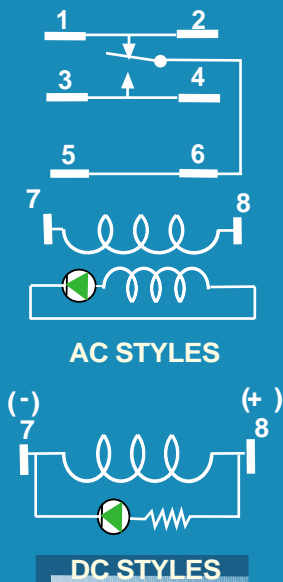

STANDARD PART NUMBERS SPDT	COIL MEASURED @ 25°C	
	NOMINAL INPUT VOLTAGE	NOMINAL RESISTANCE (OHMS)
<b>AC OPERATED - SOLDER/PLUG-IN, 15 AMP</b>		
W78ARCSX-108	12 VAC, 50/60 Hz	46 Ω
W78ARCSX-109	24VAC, 50/60 Hz	180 Ω
W78ARCSX-111	120 VAC, 50/60 Hz	4430 Ω
W78ARCSX-112	240 VAC, 50/60 Hz	15,700 Ω
<b>AC OPERATED - SOLDER/PLUG-IN WITH INDICATOR LAMP, 15 AMP</b>		
W78ARNCSX-8	24 VAC, 50/60 Hz	180 Ω
W78ARNCSX-9	120VAC, 50/60 Hz	4430 Ω
W78ARNCSX-10	240 VAC, 50/60 Hz	15,700 Ω
<b>DC OPERATED - SOLDER/PLUG-IN, 15 AMP</b>		
W78RCSX-96	6 VDC	40 Ω
W78RCSX-97	12 VDC	160 Ω
W78RCSX-98	24VDC	650 Ω
W78RCSX-100	110 VDC	11,000 Ω
<b>DC OPERATED - SOLDER/PLUG-IN WITH INDICATOR LAMP, 15 AMP</b>		
W78RNCSX-10	24 VDC	650 Ω
<b>AC OPERATED - PRINTED CIRCUIT TERMINAL, 15 AMP</b>		
W78ARPCX-81	12 VAC	46 Ω
W78ARPCX-82	24 VAC	180 Ω
W78ARPCX-84	120 VAC	4430 Ω
<b>DC OPERATED - PRINTED CIRCUIT TERMINAL, 15 AMP</b>		
W78RPCX-79	12 VDC	160 Ω
W78RPCX-83	24 VDC	650 Ω
W78RPCX-85	110 VDC	11,000 Ω

**DPDT, 15 AMPS**

**OUTLINE DIMENSIONS**  
DIMENSIONS SHOWN IN INCHES & (MILLIMETERS).

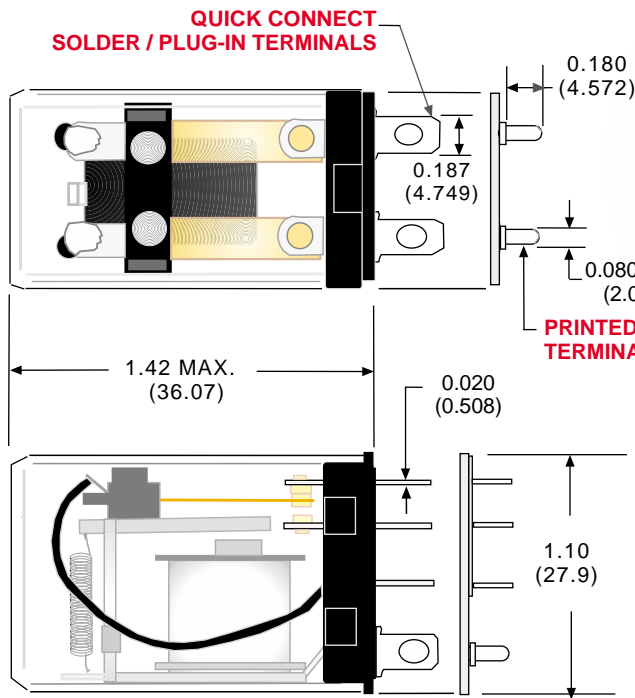

**PRINTED CIRCUIT MOUNTING HOLE LAYOUT**  
(BOTTOM VIEW)

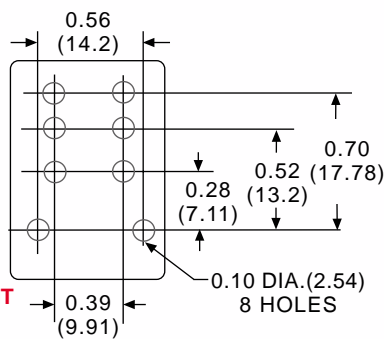

**PRINTED CIRCUIT TERMINALS**

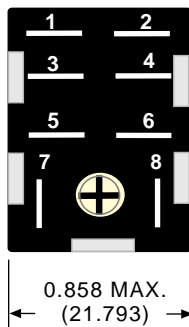

**DIN ADAPTER 16-782C**



**FLANGE ADAPTER 16-782C1**

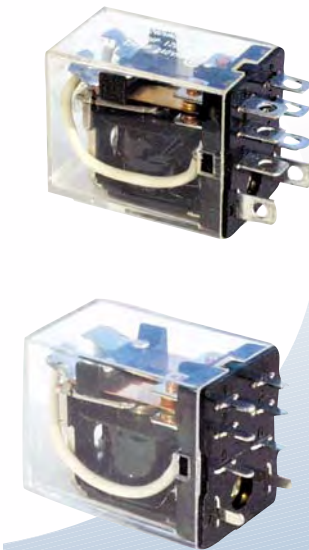

NEW SLOTTED PLAIN COVER, ALLOWS FOR INSTALLATION OF THE OPTIONAL TOP MOUNT DIN OR TOP/BOTTOM MOUNT FLANGE ADAPTERS. ADAPTERS SOLD SEPARATELY



SEE CLASS 782XBX FOR PART NUMBERS WITH L.E.D. STATUS LAMP AND PUSH BUTTON

**WIRING DIAGRAM**  
(VIEWED FROM PIN END)

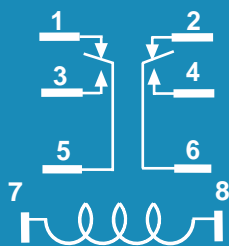

**COIL MEASURED @ 25°C**

STANDARD PART NUMBERS DPDT	NOMINAL INPUT VOLTAGE	NOMINAL RESISTANCE (OHMS)
<b>AC OPERATED - SOLDER/PLUG-IN, 15 AMP</b>		
W78ARCSX-7	6 VAC, 50/60 Hz	12.2 Ω
W78ARCSX-9	24VAC, 50/60 Hz	180 Ω
W78ARCSX-11	120 VAC, 50/60 Hz	4430 Ω
W78ARCSX-12	240 VAC, 50/60 Hz	15,700 Ω
<b>DC OPERATED - SOLDER/PLUG-IN, 15 AMP</b>		
W78RCSX-6	6 VDC	40 Ω
W78RCSX-7	12 VDC	160 Ω
W78RCSX-8	24VDC	650 Ω
W78RCSX-9	48 VDC	2,600 Ω
W78RCSX-10	110 VDC	11,000 Ω
<b>AC OPERATED - PRINTED CIRCUIT TERMINAL, 15 AMP</b>		
W78ARPCX-5	120 VAC, 50/60 Hz	4430 Ω
W78ARPCX-6	240 VAC, 50/60 Hz	15,700 Ω
<b>DC OPERATED - PRINTED CIRCUIT TERMINAL, 15 AMP</b>		
W78RPCX-1	6VDC	40 Ω
W78RPCX-2	12 VDC	160 Ω
W78RPCX-3	24 VDC	650 Ω

RETROFITS POTTER & BRUMFIELD K10.  
SEE END OF SECTION 1 FOR CROSS REFERENCE



**4PDT, 3 & 5 AMPS**

**OUTLINE DIMENSIONS**  
DIMENSIONS SHOWN IN INCHES & (MILLIMETERS).

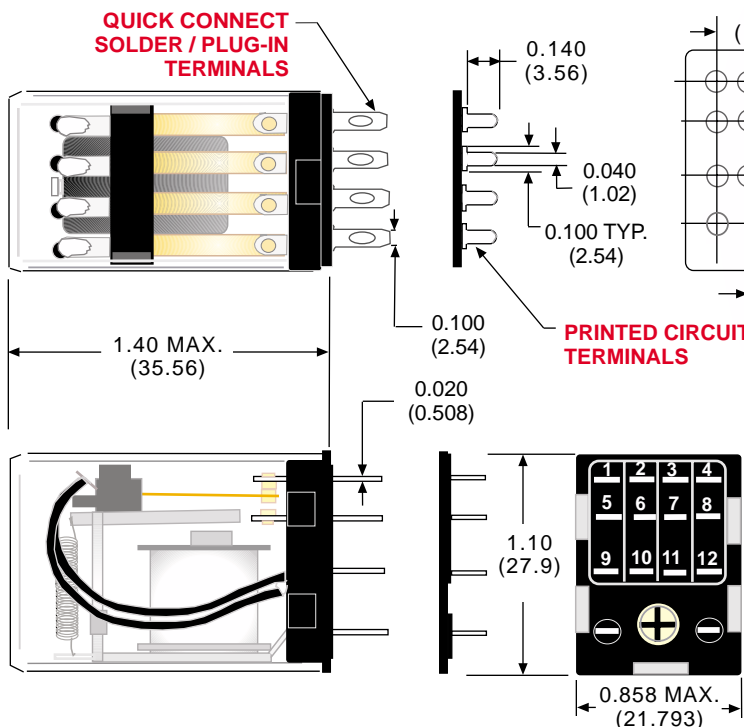

**DIN ADAPTER 16-782C**



**FLANGE ADAPTER 16-782C1**



NEW SLOTTED PLAIN COVER, ALLOWS FOR INSTALLATION OF THE OPTIONAL TOP MOUNT DIN OR TOP/BOTTOM MOUNT FLANGE ADAPTERS. ADAPTERS SOLD SEPARATELY



SEE CLASS 782XDX FOR PART NUMBERS WITH L.E.D. STATUS LAMP AND PUSH BUTTON

**ALL 4 POLE RELAYS HAVE OPPOSITE POLARITY ARC BARRIERS AS A STANDARD FEATURE TO PROVIDE GREATER VOLTAGE PROTECTION BETWEEN ADJACENT POLES**

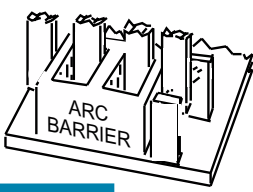

**WIRING DIAGRAM (VIEWED FROM PIN END)**

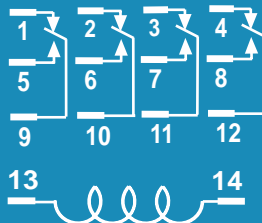

**COIL MEASURED @ 25°C**

STANDARD PART NUMBERS 4PDT	NOMINAL INPUT VOLTAGE	NOMINAL RESISTANCE (OHMS)
<b>AC OPERATED - SOLDER/PLUG-IN, 3 AMP, BIFURCATED</b>		
W78ATCSX-2	12 VAC, 50/60 Hz	46 Ω
W78ATCSX-3	24 VAC, 50/60 Hz	180 Ω
W78ATCSX-5	120 VAC, 50/60 Hz	4430 Ω
W78ATCSX-6	240 VAC, 50/60 Hz	15,700 Ω
<b>DC OPERATED - SOLDER/PLUG-IN, 3 AMP, BIFURCATED</b>		
W78TCSX-1	6 VDC	40 Ω
W78TCSX-2	12 VDC	160 Ω
W78TCSX-3	24 VDC	650 Ω
W78TCSX-5	110 VDC	11,000 Ω
<b>AC OPERATED - SOLDER/PLUG-IN, 3 AMP</b>		
W78ACSX-2	12 VAC, 50/60 Hz	46 Ω
W78ACSX-3	24 VAC, 50/60 Hz	180 Ω
W78ACSX-5	120 VAC, 50/60 Hz	4430 Ω
W78ACSX-6	240 VAC, 50/60 Hz	15,700 Ω
<b>DC OPERATED - SOLDER/PLUG-IN, 3 AMP</b>		
W78CSX-1	6 VDC	40 Ω
W78CSX-2	12 VDC	160 Ω
W78CSX-3	24 VDC	650 Ω
W78CSX-6	110 VDC	11,000 Ω
<b>AC OPERATED PRINTED CIRCUIT, 3 AMP</b>		
W78APCX-3	24 VAC, 50/60 Hz	180 Ω
W78APCX-5	120 VAC, 50/60 Hz	4430 Ω
<b>DC OPERATED PRINTED CIRCUIT, 3 AMP</b>		
W78PCX-2	12 VDC	160 Ω
W78PCX-3	24 VDC	650 Ω
W78PCX-6	110 VDC	11,000 Ω
<b>AC OPERATED - SOLDER/PLUG-IN, 5 AMP</b>		
W78KACSX-15	24 VAC, 50/60 Hz	180 Ω
W78KACSX-17	120 VAC, 50/60 Hz	4430 Ω
W78KACSX-18	240 VAC, 50/60 Hz	15,700 Ω
<b>DC OPERATED - SOLDER/PLUG-IN, 5 AMP</b>		
W78KCSX-12	12 VDC	160 Ω
W78KCSX-13	24 VDC	650 Ω

**FEATURES**

**BENEFITS**

- FLAG INDICATOR:** SHOWS RELAY STATUS IN MANUAL OR POWERED CONDITION.
- BI - POLAR L.E.D. STATUS LAMP:** SHOWS COIL "ON" OR "OFF" STATUS. IDEAL IN LOW LIGHT CONDITIONS.
- PUSH BUTTON:** ALLOWS FOR MANUAL OPERATION OF RELAY WITHOUT THE NEED FOR COIL POWER. IDEAL FOR FIELD SERVICE PERSONNEL TO TEST CONTROL CIRCUITS.
- LOCK-DOWN DOOR:** WHEN ACTIVATED, HOLDS PUSH BUTTON AND CONTACTS IN THE OPERATE POSITION. EXCELLENT FOR ANALYZING CIRCUIT PROBLEMS.
- FINGER-GRIP COVER:** ALLOWS OPERATOR TO REMOVE RELAYS FROM SOCKETS MORE EASILY THAN CONVENTIONAL RELAYS.
- I.D. TAG/WRITE LABEL:** USED FOR IDENTIFICATION OF RELAYS IN MULTI - RELAY CIRCUITS.

**DPDT & 3PDT, 12 AMPS**

**UL** **us** **SA** 40787  
 UL Recognized  
 File No. E43641

**UL** LISTED 367G  
 IND. CONT. EQ.  
**C US**

WHEN USED WITH  
 SOCKETS  
**70-464-1, 70-465-1,**  
**70-750D8-1 OR**  
**70-750D11-1**

CURRENT LIMITED TO  
 RATING OF RELAY OR  
 SOCKET WHICHEVER  
 IS LESS

**CE**  
 COMPLIES WITH REQUIREMENTS OF  
 \* IEC STANDARDS 947-4-1 AND  
 947-5-1 LOW VOLTAGE DIRECTIVE  
 \* IEC = INTERNATIONAL  
 ELECTROTECHNICAL COMMISSION  
 \* CE TESTING AND EVALUATION  
 PERFORMED BY THE UNDERWRITERS  
 LABORATORIES AS A THIRD PARTY  
 PARTICIPANT

**GENERAL SPECIFICATIONS**

**MANUFACTURED UNDER  
 ISO 9002 & QS 9000**

**COIL**

- Pull-in Voltage: 80% of nominal voltage or less for DC coils,  
85% of nominal voltage or less for AC coils
- Dropout Voltage: DC-10%, AC-30% of nominal voltage or more
- Max. Voltage: 110%
- Resistance: ±10% measured @ 25°C
- Coil Power: 1.4 watts DC. 2 VA to 3.55 VA (60Hz) AC. @ 25°C
- Insulation System: Class "B" (130°C per UL standard 1446)
- Max. Coil Dissipation: 3.0 watts DC. 3.4 VA (60Hz) AC. @ 25°C
- Duty: Continuous

**CONTACTS**

- Contact Material: Silver alloy, gold flashed
- Contact Rating: 12 amps, 120 / 240 VAC 50/60Hz, 12 amps, 28 VDC  
1/3Hp 120 VAC, 1/2Hp 240 VAC
- Contact Resistance: 50 milliohms max. @ 10 amps, 120 VAC or 24 VDC  
contacts conditioned for 50 make and break,  
operations @ 1 second "ON" & 1 second "OFF"

**DIELECTRIC STRENGTH**

- Contacts to Coil: 2500 V rms
- Across open Contacts: 1500 V rms
- Pole to Pole: 2500 V rms
- Contacts to Frame: 2500 V rms
- Insulation Resistance: 100 megohms @ 500 VDC

**TEMPERATURE**

- Operating: -40°C to +50°C. (AC), -40°C +65°C. (DC)
- Storage: -40°C to +100°C

**LIFE EXPECTANCY**

- Electrical: 200,000 operations @ rated resistive load
- Mechanical: 5,000,000 operations @ no load

**MISCELLANEOUS**

- Operating Position: Any
- Insulation Material: Molded plastic
- Enclosure: Polycarbonate dust cover
- Weight: 79 grams approx.



**Mating Sockets**  
**70-750D8-1, 70-750D11-1,**  
**70-464-1, 70-465-1: SCREW/DIN**  
**70-169-1, 70-170-1: SCREW/PANEL**  
 See section 8, page 7 - 12



**DPDT & 3PDT, 12 AMPS**

**NEW**  
From The Market  
Leader in Industrial  
Relays

**OUTLINE DIMENSIONS**  
DIMENSIONS SHOWN IN INCHES & (MILLIMETERS).

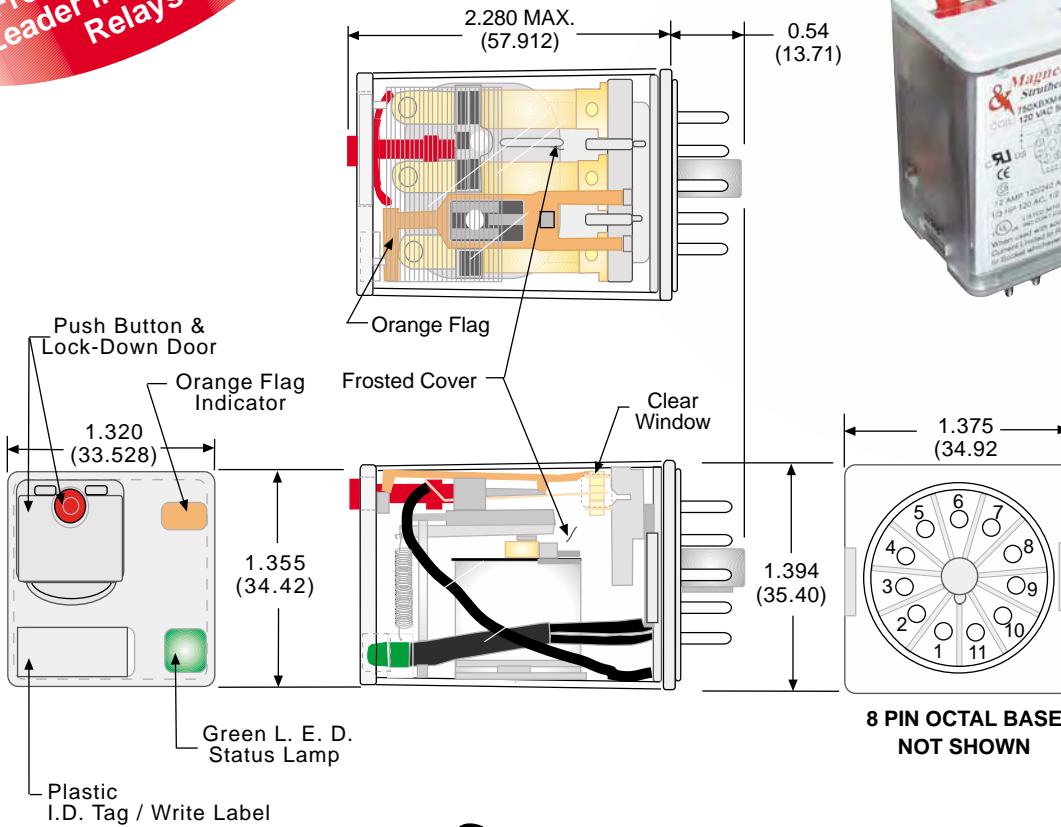

**WIRING DIAGRAMS**  
(VIEWED FROM PIN END)

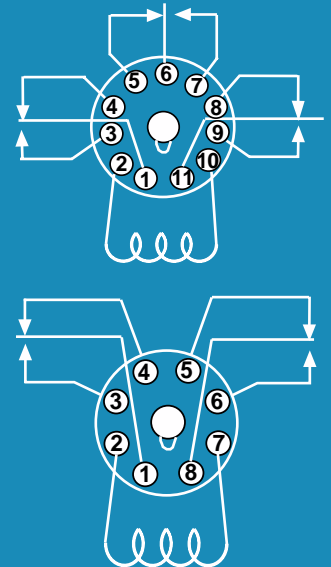

**BI - POLAR  
L.E.D. STATUS LAMP  
ALLOWS FOR REVERSE  
POLARITY APPLICATIONS**

**ORDERING CODE FOR RELAYS**

**750**    **XBX**    **M4L-120A**

**CLASS:** \_\_\_\_\_

**CONTACT CONFIGURATION:** \_\_\_\_\_  
 DPDT: **XBX**  
 3PDT: **XCX**

**STANDARD FEATURES:** \_\_\_\_\_  
 PUSH BUTTON &  
 LOCK DOWN DOOR: **CODE M4**  
 BI - POLAR L.E.D. STATUS LAMP: **CODE L**

**OPTIONAL FEATURES:** \_\_\_\_\_  
 PUSH BUTTON WITHOUT  
 LOCK DOWN DOOR: **CODE M**

**COIL VOLTAGE:** \_\_\_\_\_  
 6, 12, 24, 120, 220/230, 240 ADD "A" FOR AC COILS  
 6, 12, 24, 48, 110 ADD "D" FOR DC COILS

STANDARD PART NUMBERS	CONTACT CONFIGURATION	COIL MEASURED @ 25°C	
		NOMINAL INPUT VOLTAGE	NOMINAL RESISTANCE (OHMS)
<b>AC OPERATED - 8 PIN OCTAL, 12 AMP</b>			
750XBXM4L-24A	DPDT	24 VAC, 50/60Hz	72 Ω
750XBXM4L-120A	DPDT	120 VAC, 50/60Hz	1,700 Ω
750XBXM4L-240A	DPDT	240 VAC, 50/60Hz	9,100 Ω
<b>DC OPERATED - 8 PIN OCTAL, 12 AMP</b>			
750XBXM4L-12D	DPDT	12 VDC	120 Ω
750XBXM4L-24D	DPDT	24 VDC	470 Ω
750XBXM4L-110D	DPDT	110 VDC	10,000 Ω
<b>AC OPERATED - 11 PIN OCTAL, 12 AMP</b>			
750XCXM4L-24A	3PDT	24 VAC, 50/60Hz	72 Ω
750XCXM4L-120A	3PDT	120 VAC, 50/60Hz	1,700 Ω
750XCXM4L-240A	3PDT	240 VAC, 50/60Hz	9,100 Ω
<b>DC OPERATED - 11 PIN OCTAL, 12 AMP</b>			
750XCXM4L-12D	3PDT	12 VDC	120 Ω
750XCXM4L-24D	3PDT	24 VDC	470 Ω
750XCXM4L-110D	3PDT	110 VDC	10,000 Ω

CADMIUM-FREE CONTACTS AVAILABLE,  
CONTACT FACTORY FOR DETAILS

## UL CONTACT LOAD RATINGS TABLE

POLES	CURRENT OR HORSE POWER	LOAD VOLTAGE	LOAD VOLTAGE FREQUENCY	TYPE OF LOAD
2 POLES	12 AMP	120 VAC	DC	RESISTIVE
	10 AMP	240 VAC	50/60 Hz	RESISTIVE
	10 AMP	28 VDC	DC	RESISTIVE
3 POLES	10 AMP	120/240 VAC	50/60 Hz	RESISTIVE
	10 AMP	28 VDC	DC	RESISTIVE
2 & 3 POLES	1/3 HP	120 VAC	50/60 Hz	MOTOR
	1/2 HP	240 VAC	50/60 Hz	MOTOR

## CONTACT RATINGS WITH BLOW-OUT MAGNET FOR DC SWITCHING (NOT UL)

POLES	CURRENT OR HORSE POWER	LOAD VOLTAGE	LOAD VOLTAGE FREQUENCY	TYPE OF LOAD
2 POLES	3 AMP	150 VDC	DC	RESISTIVE

**DPDT & 3PDT  
3, 10 & 12 AMPS**

**UL** us  
UL Recognized  
File No. E 43641

**SP** 168986

**CE**

**UL** LISTED 367G  
IND. CONT. EQ.  
C US

COMPLIES WITH REQUIREMENTS OF

\* IEC STANDARDS 947-4-1 AND 947-5-1 LOW VOLTAGE DIRECTIVE

\* IEC = INTERNATIONAL ELECTROTECHNICAL COMMISSION

\* CE TESTING AND EVALUATION PERFORMED BY THE UNDERWRITERS LABORATORIES AS A THIRD PARTY PARTICIPANT

WHEN USED WITH SOCKETS 70-464-1 OR 70-465-1

CURRENT LIMITED TO RATING OF RELAY OR SOCKET WHICHEVER IS LESS

## GENERAL SPECIFICATIONS

### COIL

- Pull-in Voltage: 80% of nominal voltage or less for DC coils, 85% of nominal voltage or less for AC coils
- Dropout Voltage: DC-10%, AC-30% of nominal voltage or more
- Max. Voltage: 110%
- Resistance: ±10% measured @ 25°C
- Coil Power: 1.2 watts DC. 2 VA to 2.75 (60Hz) AC. @ 25°C
- Insulation System: Class "B" (130°C per UL standard 1446)
- Max. Coil Dissipation: 3.0 watts DC. @ 25°C.
- Duty: Continuous.

### CONTACTS

- Contact Material: Silver alloy, gold flashed standard., gold diffused contacts available
- Contact Rating: See "UL CONTACT LOAD RATINGS TABLE"
- Contact Resistance: 50 milliohms max. @ 10 amps, 120 VAC or 24 VDC contacts conditioned for 50 make and break operations @ 1 second "ON" & 1 second "OFF"

### DIELECTRIC STRENGTH

- Contacts to Coil: 1500 V rms
- Coil to Frame: 1500 V rms
- Across Open Contacts: 500 V rms
- Pole to Pole: 1500 V rms
- Contacts to Frame: 1500 V rms
- Insulation Resistance: 1000 megohms @ 500 VDC

### TEMPERATURE

- Operating: -45°C to +55°C (AC), -45°C to +70°C (DC).
- Storage: -40°C to +105°C

### VIBRATION RESISTANCE

- Functional: 10 to 55Hz; 1 mm (double amplitude)

### SHOCK RESISTANCE

- Functional: 10 g's
- Mechanical: 100 g's

### LIFE EXPECTANCY

- Electrical: 100,000 operations @ rated resistive load
- Mechanical: 5,000,000 operations @ no load

### MISCELLANEOUS

- Operating Position: Any
- Insulation Material: Molded plastic
- Enclosure: Polycarbonate dust cover
- Terminals: 8 or 11 pin octal plug-in
- Weight: 99.2 grams approx.

**MANUFACTURED UNDER  
ISO 9002 & QS 9000**



**Mating Sockets**  
70-750D8-1, 70-750D11-1,  
70-464-1, 70-465-1: SCREW/DIN  
70-169-1, 70-170-1: SCREW/PANEL  
See section 8, page 7 - 12



**DPDT & 3PDT  
3, 10 & 12 AMPS**

**OUTLINE DIMENSIONS**  
DIMENSIONS SHOWN IN INCHES & (MILLIMETERS).

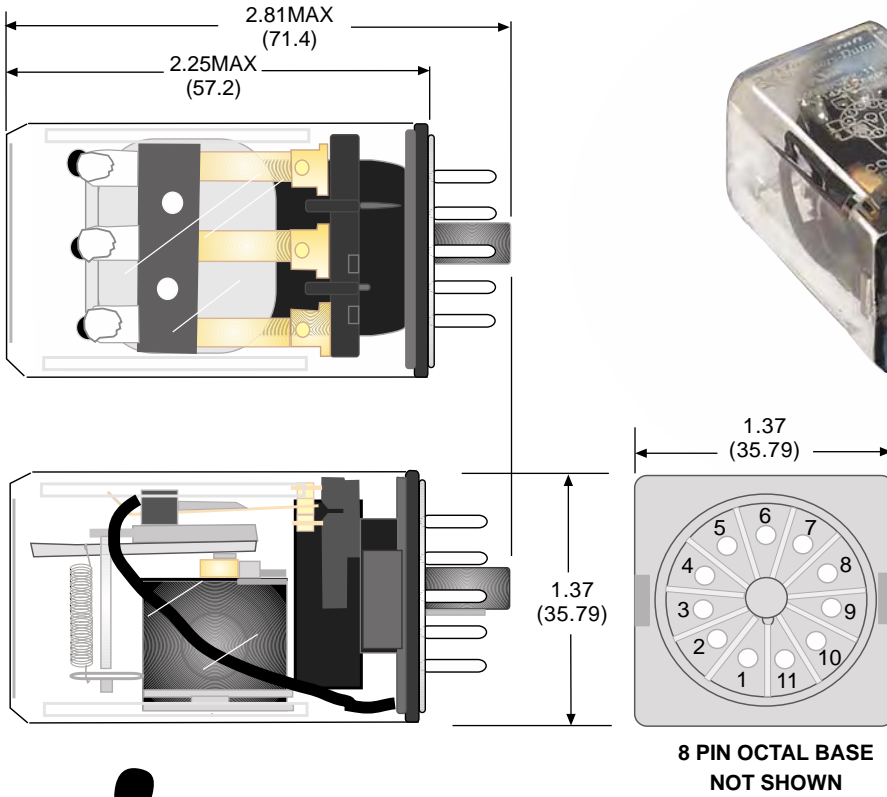

SEE CLASS 750 FOR PART NUMBERS WITH L.E.D. STATUS LAMP AND PUSH BUTTON

**WIRING DIAGRAMS**  
(VIEWED FROM PIN END)

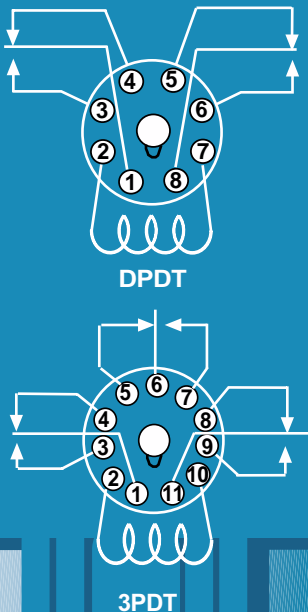

STANDARD PART NUMBERS	CONTACT CONFIGURATION	COIL MEASURED @ 25°C	
		NOMINAL INPUT VOLTAGE	NOMINAL RESISTANCE (OHMS)
<b>AC OPERATED, 12 AMP</b>			
A314XBX48P-24A	DPDT	24 VAC, 50/60Hz	85 Ω
A314XBX48P-120A	DPDT	120VAC, 50/60Hz	2250 Ω
A314XBX48P-240A	DPDT	220/240 VAC, 50/60Hz	9110 Ω
<b>AC OPERATED, 10 AMP</b>			
A314XCX48P-24A	3PDT	24 VAC, 50/60Hz	85 Ω
A314XCX48P-120A	3PDT	120 VAC, 50/60Hz	1700 Ω
A314XCX48P-240A	3PDT	220/240 VAC, 50/60Hz	9110 Ω
<b>DC OPERATED, 12 AMP</b>			
A314XBX48P-12D	DPDT	12VDC	120 Ω
A314XBX48P-24D	DPDT	24 VDC	472 Ω
<b>DC OPERATED, 10 AMP</b>			
A314XCX48P-12D	3PDT	12 VDC	120 Ω
A314XCX48P-24D	3PDT	24 VDC	472 Ω
<b>AC OPERATED WITH BLOW - OUT MAGNET, 3 AMP FOR DC SWITCHING</b>			
A314XBX48P69-24A	DPDT	24 VAC	85 Ω
A314XBX48P69-120A	DPDT	120VAC	1700 Ω
<b>DC OPERATED WITH BLOW - OUT MAGNET, 3 AMP FOR DC SWITCHING</b>			
A314XBX48P69-12D	DPDT	12 VDC	120 Ω
A314XBX48P69-24D	DPDT	24 VDC	472 Ω
A314XBX48P69-110D	DPDT	110 VDC	10,000 Ω

RETROFITS POTTER & BRUMFIELD KRPA.  
SEE END OF SECTION 1 FOR CROSS REFERENCE

## FEATURES

## BENEFITS

<b>FLAG INDICATOR:</b>	SHOWS RELAY STATUS IN MANUAL OR POWERED CONDITION.
<b>BI - POLAR L.E.D. STATUS LAMP:</b>	SHOWS COIL "ON" OR "OFF" STATUS. IDEAL IN LOW LIGHT CONDITIONS.
<b>PUSHBUTTON:</b>	ALLOWS FOR MANUAL OPERATION OF RELAY WITHOUT THE NEED FOR COIL POWER. IDEAL FOR FIELD SERVICE PERSONNEL TO TEST CONTROL CIRCUITS.
<b>LOCK-DOWN DOOR:</b>	WHEN ACTIVATED, HOLDS PUSH BUTTON AND CONTACTS IN THE OPERATE POSITION. EXCELLENT FOR ANALYZING CIRCUIT PROBLEMS.
<b>FINGER-GRIP COVER:</b>	ALLOWS OPERATOR TO REMOVE RELAYS FROM SOCKETS MORE EASILY THAN CONVENTIONAL RELAYS.
<b>I.D. TAG/WRITE LABEL:</b>	USED FOR IDENTIFICATION OF RELAYS IN MULTI - RELAY CIRCUITS.

DPDT &amp; 3PDT, 12 AMPS

**UL** us  
UL Recognized  
File No. E43641

**SP** LR40787

**CE**

**UL** LISTED 367G  
IND. CONT. EQ.  
C US

WHEN USED WITH  
SOCKET 70-463-1

CURRENT LIMITED TO  
RATING OF RELAY OR  
SOCKET WHICHEVER  
IS LESS

COMPLIES WITH REQUIREMENTS OF

\* IEC STANDARDS 947-4-1 AND  
947-5-1 LOW VOLTAGE DIRECTIVE

\* IEC = INTERNATIONAL  
ELECTROTECHNICAL COMMISSION

\* CE TESTING AND EVALUATION  
PERFORMED BY THE UNDERWRITERS  
LABORATORIES AS A THIRD PARTY  
PARTICIPANT

## GENERAL SPECIFICATIONS

MANUFACTURED UNDER  
ISO 9002 & QS 9000

## COIL

Pull-in Voltage:	80% of nominal voltage or less for DC coils, 85% of nominal voltage or less for AC coils
Dropout Voltage:	DC-10%, AC-30% of nominal voltage or more
Max. Voltage:	110%
Resistance:	±10% measured @ 25°C
Coil Power:	1.4 watts DC., 2 VA to 3.55 VA (60Hz) AC @ 25°C
Insulation System:	Class "B" (130°C per UL standard 1446)
Max. Coil Dissipation:	3.0 watts DC. 3.4 VA (60Hz) AC. @ 25°C
Duty:	Continuous

## CONTACTS

Contact Material:	Silver alloy, gold flashed
Contact Rating:	12 amps, 120/240 VAC 50/60Hz, 12 amps, 28 VDC 1/3Hp 120 VAC, 1/2Hp 240 VAC.
Contact Resistance:	50 milliohms max. @ 10 amps, 120 VAC or 24 VDC contacts conditioned for 50 make and break operations @ 1 second "ON" & 1 second "OFF"

## DIELECTRIC STRENGTH

Contacts to Coil:	2500 V rms
Across Open Contacts:	1500 V rms
Pole to Pole:	2500 V rms
Contacts to Frame:	2500 V rms
Insulation Resistance:	100 megohms @ 500 VDC

## TEMPERATURE

Operating:	-40°C to +50°C. (AC), -40°C +65°C. (DC)
Storage:	-40°C to +100°C

## LIFE EXPECTANCY

Electrical:	200,000 operations @ rated resistive load
Mechanical:	5,000,000 operations @ no load

## MISCELLANEOUS

Operating Position:	Any
Insulation Material:	Molded plastic
Enclosure:	Polycarbonate dust cover
Weight:	88 grams approx.



## Mating Sockets

70-463-1: SCREW/DIN

70-124-1: SOLDER

70-178-1, 70-178-2: PRINTED CIRCUIT

70-124-2: QUICK CONNECT

See section 8, page 16, 17

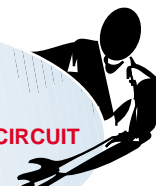

**DPDT & 3PDT, 12 AMPS**

**NEW**  
From The Market  
Leader in Industrial  
Relays

**OUTLINE DIMENSIONS**  
DIMENSIONS SHOWN IN INCHES & (MILLIMETERS).

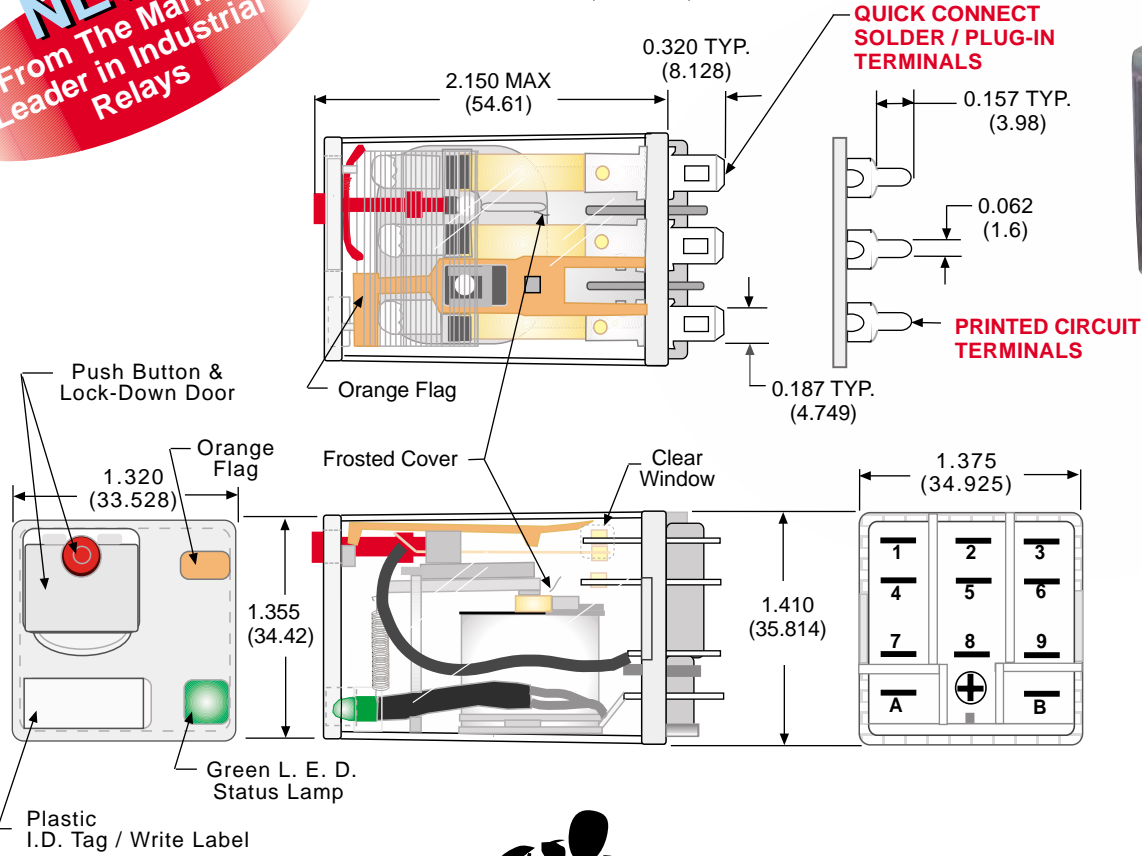

**BI - POLAR  
L.E.D. STATUS LAMP  
ALLOWS FOR REVERSE  
POLARITY APPLICATIONS**

**WIRING DIAGRAMS**  
(VIEWED FROM PIN END)

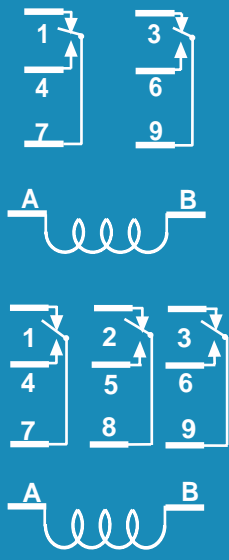

**ORDERING CODE FOR RELAYS**

**CLASS:** 788

**CONTACT CONFIGURATION:** **XBX**

**TERMINAL STYLE:** **M4L - 120A**

**STANDARD FEATURES:**  
PUSH BUTTON & LOCK DOWN DOOR: **CODE M4**  
BI - POLAR L.E.D. STATUS LAMP: **CODE L**

**OPTIONAL FEATURES:**  
PUSH BUTTON WITHOUT LOCK DOWN DOOR: **CODE M**

**COIL VOLTAGE:**  
6, 12, 24, 120, 220 / 230, 240 **ADD "A" FOR AC COILS**  
6, 12, 24, 48, 110 **ADD "D" FOR DC COILS**

STANDARD PART NUMBERS	CONTACT CONFIGURATION	COIL MEASURED @ 25°C	
		NOMINAL INPUT VOLTAGE	NOMINAL RESISTANCE (OHMS)
<b>AC OPERATED - SOLDER/PLUG-IN, 12 AMP</b>			
788XBXM4L-24A	DPDT	24 VAC, 50/60Hz	72 Ω
788XBXM4L-120A	DPDT	120 VAC, 50/60Hz	1,700 Ω
788XBXM4L-240A	DPDT	240 VAC, 50/60Hz	9,100 Ω
<b>DC OPERATED - SOLDER/PLUG-IN, 12 AMP</b>			
788XBXM4L-12D	DPDT	12 VDC	120 Ω
788XBXM4L-24D	DPDT	24 VDC	470 Ω
788XBXM4L-110D	DPDT	110 VDC	10,000 Ω
<b>AC OPERATED - SOLDER/PLUG-IN, 12 AMP</b>			
788XCXM4L-24A	3PDT	24 VAC, 50/60Hz	72 Ω
788XCXM4L-120A	3PDT	120 VAC, 50/60Hz	1,700 Ω
788XCXM4L-240A	3PDT	240 VAC, 50/60Hz	9,100 Ω
<b>DC OPERATED - SOLDER/PLUG-IN, 12 AMP</b>			
788XCXM4L-12D	3PDT	12 VDC	120 Ω
788XCXM4L-24D	3PDT	24 VDC	470 Ω
788XCXM4L-110D	3PDT	110 VDC	10,000 Ω

CADMIUM-FREE CONTACTS AVAILABLE,  
CONTACT FACTORY FOR DETAILS

**SPDT, DPDT & 3PDT, 15 AMPS**

## UL CONTACT LOAD RATINGS TABLE

POLES	CURRENT OR HORSE POWER	LOAD VOLTAGE	LOAD VOLTAGE FREQUENCY	TYPE OF LOAD
1 POLE THRU 3 POLES	15 AMP	120/240 VAC	50/60 Hz	RESISTIVE
	10 AMP	28 VDC	DC	RESISTIVE
	1/3 HP	120 VAC	50/60 Hz	MOTOR
	1/2 HP	240 VAC	50/60 Hz	MOTOR
	3 AMP	600 VAC	50/60 Hz	RESISTIVE

**UL** **us**  
UL Recognized  
File No. E13224

**SA** 168986

**UL** LISTED 367G  
IND. CONT. EQ.  
**C** **US**  
WHEN USED WITH  
SOCKETS 70-463-1

CURRENT LIMITED TO  
RATING OF RELAY OR  
SOCKET WHICHEVER  
IS LESS

**CE**  
COMPLIES WITH REQUIREMENTS OF  
\* IEC STANDARDS 947-4-1 AND  
947-5-1 LOW VOLTAGE DIRECTIVE  
\* IEC = INTERNATIONAL  
ELECTROTECHNICAL COMMISSION  
\* CE TESTING AND EVALUATION  
PERFORMED BY THE UNDERWRITERS  
LABORATORIES AS A THIRD PARTY  
PARTICIPANT

**MANUFACTURED UNDER  
ISO 9002 & QS 9000**

## GENERAL SPECIFICATIONS

### COIL

Pull-in Voltage: 80% of nominal voltage or less for DC coils  
85% of nominal voltage or less for AC coils

Dropout Voltage: 10% of nominal voltage or more

Max. Voltage: 110%

Resistance: ± 10 % measured at 25°C

Coil Power: 1.2 watts for DC coils,  
2 VA to 2.75 VA for AC @ 25°C

Insulation System: Class "B" (130°C per UL standard 1446)

Maximum Coil Dissipation: 3.0 watts max. DC

Duty: Continuous

### CONTACTS

Contact Material: 0.187 silver alloy, gold flashed

Contact Resistance: 50 milliohms maximum initial resistance  
at rated current

Contact Ratings: See "UL CONTACT LOAD RATINGS TABLE"

### DIELECTRIC STRENGTH

Contacts to Coil: 2000 V rms

Across Open Contacts: 500 V rms

Pole to Pole: 2000 V rms

Contacts to Frame: 2000 V rms

Insulation Resistance: 1000 megohms @ 500 VDC

### TEMPERATURE

Operating: -30°C to +50°C. (AC), -30°C to +65°C. (DC)

Storage: -30°C to +100°C

### LIFE EXPECTANCY

Electrical: 100,000 operations @ rated resistive load

Mechanical: 5,000,000 operations @ no load

### MISCELLANEOUS

Operating Position: Any

Insulation material: Molded plastic

Enclosure: Polycarbonate dust cover

Terminals: 0.187 x 0.032 quick connect flange or 0.187 x 0.020  
solder/plug-in. Optional printed circuit terminals available

Weight: 88 grams approx.



PLUG-IN



FLANGE MOUNT



OPTIONAL PRINTED CIRCUIT  
TERMINAL CONSULT FACTORY.

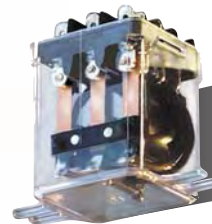

OPTIONAL TOP FLANGE  
COVER CONSULT FACTORY.



OPTIONAL DIN COVER  
CONSULT FACTORY.

**Mating Sockets**  
70-463-1: SCREW/DIN  
70-124-1: SOLDER  
70-178-1, 70-178-2: PRINTED CIRCUIT  
70-124-2: QUICK CONNECT  
See section 8, page 16, 17





**SPDT, DPDT & 3PDT, 15 AMPS**

**OUTLINE DIMENSIONS**  
DIMENSIONS SHOWN IN INCHES & (MILLIMETERS).

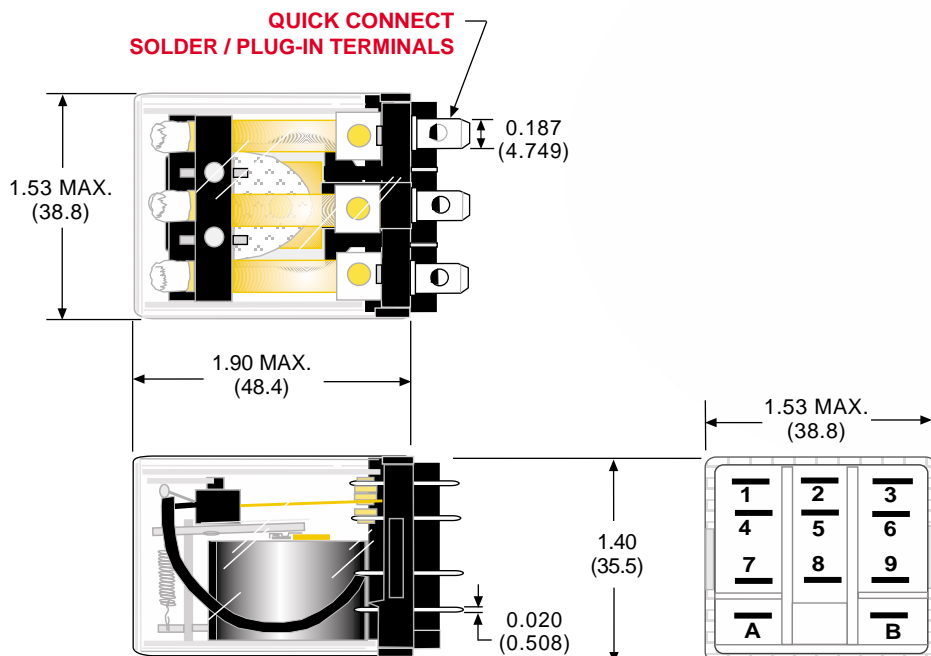

SEE CLASS 788 FOR  
PART NUMBERS WITH  
L.E.D. STATUS LAMP  
AND PUSH BUTTON

**WIRING DIAGRAMS**

(VIEWED FROM PIN END)

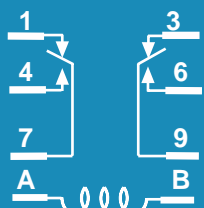

DPDT

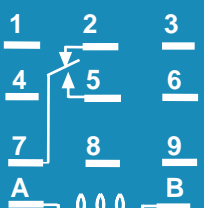

SPDT

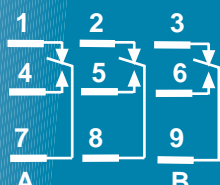

3PDT

STANDARD PART NUMBERS	CONTACT CONFIGURATION	COIL MEASURED @ 25°C	
		NOMINAL INPUT VOLTAGE	NOMINAL RESISTANCE (OHMS)
<b>AC OPERATED SOLDER/PLUG-IN, 15 AMP</b>			
A283XAXC-120A	SPDT	120 VAC, 50/60Hz	2250 Ω
A283XAXC-240A	SPDT	220/240 VAC, 50/60Hz	9100 Ω
A283XBXC-24A	DPDT	24 VAC, 50/60Hz	75 Ω
A283XBXC-120A	DPDT	120 VAC, 50/60Hz	2250 Ω
A283XBXC-240A	DPDT	220/240 VAC, 50/60Hz	9100 Ω
A283XCXC-24A	3PDT	24 VAC, 50/60Hz	72 Ω
A283XCXC-120A	3PDT	120 VAC, 50/60Hz	1700 Ω
A283XCXC-240A	3PDT	220/240 VAC, 50/60Hz	7200 Ω
<b>DC OPERATED SOLDER/PLUG-IN, 15 AMP</b>			
A283XAXC-12D	SPDT	12 VDC	120 Ω
A283XAXC-24D	SPDT	24 VDC	472 Ω
A283XBXC-12D	DPDT	12 VDC	120 Ω
A283XBXC-24D	DPDT	24 VDC	472 Ω
A283XBXC-110D	DPDT	110 VDC	10,000 Ω
A283XCXC-12D	3PDT	12 VDC	120 Ω
A283XCXC-24D	3PDT	24VDC	472 Ω

RETROFITS POTTER & BRUMFIELD KUP.  
SEE END OF SECTION 1 FOR CROSS REFERENCE

**SPDT, DPDT & 3PDT, 15 AMPS**

**OUTLINE DIMENSIONS**  
DIMENSIONS SHOWN IN INCHES & (MILLIMETERS).

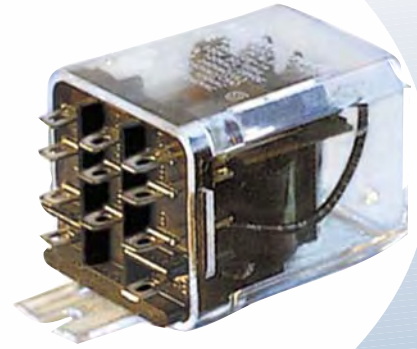
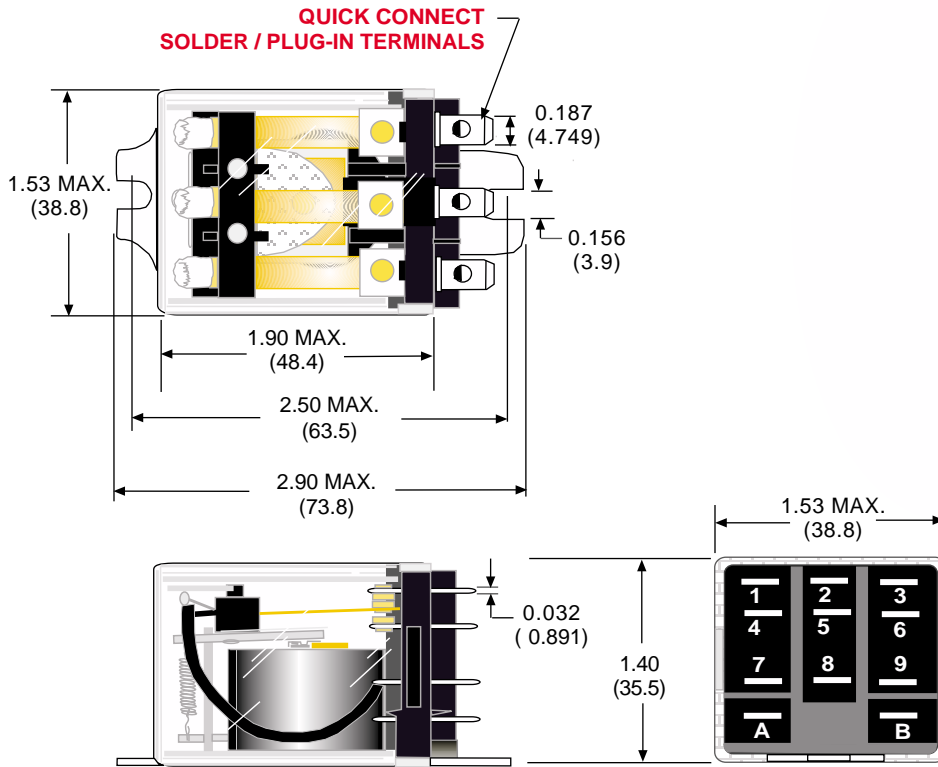

SEE CLASS 388J FOR PART NUMBERS WITH L.E.D. STATUS LAMP AND PUSH BUTTON

### WIRING DIAGRAMS

(VIEWED FROM PIN END)

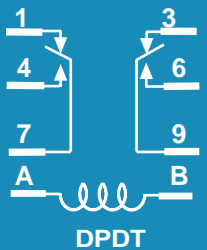

DPDT

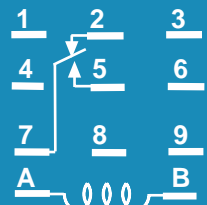

SPDT

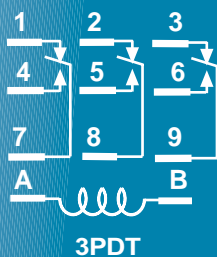

3PDT

STANDARD PART NUMBERS	CONTACT CONFIGURATION	COIL MEASURED @ 25°C	
		NOMINAL INPUT VOLTAGE	NOMINAL RESISTANCE (OHMS)
<b>AC OPERATED, 15 AMP</b>			
A283XAXC1-120A	SPDT	120 VAC, 50/60Hz	2250 Ω
A283XAXC1-240A	SPDT	220/240 VAC, 50/60Hz	9100 Ω
A283XBXC1-120A	DPDT	120 VAC, 50/60Hz	2250 Ω
A283XBXC1-240A	DPDT	220/240 VAC, 50/60Hz	9100 Ω
A283XCXC1-120A	3PDT	120 VAC, 50/60Hz	1700 Ω
A283XCXC1-240A	3PDT	220/240 VAC, 50/60Hz	7200 Ω
<b>DC OPERATED, 15 AMP</b>			
A283XAXC1-12D	SPDT	12 VDC	120 Ω
A283XAXC1-24D	SPDT	24 VDC	472 Ω
A283XBXC1-12D	DPDT	12 VDC	120 Ω
A283XBXC1-24D	DPDT	24 VDC	472 Ω
A283XCXC1-24D	3PDT	24 VDC	472 Ω

RETROFITS POTTER & BRUMFIELD KUP.  
SEE END OF SECTION 1 FOR CROSS REFERENCE

**DPDT , DPST-NO, SPST-NO-DM, SPDT-NO-DM -DB & SPST-NO-DM, 3 & 10 AMPS, 150 VDC SWITCHING**

**OUTLINE DIMENSIONS**  
DIMENSIONS SHOWN IN INCHES & (MILLIMETERS).

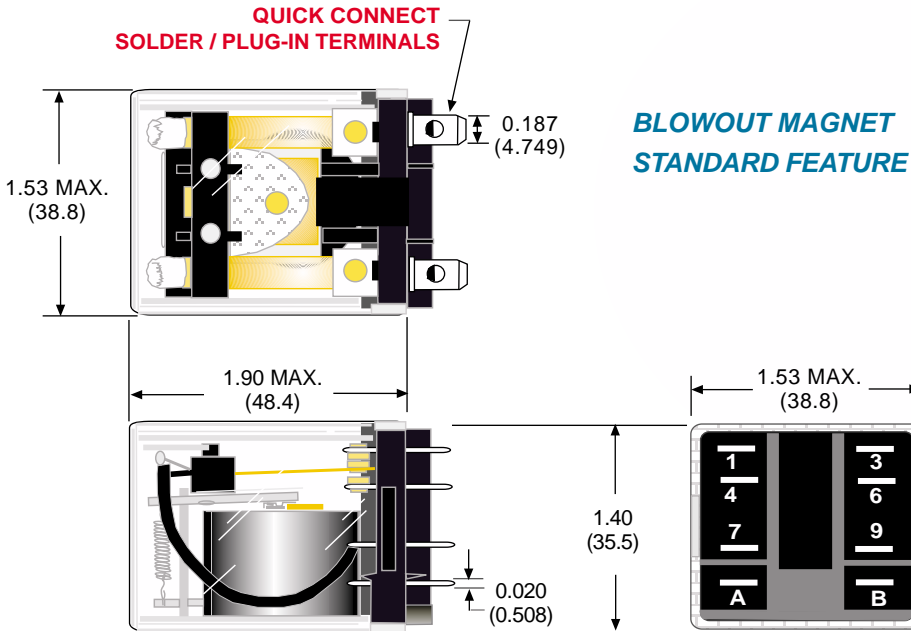

### UL CONTACT LOAD RATINGS TABLE FOR DC SWITCHING

POLES	CURRENT OR HORSE POWER	LOAD VOLTAGE	TYPE OF LOAD
DPDT	3 AMP	150 VDC	RESISTIVE
SPST (DM and/or DB)	10 AMP	150 VDC	RESISTIVE
SPST (N.O or N.C)	10 AMP	150 VDC	RESISTIVE

**THE BLOWOUT MAGNET STYLES HAVE THE SAME LOAD SPECIFICATIONS AS THE A283 ENCLOSED PLUG-IN RELAYS, PLUS THE ADDITIONAL LOAD RATINGS CHARTED IN TABLE ABOVE. SEE A283 GENERAL SPECIFICATIONS.**

### WIRING DIAGRAMS (VIEWED FROM PIN END)

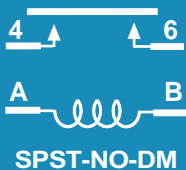
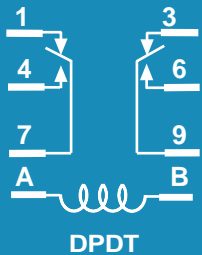

STANDARD PART NUMBERS	CONTACT CONFIGURATION	COIL MEASURED @ 25°C	
		NOMINAL INPUT VOLTAGE	NOMINAL RESISTANCE (OHMS)
<b>AC OPERATED WITH BLOWOUT MAGNET, 3 AMP</b>			
A283XBX69C-120A	DPDT	120 VAC, 50/60 Hz	2250 Ω
<b>DC OPERATED WITH BLOWOUT MAGNET, 3 AMP</b>			
A283XBX69C-12D	DPDT	12 VDC	120 Ω
A283XBX69C-24D	DPDT	24 VDC	472 Ω
A283XBX69C-110D	DPDT	110 VDC	10,000 Ω
<b>AC OPERATED WITH BLOWOUT MAGNET, 10 AMP</b>			
A283HXX69C-120A	SPST-NO (DM)	120 VAC, 50/60 Hz	2250 Ω
<b>DC OPERATED WITH BLOWOUT MAGNET, 10 AMP</b>			
A283HXX69C-48D	SPDT-NO (DM-DB)	48 VDC	1800 Ω
<b>DC OPERATED WITH BLOWOUT MAGNET, 5 AMP</b>			
A283BXX69C-24D	DPST-NO	24 VDC	472 Ω
A283BXX69C-48D	DPST-NO	48 VDC	1800 Ω
<b>DC OPERATED WITH BLOWOUT MAGNET, 10 AMP</b>			
A283HXX69C-12D	SPST-NO (DM)	12 VDC	120 Ω
A283HXX69C-24D	SPST-NO (DM)	24 VDC	472 Ω
A283HXX69C-48D	SPST-NO (DM)	48 VDC	1800 Ω
A283HXX69C-110D	SPST-NO (DM)	110 VDC	10,000 Ω

RETROFITS POTTER & BRUMFIELD KUEP.  
SEE END OF SECTION 1 FOR CROSS REFERENCE

**DPDT & 3PDT, 16 & 20 AMPS**

## UL CONTACT LOAD RATINGS TABLE

POLES	CURRENT OR HORSE POWER	LOAD VOLTAGE	LOAD VOLTAGE FREQUENCY	TYPE OF LOAD
2 POLES	20 AMP	300 VAC	50/60 Hz	RESISTIVE
	20 AMP	28 VDC	DC	RESISTIVE
3 POLES	16 AMP	277 VAC	50/60 Hz	RESISTIVE
	16 AMP	28 VDC	DC	RESISTIVE
2 & 3 POLES	3/4 HP	120 VAC	50/60 Hz	MOTOR
	1 HP	208-600 VAC	50/60 Hz	MOTOR

**UP TO 20 AMP SWITCHING**

**cRU** us  
UL Recognized  
File No. E43641



**UL** LISTED 367G  
IND. CONT. EQ.  
C US

WHEN USED WITH  
SOCKET 70-463-1

CURRENT LIMITED TO  
RATING OF RELAY OR  
SOCKET WHICHEVER  
IS LESS

COMPLIES WITH REQUIREMENTS OF

\* IEC STANDARDS 947-4-1 AND  
947-5-1 LOW VOLTAGE DIRECTIVE

\* IEC = INTERNATIONAL  
ELECTROTECHNICAL COMMISSION

\* CE TESTING AND EVALUATION  
PERFORMED BY THE UNDERWRITERS  
LABORATORIES AS A THIRD PARTY  
PARTICIPANT

## GENERAL SPECIFICATIONS

**MANUFACTURED UNDER  
ISO 9002 & QS 9000**

### COIL

Pull-in Voltage:	80% of nominal voltage or less for DC coils 85% of nominal voltage or less for AC coils
Dropout Voltage:	10% of nominal voltage or more
Resistance:	±10% measured at 25°C
Coil Power:	1.2 watts for DC coils, 2 VA to 2.75 VA for AC @ 25°C
Insulation System:	Class "B" (130°C per UL standard 1446)
Maximum Coil Dissipation:	3.0 watts max. DC
Duty:	Continuous

### CONTACTS

Contact material:	0.187 silver alloy, gold flashed
Contact Resistance:	50 milliohms maximum initial resistance at rated current
Contact Ratings:	See "UL CONTACT RATINGS TABLE"

### DIELECTRIC STRENGTH

Contacts to Coil:	2000 V rms
Across Open Contacts:	1500 V rms
Pole to Pole:	2000 V rms
Contacts to Frame:	2000 V rms
Insulation Resistance:	1000 megohms @ 500 VDC

### TEMPERATURE

Operating:	-30°C to +50°C. (AC), -30°C to +65°C. (DC)
Storage:	-30°C to +100°C

### LIFE EXPECTANCY

Electrical:	100,000 operations @ rated resistive load
Mechanical:	5,000,000 operations @ no load

### MISCELLANEOUS

Operating Position:	Any
Insulation material:	Molded plastic
Enclosure:	Polycarbonate dust cover
Terminals:	0.187 x 0.032 quick connect flange or 0.187 x 0.20 plug-in. Optional printed circuit terminals available
Weight:	94 grams approx.

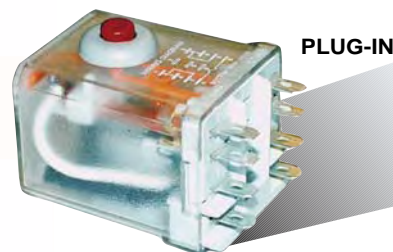

**PLUG-IN**

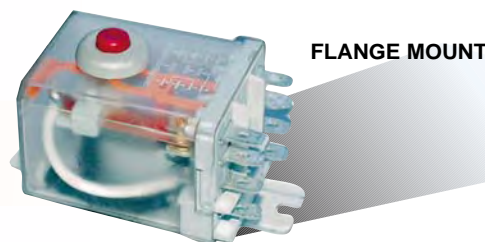

**FLANGE MOUNT**

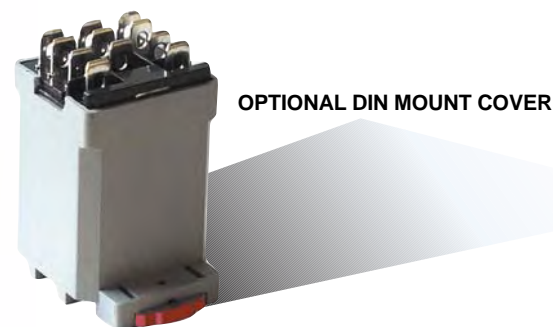

**OPTIONAL DIN MOUNT COVER**

**Mating Sockets**  
70-463-1: SCREW/DIN  
70-124-1: SOLDER  
70-178-1, 70-178-2: PRINTED CIRCUIT  
70-124-2: QUICK CONNECT  
See section 8, page 16, 17

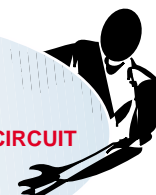

**DPDT & 3PDT, 16 & 20 AMPS**

**NEW**  
From The Market  
Leader in Industrial  
Relays

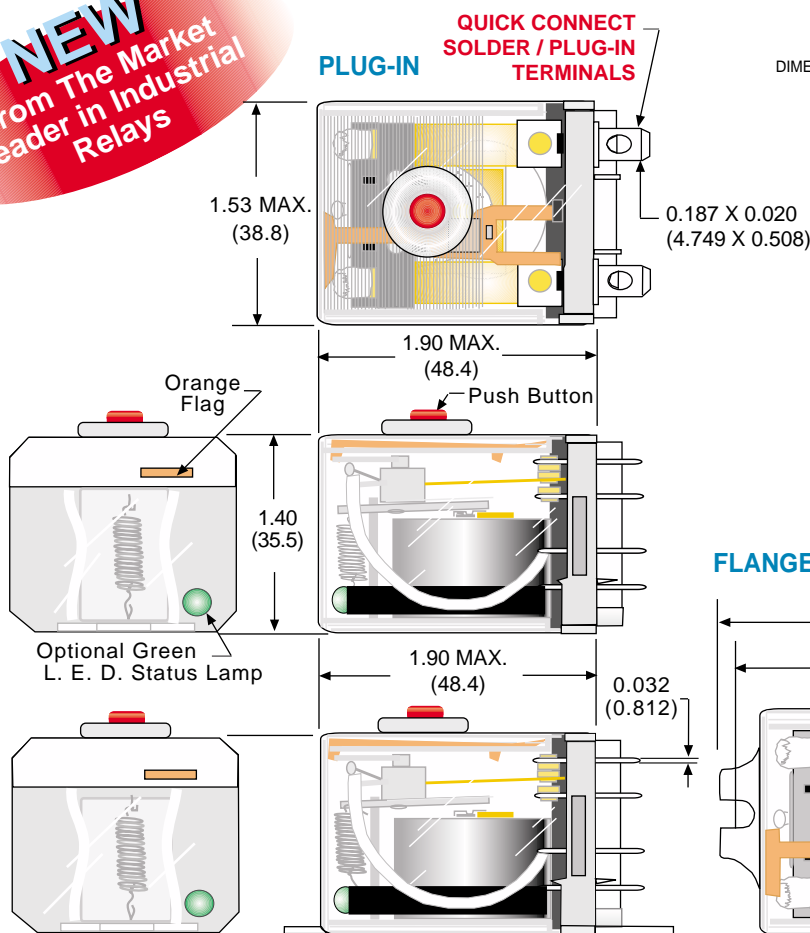

**OUTLINE DIMENSIONS**  
DIMENSIONS SHOWN IN INCHES & (MILLIMETERS).

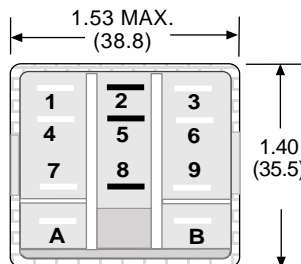

**FLAG INDICATOR & PUSH BUTTON STANDARD ON 388J RELAYS.**

**FLANGE COVER**

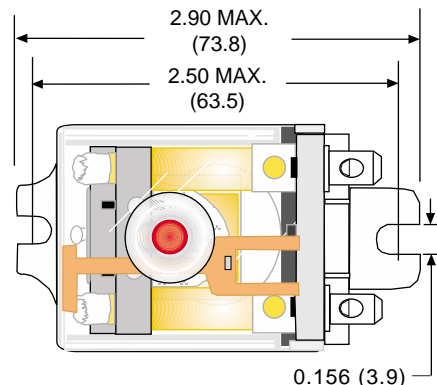

**WIRING DIAGRAMS**

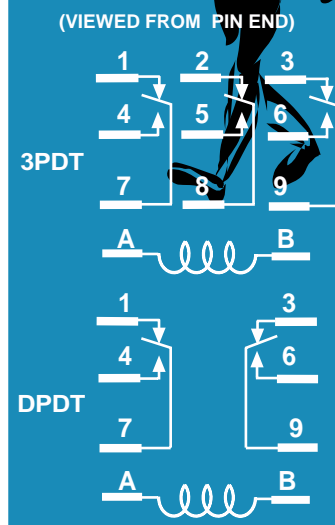

**ORDERING CODE FOR RELAYS**

**CLASS:** 388J XCX C1 M-240A  
FLAG INDICATOR STANDARD FEATURE

**CONTACT CONFIGURATION:** DPDT: XBX, 3PDT: XCX

**CONSTRUCTION STYLE:**  
\* ENCLOSED, PLAIN COVER: **CODE C**  
ENCLOSED, FLANGE COVER: **CODE C1**  
ENCLOSED, 6-32 TAPPED CORE & ANTI-ROTATION TAB: **CODE C2**  
ENCLOSED 6-32 STUD & ANTI-ROTATION TAB: **CODE CS2**  
ENCLOSED TOP FLANGE MOUNT: **CODE C3**  
ENCLOSED DIN MOUNT: **CODE C4**

**TERMINAL STYLE:**  
† QUICK CONNECT SOLDER TERMINALS: **NO CODE**  
PRINTED CIRCUIT TERMINALS: **CODE T**

**OPTIONS:**  
BI - POLAR L.E.D. STATUS LAMP: **CODE L**  
PUSH BUTTON: **CODE M**  
MAGNETIC BLOWOUT: **CODE 69**  
DC COIL SUPPRESSION: **CODE V**  
AC COIL SUPPRESSION: **CODE V1**  
RECTIFIED COIL: **CODE V2**

**COIL VOLTAGE:**  
6, 12, 24, 120, 240 **ADD "A" FOR AC COILS**  
6, 12, 24, 48, 110 **ADD "D" FOR DC COILS**

STANDARD PART NUMBERS	CONTACT CONFIGURATION	COIL MEASURED @ 25°C	
		NOMINAL INPUT VOLTAGE	NOMINAL RESISTANCE (OHMS)
<b>AC OPERATED FLANGE MOUNT WITH PUSH BUTTON, 16 AMP</b>			
388JXCXC1M-240A	3PDT	240 VAC,50/60Hz	7200 Ω
388JXCXC1M-120A	3PDT	120 VAC,50/60Hz	1700 Ω
<b>DC OPERATED FLANGE MOUNT WITH PUSH BUTTON, 16 AMP</b>			
388JXCXC1M-12D	3PDT	12 VDC	120 Ω
388JXCXC1M-24D	3PDT	24 VDC	470 Ω
<b>AC OPERATED PLUG-IN WITH PUSH BUTTON, 16 AMP</b>			
388JXCXCM-240A	3PDT	240 VAC,50/60Hz	7200 Ω
388JXCXCM-120A	3PDT	120 VAC,50/60Hz	1700 Ω
<b>DC OPERATED PLUG-IN WITH PUSH BUTTON, 16 AMP</b>			
388JXCXCM-12D	3PDT	12 VDC	120 Ω
388JXCXCM-24D	3PDT	24 VDC	470 Ω
<b>AC OPERATED FLANGE MOUNT WITH PUSH BUTTON, 20 AMP</b>			
388JXBXC1M-240A	DPDT	240 VAC,50/60Hz	9100 Ω
388JXBXC1M-120A	DPDT	120 VAC,50/60Hz	2250 Ω
<b>DC OPERATED FLANGE MOUNT WITH PUSH BUTTON, 20 AMP</b>			
388JXBXC1M-12D	DPDT	12 VDC	120 Ω
388JXBXC1M-24D	DPDT	24 VDC	470 Ω
<b>AC OPERATED PLUG-IN WITH PUSH BUTTON, 20 AMP</b>			
388JXBXCM-240A	DPDT	240 VAC,50/60Hz	9100 Ω
388JXBXCM-120A	DPDT	120 VAC,50/60Hz	2250 Ω
<b>DC OPERATED PLUG-IN WITH PUSH BUTTON, 20 AMP</b>			
388JXBXCM-12D	DPDT	12 VDC	120 Ω
388JXBXCM-24D	DPDT	24 VDC	470 Ω

RETROFITS SCHRACK RM. SEE END OF SECTION 1 FOR CROSS REFERENCE  
CADMIUM-FREE CONTACTS AVAILABLE, CONTACT FACTORY FOR DETAILS

\* Note: Code C recommended to be used with printed circuit terminals or Plug-in applications only.  
† 0.187 Quick connect or Solder terminals are socket Compatible.

**DPST-NO, 3PST-NO, 15 AMPS****UL CONTACT LOAD RATINGS TABLE**

POLES	CURRENT OR HORSE POWER	LOAD VOLTAGE	LOAD VOLTAGE FREQUENCY	TYPE OF LOAD
<b>1 POLE THRU 3 POLES</b>	15 AMP	120/240 VAC	50/60 Hz	RESISTIVE
	15 AMP	28 VDC	DC	RESISTIVE
	1/3 HP	120 VAC	50/60 Hz	MOTOR
	1/2 HP	240 VAC	50/60 Hz	MOTOR

**BENEFITS OF 3mm CONTACT GAP DESIGN:**

- HIGH DIELECTRIC STRENGTH ACROSS CONTACTS.**
- IMPROVED ARC QUENCHING WHEN BREAKING HIGH CURRENT LOADS.**
- MEETS EUROPEAN SPACING REQUIREMENTS OF 8mm ACROSS SURFACES**



UL Recognized  
File No. E43641



WHEN USED WITH  
SOCKET 70-463-1

CURRENT LIMITED TO  
RATING OF RELAY OR  
SOCKET WHICHEVER  
IS LESS

COMPLIES WITH REQUIREMENTS OF

\* IEC STANDARDS 947-4-1 AND  
947-5-1 LOW VOLTAGE DIRECTIVE

\* IEC = INTERNATIONAL  
ELECTROTECHNICAL COMMISSION

\* CE TESTING AND EVALUATION  
PERFORMED BY THE UNDERWRITERS  
LABORATORIES AS A THIRD PARTY  
PARTICIPANT

**MANUFACTURED UNDER  
ISO 9002 & QS 9000**

**GENERAL SPECIFICATIONS****COIL**

Pull-in Voltage:	80% of nominal voltage or less for DC coils 85% of nominal voltage or less for AC coils
Dropout Voltage:	10% of nominal voltage or more
Resistance:	±10% measured at 25°C
Coil Power:	1.2 watts for DC coils, 2 VA to 2.75 VA for AC @ 25°C
Insulation System:	Class "B" (130°C per UL standard 1446)
Maximum Coil Dissipation:	3.0 watts max. DC
Duty:	Continuous

**CONTACTS**

Contact material:	Silver alloy, gold flashed
Contact Resistance:	50 milliohms maximum initial resistance at rated current
Contact Ratings:	See "UL CONTACT LOAD RATINGS TABLE"

**DIELECTRIC STRENGTH**

Contacts to Coil:	3 mm gap, 4000 V rms
Across Open Contacts:	3 mm gap, 1000 V rms
Pole to Pole:	2000 V rms
Contacts to Frame:	2000 V rms
Insulation Resistance:	1000 megohms @ 500 VDC

**TEMPERATURE**

Operating:	-30°C to +50°C. (AC), -30°C to +65°C. (DC)
Storage:	-30°C to +100°C

**LIFE EXPECTANCY**

Electrical:	100,000 operations @ rated resistive load
Mechanical:	5,000,000 operations @ no load

**MISCELLANEOUS**

Operating Position:	Any
Insulation material:	Molded plastic
Enclosure:	Polycarbonate dust cover
Terminals:	0.187 x 0.032 quick connect flange or 0.187 x 0.020 solder/plug-in. Optional printed circuit terminals available
Weight:	88 grams approx.

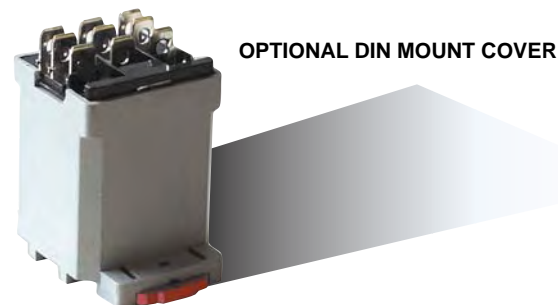
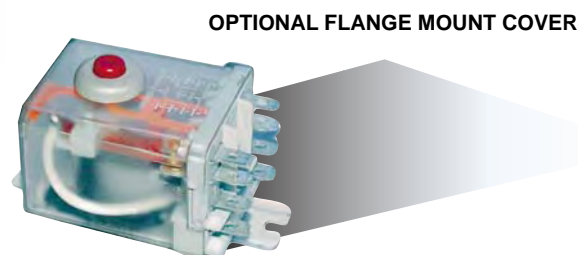
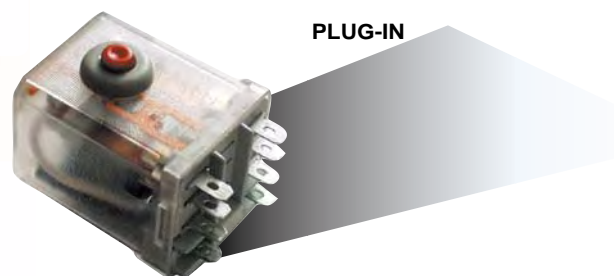

**Mating Sockets**  
**70-463-1: SCREW/DIN**  
**70-124-1: SOLDER**  
**70-178-1, 70-178-2: PRINTED CIRCUIT**  
**70-124-2: QUICK CONNECT**  
 See section 8, page 16, 17

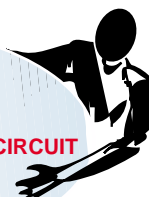

**DPST-NO, 3PST-NO, 15 AMPS**

**OUTLINE DIMENSIONS**

DIMENSIONS SHOWN IN INCHES & (MILLIMETERS).

**PLUG-IN**

**FLANGE COVER**

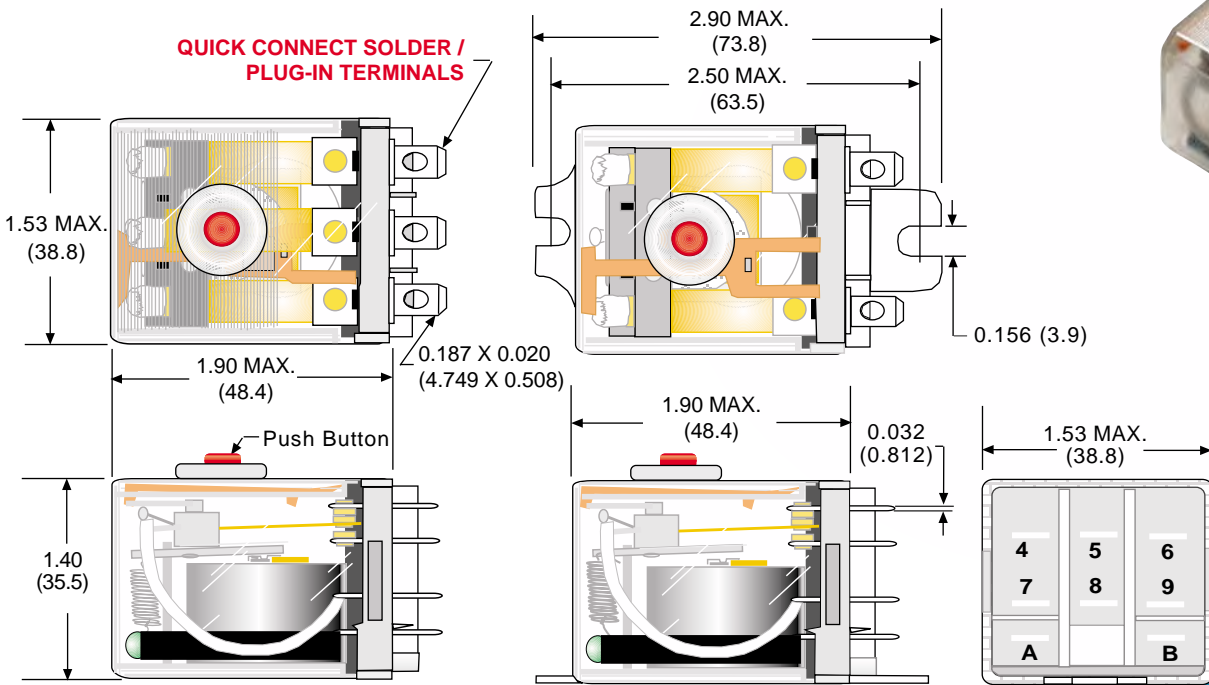

**WIRING DIAGRAMS**

(VIEWED FROM PIN END)

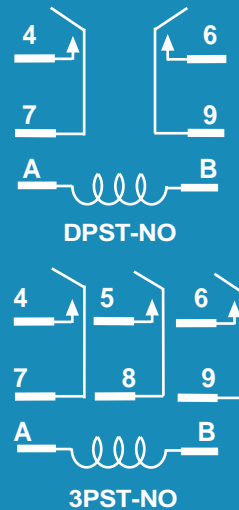

**3 MILLIMETER CONTACT GAP. PUSH BUTTON STANDARD.**

**ORDERING CODE FOR RELAYS**

**388V CXX C1 M 24A**

**CLASS:** \_\_\_\_\_

**CONTACT CONFIGURATION:** \_\_\_\_\_

**BXX** - (DPST-NO) 3 MM CONTACT GAP,  
**CXX** - (3PST-NO) 3 MM CONTACT GAP,

**CONSTRUCTION STYLE:** \_\_\_\_\_

- \* ENCLOSED, PLAIN COVER: **CODE C**
- ENCLOSED, FLANGE COVER: **CODE C1**
- ENCLOSED, 6-32 TAPPED CORE & ANTI-ROTATION TAB: **CODE C2**
- ENCLOSED 6-32 STUD & ANTI-ROTATION TAB: **CODE CS2**
- ENCLOSED TOP FLANGE MOUNT: **CODE C3**
- ENCLOSED DIN MOUNT: **CODE C4**

**TERMINAL STYLE:** \_\_\_\_\_

- † QUICK CONNECT SOLDER/PLUG-IN TERMINALS: **NO CODE**
- PRINTED CIRCUIT TERMINALS: **CODE T**

**OPTIONS:** \_\_\_\_\_

- BI - POLAR L.E.D. STATUS LAMP: **CODE L**
- PUSH BUTTON: **CODE M**
- MAGNETIC BLOWOUT: **CODE 69**
- DC COIL SUPPRESSION: **CODE V**
- AC COIL SUPPRESSION: **CODE V1**
- RECTIFIED COIL: **CODE V2**

**COIL VOLTAGE:** \_\_\_\_\_

- 6, 12, 24, 120, 240 ADD "A" FOR AC COILS
- 6, 12, 24, 48, 110 ADD "D" FOR DC COILS

\* Note: Code C recommended to be used with printed circuit terminals or Plug-in applications only.  
† 0.187 Quick connect or solder terminals are socket compatible.

STANDARD PART NUMBERS	CONTACT CONFIGURATION	COIL MEASURED @ 25°C	
		NOMINAL INPUT VOLTAGE	NOMINAL RESISTANCE (OHMS)
<b>AC OPERATED PLUG-IN WITH PUSH BUTTON 3mm GAP, 15 AMP</b>			
388VCXXCM-220/240A	3PST-NO	220/240 VAC,50/60Hz	9100 Ω
388VCXXCM-120A	3PST-NO	120 VAC,50/60Hz	1100 Ω
388VCXXCM-24A	3PST-NO	24 VAC,50/60Hz	75 Ω
388VBXXCM-220/240A	DPST-NO	220/240 VAC,50/60Hz	9100 Ω
388VBXXCM-120A	DPST-NO	120 VAC,50/60Hz	1100 Ω
388VBXXCM-24A	DPST-NO	24 VAC,50/60 Hz	75 Ω
<b>DC OPERATED PLUG-IN WITH PUSH BUTTON 3mm GAP, 15 AMP</b>			
388VCXXCM-24D	3PST-NO	24 VDC	240 Ω
388VCXXCM-12D	3PST-NO	12 VDC	120 Ω
388VBXXCM-24D	DPST-NO	24 VDC	240 Ω
388VBXXCM-12D	DPST-NO	12 VDC	120 Ω

**20, 25 & 30 AMPS**

## DIELECTRIC STRENGTH CHART (V rms)

	SPDT	DPDT	3PDT	SPDT-DM,DB,DM-DB
COIL TO FRAME	1600	1600	1600	1600
ACROSS OPEN CONTACTS	1000	1000	1000	1500
CONTACT TO FRAME	1600	1600	1600	1600
COIL TO CONTACTS	2200	2200	1600	2200
POLE TO POLE	-	2200	1600	-
CONTACTS TO METAL MOUNTING PLATE (COVER INSTALLED)	2200	2200	1600	2200
COIL TO METAL MOUNTING PLATE (COVER INSTALLED)	2200	2200	2200	2200

**UL** us  
UL Recognized  
File No. E 43641

**SP** 168986

**CE**

COMPLIES WITH REQUIREMENTS OF

\* IEC STANDARDS 947-4-1 AND 947-5-1 LOW VOLTAGE DIRECTIVE

\* IEC = INTERNATIONAL ELECTROTECHNICAL COMMISSION

\* CE TESTING AND EVALUATION PERFORMED BY THE UNDERWRITERS LABORATORIES AS A THIRD PARTY PARTICIPANT

**MANUFACTURED UNDER  
ISO 9002 & QS 9000**

## GENERAL SPECIFICATIONS

**COIL**

Pull-in Voltage: 80% of nominal voltage or less for DC coils  
85% of nominal voltage or less for AC coils

Dropout Voltage: 10% of nominal voltage or more

Resistance: ±10% measured @ 25°C

Coil Power: 1.44 watts for DC coils, 2 VA to 3.5 VA for AC coils

Insulation System: Class "B" Coil system. (130°C per UL standard 1446)

Max. Coil Dissipation: 2.5 watts max. DC

Duty: Continuous

**CONTACTS**

Contact Material: 0.250 silver alloy, gold flashed

Contact Rating: See next page

Contact Resistance: 50 milliohms maximum initial resistance at rated current

**TIMING**

Operate Time: 20 mS max. @ nominal voltage

Release Time: 20 mS max. @ nominal voltage

**DIELECTRIC STRENGTH**

Dielectric Strength: See "DIELECTRIC STRENGTH CHART"

Insulation Resistance: 1,000 megohms min. @ 500 VDC

**TEMPERATURE**

Operating: -30°C to +50°C. (AC), -30°C to +65°C. (DC)

Storage: -30°C to +100°C

**LIFE EXPECTANCY**

Electrical: 100,000 operations @ rated resistive load

Mechanical: 5,000,000 operations @ no load

**MISCELLANEOUS**

Operating Position: Any

Insulation Material: Molded plastic

Enclosure: Polycarbonate dust cover

Terminals: 0.250 x 0.032 quick connect/solder terminals  
Optional printed circuit terminals. (0.090 x 0.032) available

Weight: 94 grams approx with cover

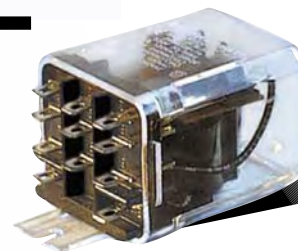

**STANDARD SIDE  
FLANGE COVER**



**OPTIONAL PRINTED  
CIRCUIT TERMINAL  
CONSULT FACTORY.**

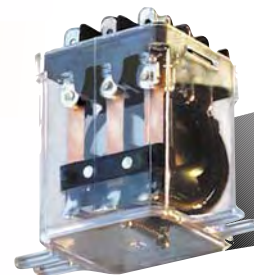

**OPTIONAL TOP FLANGE COVER  
CONSULT FACTORY.**



**OPTIONAL DIN COVER  
CONSULT FACTORY.**





## CLASS 389 LOAD RATINGS

POLES	ENCLOSED STYLE 1, 2 AND 3 POLE			
	CURRENT OR HORSEPOWER	LOAD VOLTAGE	LOAD VOLTAGE FREQUENCY	TYPE OF LOAD
1 POLES	13A	28	DC	RESISTIVE
	20A	15	DC	RESISTIVE
	25A	300	50/60 Hz	RESISTIVE
	5A	600	50/60 Hz	RESISTIVE
	20A	277	50/60 Hz	BALLAST
	1HP	120	50/60 Hz	MOTOR
	1-1/2HP	208/240	50/60 Hz	MOTOR
	1HP	480/600	50/60 Hz	MOTOR
	660VA	120	50/60 Hz	PILOT DUTY
	915VA	208	50/60 Hz	PILOT DUTY
	960VA	240	50/60 Hz	PILOT DUTY
	765VA	480/600	50/60Hz	PILOT DUTY
	•B600		50/60Hz	PILOT DUTY
	2 POLES	13A	28	DC
20A		15	DC	RESISTIVE
25A		300	50/60 Hz	RESISTIVE
5A		600	50/60 Hz	RESISTIVE
20A		277	50/60 Hz	BALLAST
1HP		120	50/60 Hz	MOTOR
1-1/2HP		208/240	50/60 Hz	MOTOR
1HP		480/600	50/60 Hz	MOTOR
660VA		120	50/60 Hz	PILOT DUTY
915VA		208	50/60 Hz	PILOT DUTY
960VA		240	50/60 Hz	PILOT DUTY
765VA		460/600	50/60Hz	PILOT DUTY
B600			50/60Hz	PILOT DUTY
3 POLES		13A	28	DC
	15A	28	DC (NO)	RESISTIVE
	20A	15	DC	RESISTIVE
	20A	150	50/60 Hz	RESISTIVE
	††15A	250	50/60 Hz	RESISTIVE
	†10A	300	50/60 Hz	RESISTIVE
	20A	150	50/60 Hz	BALLAST
	6-2/3HP	277	50/60 Hz	BALLAST
	1/2HP	120	50/60Hz	MOTOR
	1/2HP	208/240	50/60 Hz	MOTOR
	1HP	240	50/60 Hz	MOTOR
	3/4HP	120	50/60Hz	MOTOR
	470VA	120/240	50/60Hz	PILOT DUTY
	445VA	208	50/60Hz	PILOT DUTY
	B300		50/60Hz	PILOT DUTY

## CLASS 389D LOAD RATINGS

POLE	ENCLOSED STYLE 1, 2 AND 3 POLE			
	CURRENT OR HORSE POWER	LOAD VOLTAGE	LOAD VOLTAGE FREQUENCY	TYPE OF LOAD
1 POLE	30A	28	DC	RESISTIVE
	30A	300	50/60 Hz	RESISTIVE
	10A	600	50/60 Hz	RESISTIVE
	1HP	120	50/60 Hz	MOTOR
	1-1/2HP	200 thru 600	50/60 Hz	MOTOR
	765VA	120	50/60 Hz	PILOT DUTY
	915VA	208	50/60 Hz	PILOT DUTY
	960VA	240,480,600	50/60 Hz	PILOT DUTY
	A600		50/60 Hz	PILOT DUTY

## CLASS 389 BALLAST LOAD RATINGS

POLES	ENCLOSED STYLE		
SPDT	20 AMP	277 VAC	50/60Hz
DPDT	20 AMP	277 VAC	50/60Hz
3PDT	20 AMP	150 VAC	50/60Hz
	6 2/3 AMP	277 VAC	50/60Hz
<b>DOUBLE BREAK DOUBLE MAKE (1 FORM "X" &amp; "Z")</b>			
SPDT	25 AMP	277 VAC	50/60Hz

†† UL APPLIANCE RATED. ALL OTHER RATINGS NOT SO MARKED ARE INDUSTRIAL RATED  
 † CSA RATING ONLY, NOT UL



## 1, 2 & 3 POLE NEMA PILOT DUTY CONTACT RATINGS

NEMA CONTACT CODE DESIGNATION	THERMAL CONTINUOUS TEST CURRENT AMPERES	MAXIMUM CURRENT, AMPERES									
		120 VOLTS 50/60Hz		240 VOLTS 50/60Hz		480 VOLTS 50/60Hz		600 VOLTS 50/60Hz		MAXIMUM VOLT-AMPERES	
		MAKE	BREAK	MAKE	BREAK	MAKE	BREAK	MAKE	BREAK	MAKE	BREAK
A600	10	60	6.00	30	3.00	15	1.50	12	1.20	7200	720
B300	5	30	3.00	15	1.50					3600	360
B600	5	30	3.00	15	1.50	0.75	0.75	0.6	0.6	3600	360

**DPDT, 3PDT, 20 & 25 AMPS**

**NEW**  
From The Market  
Leader in Industrial  
Relays

**OUTLINE DIMENSIONS**

DIMENSIONS SHOWN IN INCHES & (MILLIMETERS).

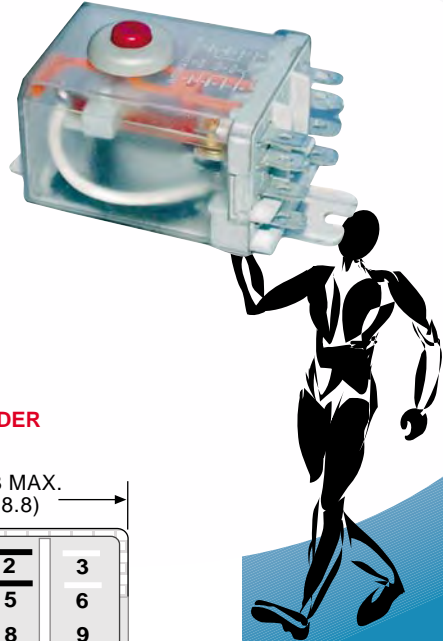
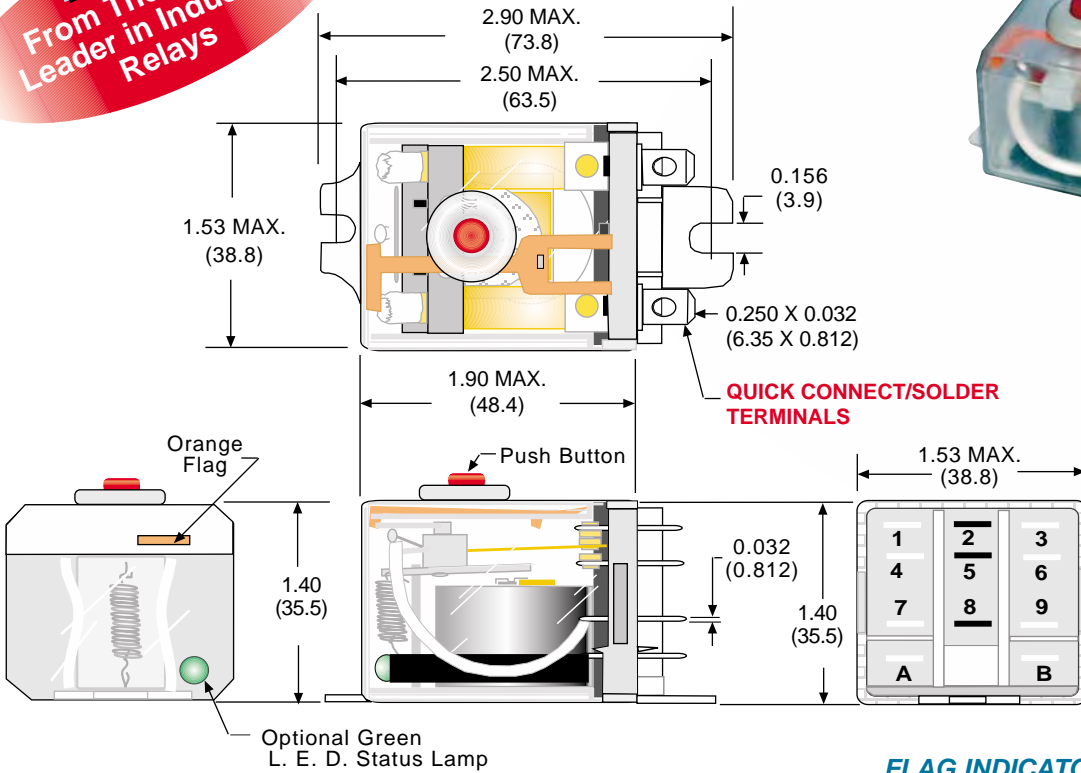

**WIRING DIAGRAMS**  
(VIEWED FROM PIN END)

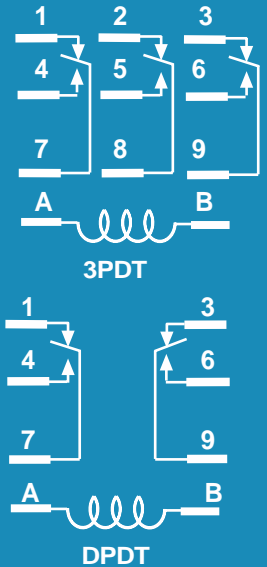

**FLAG INDICATOR & PUSH BUTTON STANDARD ON 389F RELAYS.**

**ORDERING CODE FOR RELAYS**

**389F XCX C1 M - 120A**

- CLASS:** \_\_\_\_\_  
FLAG INDICATOR STANDARD FEATURE
- CONTACT CONFIGURATION:** \_\_\_\_\_  
DPDT: **XBX**, 3PDT: **XCX**
- CONSTRUCTION STYLE:** \_\_\_\_\_  
\* ENCLOSED, PLAIN COVER: **CODE C**  
ENCLOSED, FLANGE COVER: **CODE C1**  
ENCLOSED, 6-32 TAPPED CORE & ANTI-ROTATION TAB: **CODE C2**  
ENCLOSED 6-32 STUD & ANTI-ROTATION TAB: **CODE CS2**  
ENCLOSED TOP FLANGE MOUNT: **CODE C3**  
ENCLOSED DIN MOUNT: **CODE C4**
- TERMINAL STYLE:** \_\_\_\_\_  
0.250 QUICK CONNECT SOLDER TERMINALS: **NO CODE**  
PRINTED CIRCUIT TERMINALS: **CODE T**
- OPTIONS:** \_\_\_\_\_  
BI - POLAR L.E.D. STATUS LAMP: **CODE L**  
PUSH BUTTON: **CODE M**  
MAGNETIC BLOWOUT: **CODE 69**  
DC COIL SUPPRESSION: **CODE V**  
AC COIL SUPPRESSION: **CODE V1**  
RECTIFIED COIL: **CODE V2**
- COIL VOLTAGE:** \_\_\_\_\_  
6, 12, 24, 120, 240 ADD "A" FOR AC COILS  
6, 12, 24, 48, 110 / 125, 220 / 250 ADD "D" FOR DC COILS

\* Note: Code C recommended to be used with printed circuit terminals only.

STANDARD PART NUMBERS	CONTACT CONFIGURATION	COIL MEASURED @ 25°C	
		NOMINAL INPUT VOLTAGE	NOMINAL RESISTANCE (OHMS)
<b>AC OPERATED FLANGE MOUNT WITH PUSH BUTTON, 20 AMP</b>			
389FXCXC1M-240A	3PDT	240 VAC, 50/60Hz	4600 Ω
389FXCXC1M-120A	3PDT	120 VAC, 50/60Hz	1200 Ω
<b>AC OPERATED FLANGE MOUNT WITH PUSH BUTTON, 25 AMP</b>			
389FBXC1M-240A	DPDT	240 VAC, 50/60Hz	7200 Ω
389FBXC1M-120A	DPDT	120 VAC, 50/60Hz	1700 Ω
<b>DC OPERATED FLANGE MOUNT WITH PUSH BUTTON, 20 AMP</b>			
389FXCXC1M-12D	3PDT	12 VDC	100 Ω
389FXCXC1M-24D	3PDT	24 VDC	400 Ω
<b>DC OPERATED FLANGE MOUNT WITH PUSH BUTTON, 25 AMP</b>			
389FBXC1M-12D	DPDT	12 VDC	100 Ω
389FBXC1M-24D	DPDT	24 VDC	400 Ω

RETROFITS SCHRACK RM.  
SEE END OF SECTION 1 FOR CROSS REFERENCE

**20, 25 & 30 AMPS**

**OUTLINE DIMENSIONS**

DIMENSIONS SHOWN IN INCHES & (MILLIMETERS).

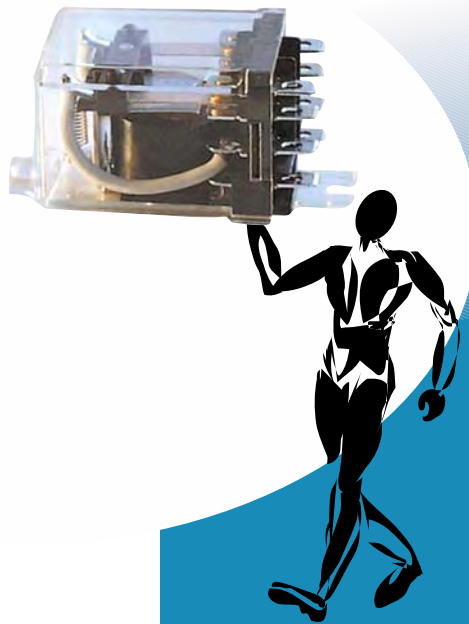
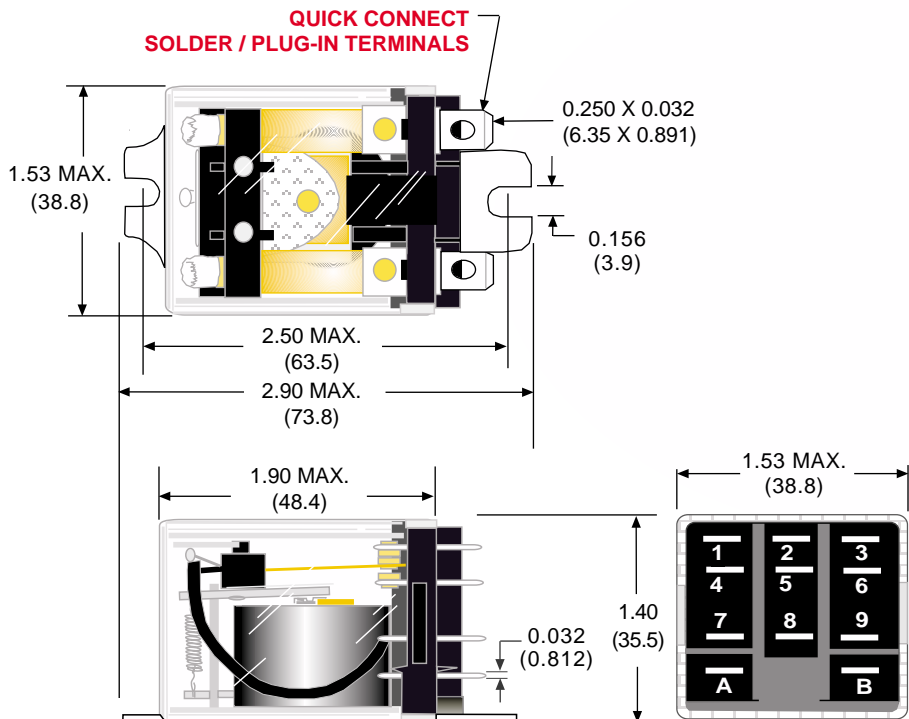

**WIRING DIAGRAMS**

(VIEWED FROM PIN END)

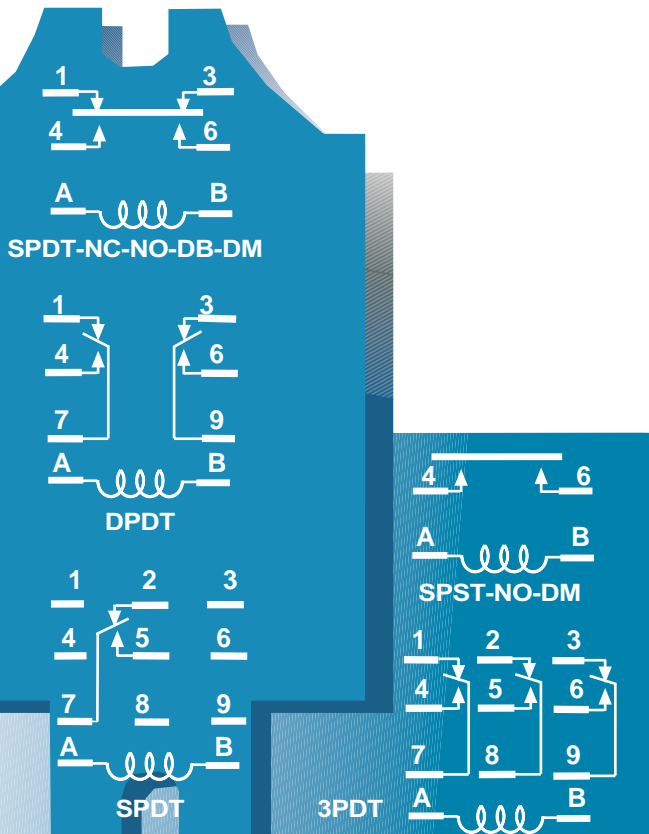

STANDARD PART NUMBERS	CONTACT CONFIGURATION	COIL MEASURED @ 25°C	
		NOMINAL INPUT VOLTAGE	NOMINAL RESISTANCE (OHMS)
<b>AC OPERATED FLANGE MOUNT, 30 AMP</b>			
W389ADCX-4	SPST-NO (DM)	120 VAC,50/60Hz	1100 Ω
W389ADCX-5	SPST-NO (DM)	220/240 VAC,50/60Hz	4300 Ω
W389ADZCX-3	SPDT-NO-NC (DM-DB)	24 VAC,50/60Hz	44 Ω
W389ADZCX-4	SPDT-NO-NC (DM-DB)	120 VAC,50/60Hz	1100 Ω
<b>DC OPERATED FLANGE MOUNT, 30 AMP</b>			
W389DCX-2	SPST-NO (DM)	12 VDC	100 Ω
W389DCX-3	SPST-NO (DM)	24 VDC	400 Ω
W389DZCX-2	SPST-NO-NC (DM-DB)	12 VDC	100 Ω
W389DZCX-3	SPST-NO-NC (DM-DB)	24VDC	400 Ω
<b>AC OPERATED FLANGE MOUNT, 25 AMP</b>			
W389ACX-4	SPDT	120 VAC,50/60Hz	1700 Ω
W389ACX-8	DPDT	24 VAC,50/60Hz	72 Ω
W389ACX-9	DPDT	120 VAC,50/60Hz	1700 Ω
W389ACX-10	DPDT	220/240 VAC,50/60Hz	7200 Ω
<b>AC OPERATED FLANGE MOUNT, 20 AMP</b>			
W389ACX-14	3PDT	120 VAC,50/60Hz	1200 Ω
W389ACX-15	3PDT	220/240 VAC,50/60Hz	4600 Ω
<b>DC OPERATED FLANGE MOUNT, 25 AMP</b>			
W389CX-2	SPDT	12 VDC	100 Ω
W389CX-3	SPDT	24VDC	400 Ω
W389CX-7	DPDT	12 VDC	100 Ω
W389CX-8	DPDT	24VDC	400 Ω
<b>DC OPERATED FLANGE MOUNT, 20 AMP</b>			
W389CX-12	3PDT	12 VDC	100 Ω
W389CX-13	3PDT	24VDC	400 Ω

RETROFITS POTTER & BRUMFIELD KUMP & KUHF  
SEE END OF SECTION 1 FOR CROSS REFERENCE

## FEATURES

## BENEFITS

OPTIONAL BLOWOUT MAGNET	HIGH VOLTAGE DC SWITCHING
WIDE SPACING BETWEEN STATIONARY CONTACT TERMINALS	CLEARANCE FOR FULLY BOOTED QUICK CONNECT TERMINALS
ARC BARRIERS BETWEEN CONTACTS	IMPROVED DIELECTRIC STRENGTH BETWEEN CONTACT SETS.
2 MILLIMETER CONTACT GAPS	8 MILLIMETER CREEPAGE AND CLEARANCE TO MEET INTERNATIONAL REQUIREMENTS.
IMPROVED DIELECTRIC STRENGTH BETWEEN CONTACT	4000 Vrms DIELECTRIC BETWEEN MUTUALLY INSULATED CONDUCTIVE ELEMENTS AND FRAME.
WIDE SELECTION OF MOUNTING OPTIONS	ALLOWS INSTALLATIONS TO BE "CUSTOMIZED"

**DPDT, UP TO 30 AMPS  
UP TO 600 VAC OR 150 VDC**

**cULus**  
UL Recognized  
File No. E13224

**SA** 50758

**MANUFACTURED UNDER  
ISO 9002 & QS 9000**

## GENERAL SPECIFICATIONS

### COIL

Pull-in Voltage:	85% of nominal voltage or less for AC coils, 80% of nominal voltage or less for DC coils
Dropout Voltage:	10% min. of nominal voltage or more
Max. Voltage:	110%
Resistance:	±10% measured @ 25°C
Coil Power:	2.0 watts DC, 3.0 VA (60Hz) AC. @ 25°C
Insulation System:	Class "B" (130°C per UL standard 1446), Class "F" (155°C available)
Max. Coil Dissipation:	3.0 watts DC., 3.4 VA (60Hz) AC
Duty:	Continuous

### CONTACTS

Contact Material:	Silver alloy, gold flashed
Contact Rating:	30 amps @ 120/240/277 VAC. 20 amps @ 480 VAC (general purpose) 15 amps @ 600 VAC (resistive load). 30 amps @ 28 VDC (resistive load). 1Hp @ 120 VAC 50/60 Hz. 2 Hp @ 208, 240, 480, 600 VAC. 50/60 Hz (motor load). <b>Code 69</b> - DPDT: 5 amps @ 150 VDC; SPDT-DM-DB: 10 amps @ 150 VDC; 20 amps @ 72 VDC; DPTS-NO: 3 amps @ 220 VDC

### TIMING

Operate Time:	20 mS max. @ nominal voltage
Release Time:	15 mS max. @ nominal voltage

### DIELECTRIC STRENGTH

Contacts to Coil:	4000 V rms; (8mm creepage)
Coil to Frame:	4000 V rms
Across Open Contacts:	1000 V rms
Contact To Frame:	4000 V rms

### TEMPERATURE

Operation:	-30°C to +50°C. (AC), -30°C to +60°C. (DC)
Storage:	-40°C to +105°C

### LIFE EXPECTANCY

Electrical:	100,000 operations @ rated resistive load
Mechanical:	10,000,000 operations @ no load

### MISCELLANEOUS

Operating Position:	Any
Enclosure:	Polycarbonate dust cover
Weight:	85 grams approx.

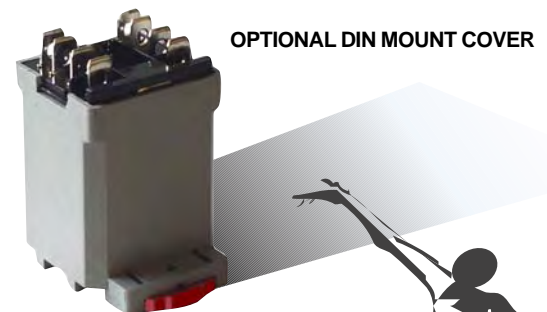
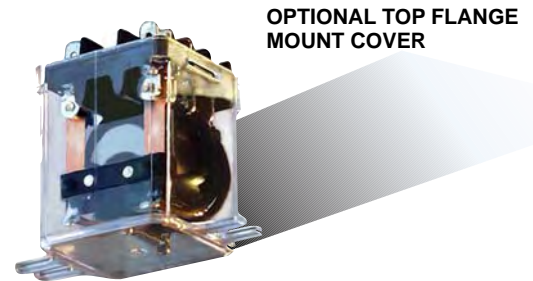
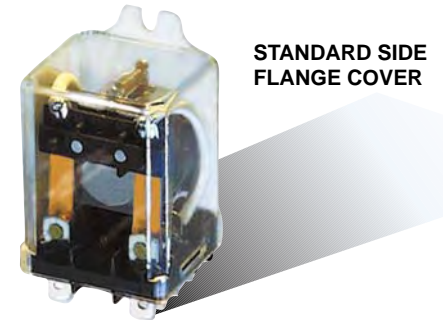

**DPDT, UP TO 30 AMPS  
UP TO 600 VAC OR 150 VDC**

**NEW**  
From The Market  
Leader in Industrial  
Relays

**OUTLINE DIMENSIONS**  
DIMENSIONS SHOWN IN INCHES & (MILLIMETERS).

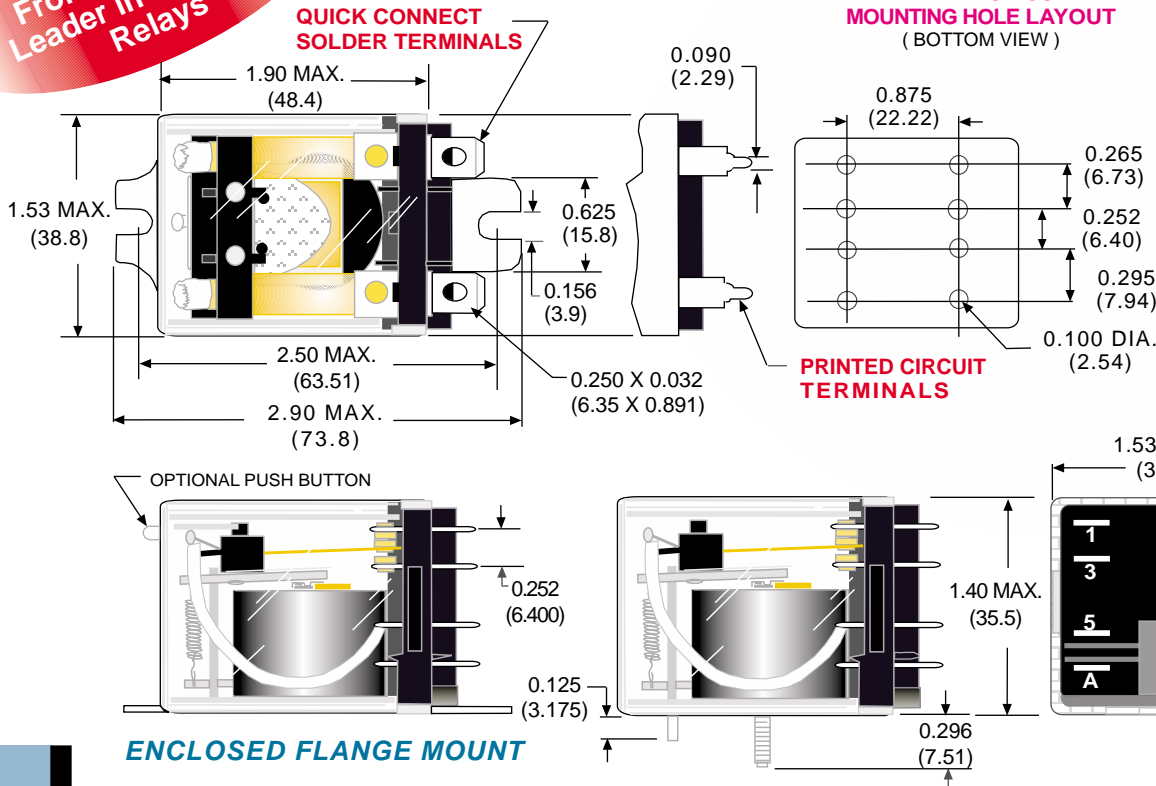

### ORDERING CODE FOR RELAYS

**F 300 XBXC1 LM-24D**

**TEMPERATURE RATING:**  
†† 130°C COIL: **CODE B**  
155°C COIL: **CODE F**

**CLASS:**

**CONTACT CONFIGURATION:**  
DPDT: **XBXC**

**CONSTRUCTION STYLE:**  
\* ENCLOSED, PLAIN COVER: **CODE C**  
ENCLOSED, FLANGE COVER: **CODE C1**  
ENCLOSED, 6-32 TAPPED CORE & ANTI-ROTATION TAB: **CODE C2**  
ENCLOSED 6-32 STUD & ANTI-ROTATION TAB: **CODE CS2**  
ENCLOSED TOP FLANGE MOUNT: **CODE C3**  
ENCLOSED DIN MOUNT: **CODE C4**

**TERMINAL STYLE:**  
† QUICK CONNECT SOLDER TERMINALS: **NO CODE**  
PRINTED CIRCUIT TERMINALS: **CODE T**

**OPTIONS:**  
BI - POLAR L.E.D. STATUS LAMP: **CODE L**  
PUSH BUTTON: **CODE M**  
MAGNETIC BLOWOUT: **CODE 69**  
DC COIL SUPPRESSION: **CODE V**  
AC COIL SUPPRESSION: **CODE V1**  
RECTIFIED COIL: **CODE V2**

**COIL VOLTAGE:**  
6, 12, 24, 120, 240 ADD "A" FOR AC COILS  
6, 12, 24, 48, 110-125, 220-250 ADD "D" FOR DC COILS

**OPTIONAL 6-32  
STUD OR TAPPED  
CORE WITH  
ANTI-ROTATION TAB.**

### WIRING DIAGRAM (VIEWED FROM PIN END)

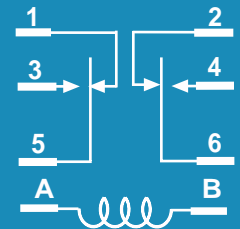

STANDARD PART NUMBERS	CONTACT CONFIGURATION	COIL MEASURED @ 25°C	
		NOMINAL INPUT VOLTAGE	NOMINAL RESISTANCE (OHMS)
<b>AC OPERATED, 30 AMP</b>			
300XBXC1-240A	DPDT	240 VAC, 50/60Hz	7200 Ω
300XBXC1-120A	DPDT	120 VAC, 50/60Hz	1700 Ω
300XBXC1-24A	DPDT	24 VAC, 50/60Hz	72 Ω
300XBXC1-12A	DPDT	12 VAC, 50/60Hz	18 Ω
<b>DC OPERATED, 30 AMP</b>			
300XBXC1-110D	DPDT	110 VDC	10,000 Ω
300XBXC1-24D	DPDT	24 VDC	470 Ω
300XBXC1-12D	DPDT	12 VDC	51 Ω
<b>DC OPERATED, 30 AMP WITH MAGNETIC BLOWOUT</b>			
300XB69C1-125D	DPDT	110 VDC	10,000 Ω
300XB69C1-24D	DPDT	24 VDC	470 Ω
300XB69C1-12D	DPDT	12 VDC	51 Ω

\* Note: Code C recommended to be used with printed circuit terminals only.  
†† Standard coil temperature Rating. Code letter not required in part number.  
Add code letter required in part number when a higher nonstandard coil temperature rating is required.

## UL CONTACT LOAD RATINGS TABLE

LOAD	LOAD VOLTAGE	SPST		SPDT		OPERATIONS
		N.O. LOAD	N.O. LOAD	N.C. LOAD	N.C. LOAD	
<b>GENERAL PURPOSE</b>	240 VAC	30 AMP	30 AMP	15 AMP		100,000
<b>RESISTIVE</b>	28 VDC	30 AMP	30 AMP	10 AMP		100,000
<b>MOTOR</b>	125 VAC	1 HP	1 HP	1/4 HP		1,000
	240 VAC	2 HP	2 HP	1/2 HP		6,000
<b>FLA/LRA ‡</b>	120 VAC	22/98 AMP	22/98 AMP	-		100,000
	240 VAC	30/80 AMP	30/80 AMP	12/30 AMP		30,000
<b>TUNGSTEN</b>	240 VAC	TV - 5	TV - 5	-		25,000
<b>BALLAST</b>	277 VAC	10 AMP	10 AMP	3 AMP		6,000
<b>PILOT DUTY</b>	240 VAC	470 VA	470 VA	275 VA		6,000

‡ FLA = Full load amps, LRA = Locked rotor amps.

## SPST-N.O. & SPDT, 30 AMPS

**cULus**  
UL Recognized  
File No. E43641

**CLASS "F" INSULATION 155 °C.**  
**FLANGE MOUNTED. EPOXY SEALED**  
**WITH REMOVABLE TAPE SEAL OVER**  
**VENT HOLE (REMOVED AFTER CLEANING)**

## GENERAL SPECIFICATIONS

### COIL

Pull-in Voltage: 80% of nominal voltage or less for AC coils, 75% of nominal voltage or less for DC coils  
Dropout Voltage: 10% of nominal voltage or more  
Max. Coil Voltage: 120% max.  
Power Consumption: 2.8 watts max.  
Insulation System: Class "F" (155°C)  
Coil Resistance: ±10% measured @ 25°C  
Duty: Continuous

### CONTACT

Contact Material: Silver alloy  
Switching Voltage: 277 VAC, 28 VDC max.  
Contact Resistance: 75 milliohms @ 1 amp rated current  
Minimum Load: 1 amp, 5 VDC, 12 VAC

### TIMING

Operate Time: DC: 15 mS typ. Including bounce  
Release Time: DC: 15 mS typ. Including bounce

### DIELECTRIC STRENGTH

Contacts to Coil: 2500 V rms  
Between Open Contacts: 1500 V rms  
Insulation Resistance: 1000 mΩ min. @ 500 VDC, 25°C 50% RH

### TEMPERATURE

Operating: -55°C to +85°C  
Storage: -55°C to +155°C

### VIBRATION RESISTANCE

Functional: 10 to 55Hz 1.65 mm max.  
No contact opening > 100 uS

### SHOCK RESISTANCE

Functional: 10 g's for 11 mS, no contact opening > 100 μS  
Mechanical: 100 g's

### LIFE EXPECTANCY

Electrical: 100,000 operations @ rated resistive load  
Mechanical: 10,000,000 operations @ no load

### MISCELLANEOUS

Operating Position: Any  
Enclosure: Epoxy sealed immersion cleanable suitable for automatic circuit board processing, max. Exposure soldering temperature is 4 sec. @ 500°F  
Enclosure: 94V-O flammability rating  
Terminals: 0.25" quick connect & safety wells accept insulated female quick connect terminals  
Weight: 33 grams approx.

MEETS UL 508,  
UL 873 AND  
UL 1950 - 1/8"  
THRU AIR - 1/4"  
OVER SURFACE

STANDARD FLANGE COVER

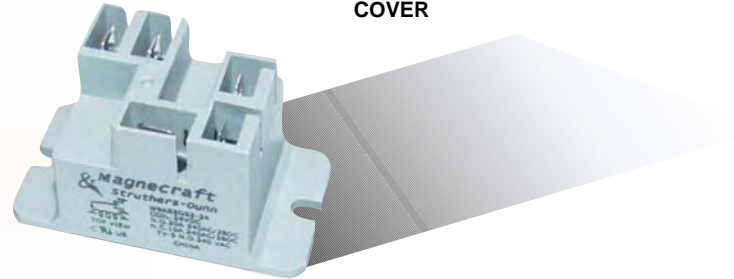

OPTIONAL DIN ADAPTER 16-9A DIN-1

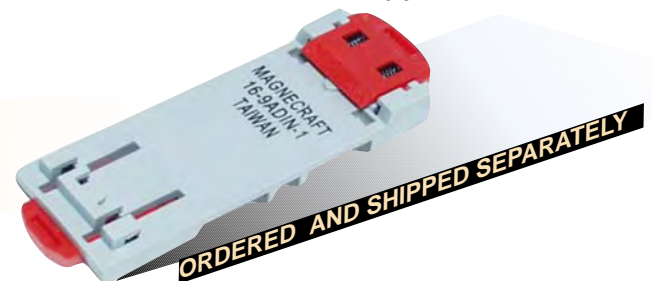

**SPST-N.O. & SPDT 30 AMPS**

**OUTLINE DIMENSIONS**

DIMENSIONS SHOWN IN INCHES & (MILLIMETERS).

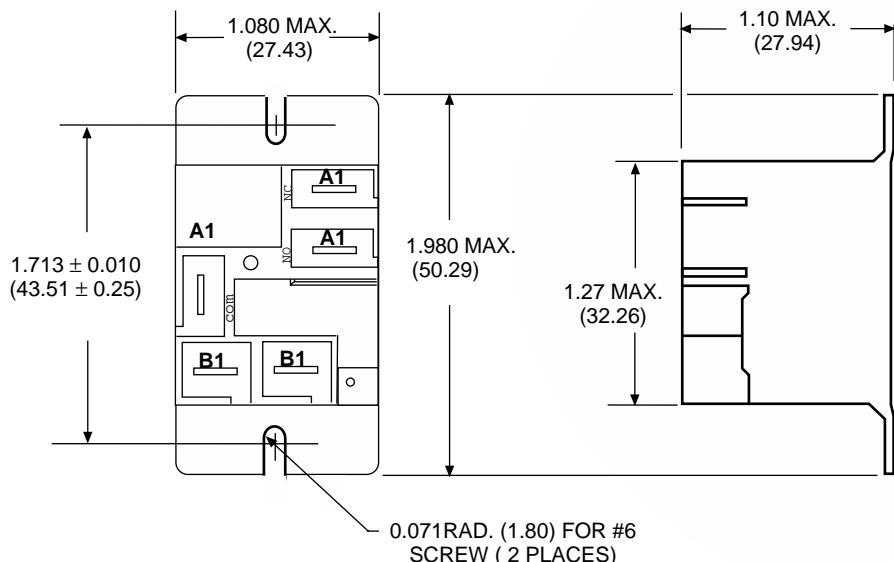

**A1 = 0.250 X 0.032 (6.35 X 0.81) Quick Connect Terminal**  
**B1 = 0.187 x 0.020 (4.78 x 0.508) Quick Connect Terminal**



**WIRING DIAGRAM**  
(BOTTOM VIEW)

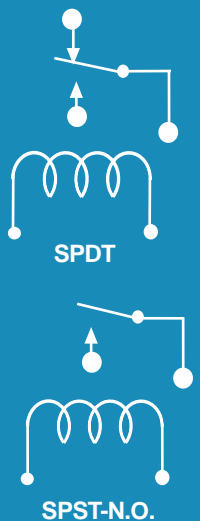

**COIL MEASURED @ 25°C**

STANDARD PART NUMBERS	CONTACT CONFIGURATION	NOMINAL INPUT VOLTAGE	NOMINAL RESISTANCE (OHMS)
<b>FLANGE MOUNT, 30 AMP</b>			
W9AS1D52-5	SPST-NO	5 VDC	25 Ω
W9AS1D52-12	SPST-NO	12 VDC	144 Ω
W9AS1D52-24	SPST-NO	24 VDC	576 Ω
W9AS1D52-110	SPST-NO	110 VDC	12100 Ω
<b>FLANGE MOUNT, 20 AMP</b>			
W9AS5D52-5	SPDT	5 VDC	25 Ω
W9AS5D52-12	SPDT	12 VDC	144 Ω
W9AS5D52-24	SPDT	24 VDC	576 Ω
W9AS5D52-110	SPDT	110 VDC	12100 Ω
<b>FLANGE MOUNT, 30 AMP</b>			
W9AS1A52-24	SPST-NO	24 VAC	
W9AS1A52-120	SPST-NO	120 VAC	
W9AS1A52-240	SPST-NO	240 VAC	
<b>FLANGE MOUNT, 20 AMP</b>			
W9AS5A52-24	SPDT	24 VAC	
W9AS5A52-120	SPDT	120 VAC	
W9AS5A52-240	SPDT	240 VAC	

## UL CONTACT LOAD RATINGS TABLE

RATING	LOAD VOLTAGE	DPST-N.O. & DPDT	DPDT	OPERATIONS
		N.O. LOAD	N.C. LOAD	
RESISTIVE LOAD	120/277 VAC	30 AMP	3 A MP	6,000
	28 VDC	20 AMP	3 A MP	100,000
MOTOR	120 VAC	1 HP	-	1000
	240 VAC	3 HP	-	1000
TUNGSTEN LRA/FLA‡	120 VAC	TV-10	-	25,000
	240 VAC	96/22 110/25.3	-	30,000
PILOT DUTY	240 VAC	3 AMP	-	6,000

## DPST-N.O. & DPDT 30 AMPS



UL Recognized  
File No. E43641

Note:

‡ FLA = full load amps, LRA = Locked rotor amps.

## GENERAL SPECIFICATIONS

### COIL

Pull-in Voltage: 80% of nominal voltage or less for AC coils, 75% of nominal voltage or less for DC coils  
 Dropout Voltage: 10% of nominal voltage or more  
 Max. Operating Frequency: 14 operations per minute  
 Nominal Power: AC coil: 4.0 VA, DC coil: 1.7W  
 Insulation System: Class "F" (155°C)  
 Coil Resistance: ±10% measured @ 25°C  
 Duty: Continuous

### CONTACT

Contact Material: Silver alloy  
 Contact Load Ratings: See: "UL CONTACT LOAD RATINGS TABLE"  
 Contact Resistance: 100, 000, 000 @ initial rated current (switched)  
 Minimum Load: N.O. 500 mA @ 12 VAC/VDC  
 N.C. 100 mA @ 6 VAC/VDC

### TIMING

Operate Time: DC: 15 mS typ. 25ms W/ Bounce  
 Release Time: DC: 10 mS typ. 25 ms W/ Bounce

### DIELECTRIC STRENGTH

Between Open Contacts: 1500 V rms  
 Contacts to Coil: 4000V rms  
 Insulation Resistance: 10<sup>3</sup> meg Ω min. @ 500 VDC, 25°C 50% RH

### TEMPERATURE

Operating: AC coil rectified: -40°C to +85°C, DC: -40°C to +85°C  
 Storage: -55°C to +155°C

### VIBRATION RESISTANCE

Functional: 0.065 (1.65 mm) double  
 Amplitude -10 thru 55 Hz

### SHOCK RESISTANCE

Functional: 10 g's for 11 mS, 1/2 sign wave pulse with no contact opening > 100µs  
 Mechanical: 100 g's for 11 mS, 1/2 sine wave pulse

### LIFE EXPECTANCY

Electrical: 100,000 operations @ rated resistive load  
 Mechanical: 5,000,000 operations @ no load

### MISCELLANEOUS

Operating Position: Any  
 Enclosure: Epoxy sealed immersion cleanable tape sealed plastic cover  
 Flammability: 94V-O flammability rating  
 Weight: 86 grams approx.

**CLASS "F" INSULATION 155 °C.**  
**EPOXY SEALED WITH REMOVABLE**  
**TAPE SEAL OVER VENT HOLE**  
**(REMOVED AFTER CLEANING)**



STANDARD FLANGE COVER

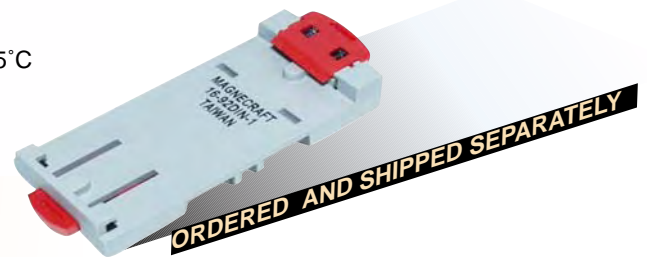

OPTIONAL DIN ADAPTER  
16-92 DIN-1

MEETS UL 873  
AND UL 508  
SPACING - (8MM)  
THRU AIR, (9.5 MM)  
OVER SURFACE





DPST-N.O. & DPDT 30 AMPS

**OUTLINE DIMENSIONS**  
DIMENSIONS SHOWN IN INCHES & (MILLIMETERS).

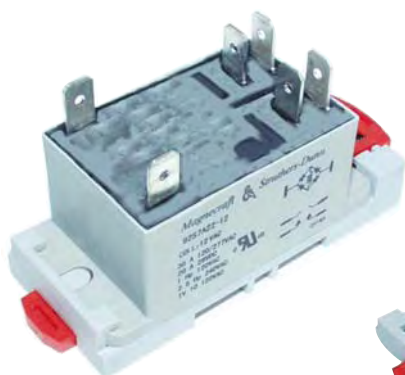
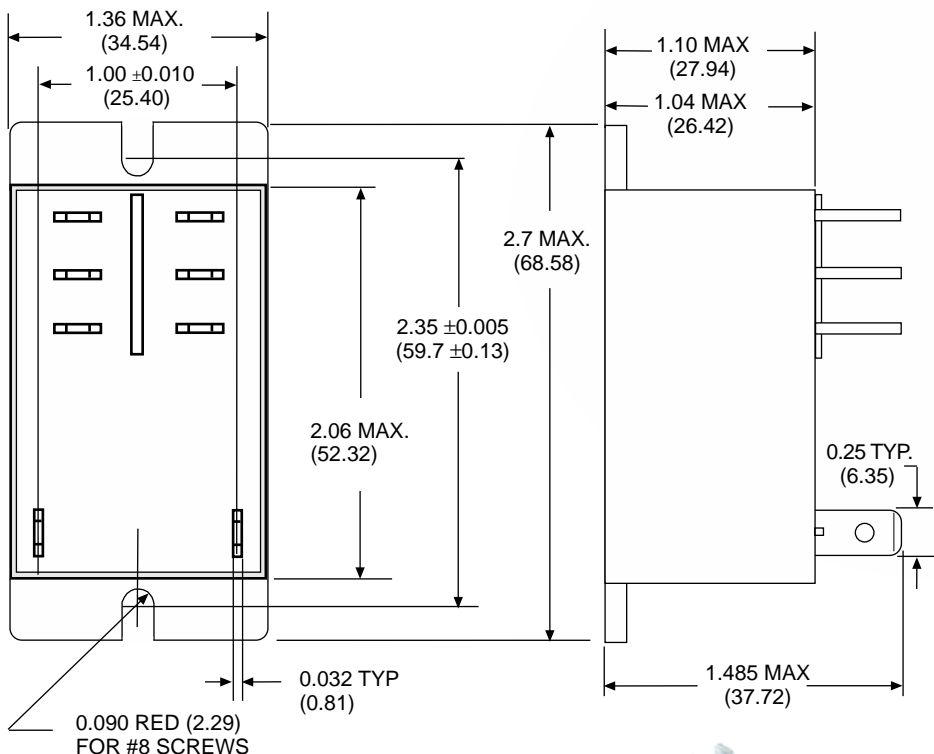

**WIRING DIAGRAM**

(VIEWED FROM PIN END)



DPST-N.O.

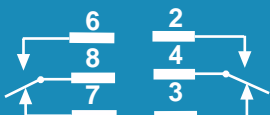

DPDT

STANDARD PART NUMBERS	COIL MEASURED @ 25°C		
	CONTACT CONFIGURATION	NOMINAL INPUT VOLTAGE	NOMINAL RESISTANCE (OHMS)
<b>AC OPERATED COIL FLANGE MOUNT, 30 AMP</b>			
W92S7A22-24	DPST-NO	24 VAC	-
W92S7A22-120	DPST-NO	120 VAC	-
W92S7A22-240	DPST-NO	240 VAC	-
W92S11A22-24	DPDT	24 VAC	-
W92S11A22-120	DPDT	120 VAC	-
W92S11A22-240	DPDT	240 VAC	-
<b>DC OPERATED COIL FLANGE MOUNT, 30 AMP</b>			
W92S7D22-12	DPST-NO	12 VDC	86 Ω
W92S7D22-24	DPST-NO	24 VDC	350 Ω
W92S7D22-110	DPST-NO	110 VDC	7,255 Ω
W92S11D22-12	DPDT	12 VDC	86 Ω
W92S11D22-24	DPDT	24 VDC	350 Ω
W92S11D22-110	DPDT	110 VDC	7,255 Ω

**UL CONTACT LOAD RATINGS TABLE**

POLES	CURRENT OR HORSE POWER	LOAD VOLTAGE	LOAD VOLTAGE FREQUENCY	TYPE OF LOAD	MINIMUM LOAD
<b>1 POLE THRU 6 POLES</b>	5 AMP	120 VAC	50/60 Hz	RESISTIVE	
	5 AMP	28 VDC	DC	RESISTIVE	50 mA, 6 VDC
	3 AMP	120 VAC	50/60 Hz	RESISTIVE	
	3 AMP	28 VDC	DC	RESISTIVE	10 mA, 6 VDC

**DPDT THRU 6PDT,  
3 & 5 AMPS**

UL Recognized  
File No. E52197



168986

**GENERAL SPECIFICATIONS****COIL**

Pull-in Voltage :	80% of nominal voltage or less
Dropout Voltage:	DC-10% of nominal voltage or more
Max. Voltage :	110%
Resistance:	±10% measured @ 25°C
Coil Power:	0.5 to 1.5 watts DC, 1.5 VA to 2 VA (60Hz) AC @ 25°C.
Max. Coil Dissipation:	2.2 watts @ 25°C.
Duty:	Continuous

**CONTACTS**

Contact Material:	Silver gold overlay
Coil Resistance:	50 megohms max.
Contact Rating:	See "UL CONTACT LOAD RATING TABLE"

**CAPACITANCE**

Between Contacts:	2 pf, typ.
Contacts to Coil:	2 pf, typ.
Contacts to Frame:	30 pf, typ.

**TIMING**

Operate Time:	DPDT=12 mS, 4PDT=14 mS, 6PDT=16 mS,
Release Time:	8 mS

**DIELECTRIC STRENGTH**

Contacts to Coil:	1500 V rms
Coil to Frame:	1000 V rms
Across Open Contacts:	500 V rms
Contacts to Frame:	1500 V rms
Insulation Resistance:	1000 megohms @ 500 VDC

**TEMPERATURE**

Operating:	-55°C to +70°C
Storage:	-55°C to +105°C

**LIFE EXPECTANCY**

Electrical:	200,000 operations @ rated resistive load
Mechanical:	1,000,000 operations @ no load

**MISCELLANEOUS**

Operating Position:	Any
Insulation Material	Molded plastic
Enclosure:	Polycarbonate dust cover
Weight:	22 to 40 grams approx.

Standard **Class 67** miniature industrial relays are designed for applications requiring DPDT to 6PDT contacts where space and weight are of prime importance. Shatter resistant, see-thru plastic covers are utilized to protect against dust, tampering and electrical shock. The 67T models have Bifurcated Contacts and are designed for low level switching applications.

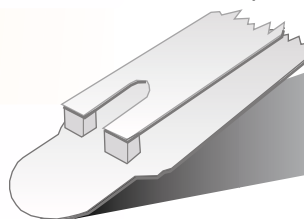
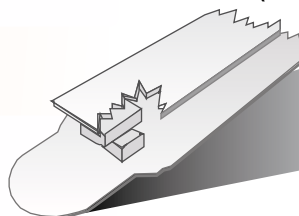
**BIFURCATED CONTACTS  
(LOW LEVEL APPLICATIONS)****STANDARD CONTACTS  
(5 AMP CROSS BAR)**

**Mating Sockets**  
**70-303-1, 70-305-1, 70-307-1: SOLDER**  
**70-304-1, 70-306-1, 70-308-1:**  
**PRINTED CIRCUIT**  
 See section 8, page 23, 24



**DPDT THRU 6PDT, 3 & 5 AMPS**

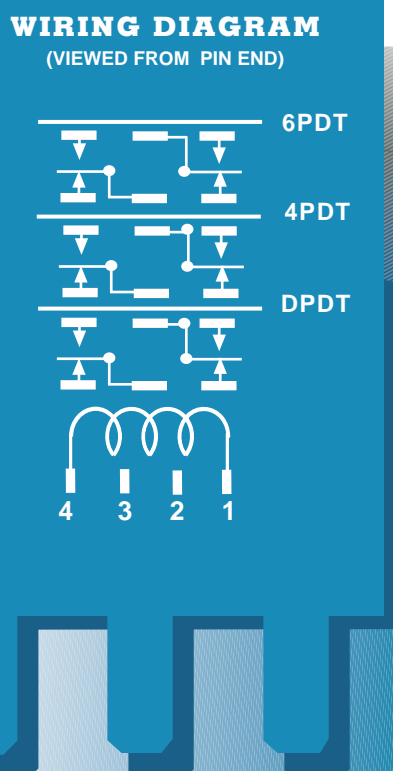
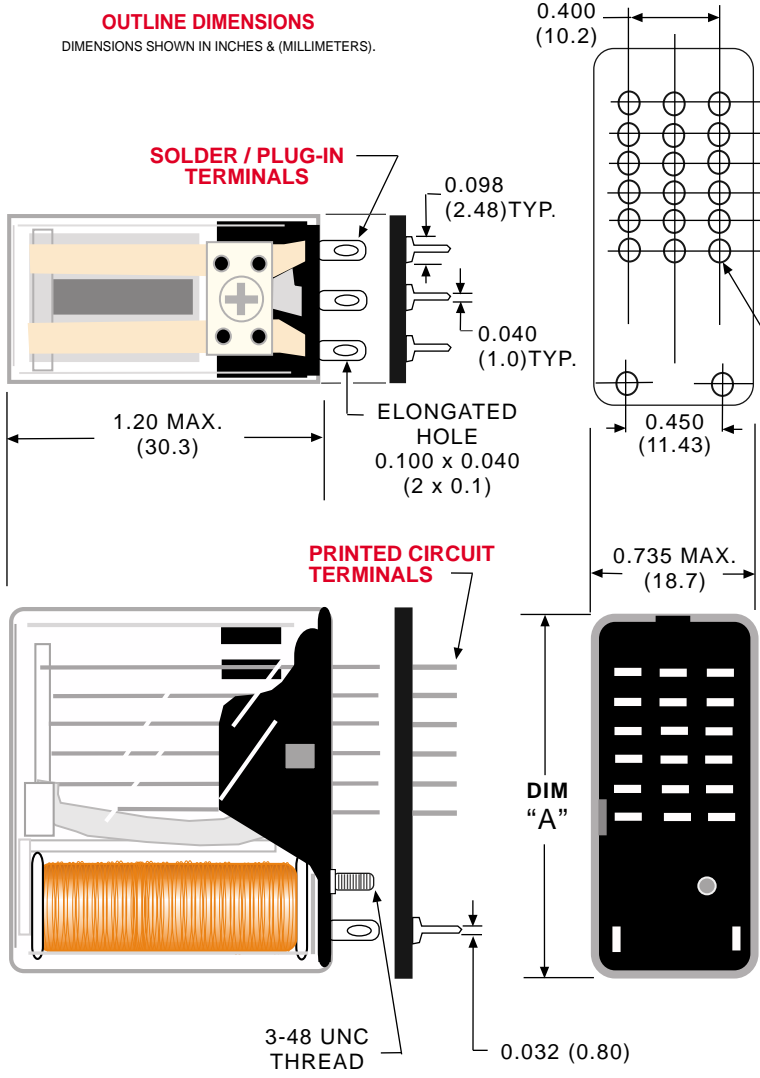

**DIMENSIONS**

CONTACT CONFIGURATION	"A" DIM
6PDT	1.374 (34.9)
4PDT	1.156 (29.4)
DPDT	0.978 (24.8)

STANDARD PART NUMBERS	CONTACT CONFIGURATION	COIL MEASURED @ 25°C	
		NOMINAL INPUT VOLTAGE OR	NOMINAL RESISTANCE (OHMS)
<b>DC OPERATED COIL - SOLDER/PLUG-IN, 5 AMP</b>			
W67RCSX-1	DPDT	5 VDC	52 Ω
W67RCSX-2	DPDT	12 VDC	185 Ω
W67RCSX-3	DPDT	24 VDC	700 Ω
W67RCSX-4	DPDT	48 VDC	2,500 Ω
W67RCSX-5	DPDT	110 VDC	15,000 Ω
W67RCSX-6	4PDT	5 VDC	52 Ω
W67RCSX-7	4PDT	12 VDC	185 Ω
W67RCSX-8	4PDT	24 VDC	700 Ω
W67RCSX-9	4PDT	48 VDC	2,500 Ω
W67RCSX-10	4PDT	110 VDC	15,000 Ω
W67RCSX-12	6PDT	12 VDC	90 Ω
W67RCSX-13	6PDT	24 VDC	430 Ω
<b>DC OPERATED COIL-BIFURCATED CONTACTS, 3 AMP</b>			
W67TRCSX-2	DPDT	12 VDC	185 Ω
W67TRCSX-3	DPDT	24 VDC	700 Ω
W67TRCSX-7	4PDT	12 VDC	185 Ω
W67TRCSX-8	4PDT	24 VDC	700 Ω
W67TRCSX-12	6PDT	12 VDC	90 Ω
W67TRCSX-13	6PDT	24 VDC	430 Ω
<b>DC OPERATED PRINTED CIRCUIT, 5 AMP</b>			
W67RPCX-2	DPDT	12 VDC	185 Ω
W67RPCX-3	DPDT	24 VDC	700 Ω
W67RPCX-7	4PDT	12 VDC	185 Ω
W67RPCX-8	4PDT	24 VDC	700 Ω
W67RPCX-12	6PDT	12 VDC	90 Ω
W67RPCX-13	6PDT	24 VDC	430 Ω
<b>AC OPERATED COIL - SOLDER/PLUG-IN, 5 AMP</b>			
W67ARCSX-5	DPDT	120 VAC, 50/60Hz	9000 Ω
W67ARCSX-10	4PDT	120 VAC, 50/60Hz	8000 Ω
W67ARCSX-15	6PDT	120 VAC, 50/60Hz	8000 Ω
<b>DC OPERATED COIL ULTRA SENSITIVE - SOLDER/PLUG-IN, 3 AMP</b>			
W67SCSX-1	DPDT	9.4 MADC	1,000 Ω
W67SCSX-2	DPDT	6.4 MADC	2,500 Ω
W67SCSX-3	DPDT	4.5 MADC	5,000 Ω
W67SCSX-6	4PDT	13.7 MADC	1,000 Ω
W67SCSX-7	4PDT	9.1 MADC	2,500 Ω
W67SCSX-8	4PDT	6.5 MADC	5,000 Ω

RETROFITS POTTER & BRUMFIELD R10.  
SEE END OF SECTION 1 FOR CROSS REFERENCE

**12 & 14 PIN, 10 AMPS**

## UL CONTACT LOAD RATINGS TABLE

POLES	CURRENT OR HORSE POWER	LOAD VOLTAGE	LOAD VOLTAGE FREQUENCY	TYPE OF LOAD
ALL STYLES	10 AMP	120 VAC	50/60 Hz	RESISTIVE
	5 AMP	240 VAC	50/60 Hz	RESISTIVE
	10 AMP	28 VDC	DC	RESISTIVE
	0.5 AMP	125 VDC	DC	RESISTIVE
	3 AMP	120 VAC	50/60 Hz	INDUCTIVE
	1 AMP	240 VAC	50/60 Hz	INDUCTIVE
	3 AMP	28 VDC	DC	INDUCTIVE
	0.1 AMP	125 VDC	DC	INDUCTIVE
<b>SUFFIX "69" WITH BLOWOUT MAGNET FOR DC SWITCHING (NOT UL OR CSA)</b>				
SPST-NO	1.5 AMP	125 VDC	DC	RESISTIVE
SPST-NO-DM	4 AMP	125 VDC	DC	RESISTIVE
SPST-NO	0.5 AMP	250 VDC	DC	RESISTIVE
SPST-NO-DM	1.5 AMP	250 VDC	DC	RESISTIVE
SPST-NO	0.5 AMP	125 VDC	DC	INDUCTIVE
SPST-NO-DM	1.5 AMP	125 VDC	DC	INDUCTIVE
SPST-NO	150 mA	250 VDC	DC	INDUCTIVE
SPST-NO-DM	0.5 AMP	250 VDC	DC	INDUCTIVE

**cUL** us  
UL Recognized  
File No. E13224

**SP** 168986

**UL** LISTED 225G  
IND. CONT. EQ.  
C US

WHEN USED WITH  
SOCKETS  
27390 OR 33377

CURRENT LIMITED TO  
RATING OF RELAY OR  
SOCKET WHICHEVER  
IS LESS

**CONTACTS CAN CLOSE ON 30 AMP LOADS AND CARRY 10 AMPS CONTINUOUSLY AT VOLTAGES SHOWN IN UL CONTACT LOAD RATINGS TABLE.**

## COIL SPECIFICATIONS @ 25°C

AC RELAYS 50/60 HZ (COIL DATA @ 60HZ VOLTAGE)					DC RELAYS, 1.8 WATTS (2.5 W @ 125 VDC)			
Nominal Voltage	Resistance Ohms ±10%	Milliamperes		Impedance Ohms	Nominal Voltage	Resistance Ohms ±10%	Milliamperes	
		Inrush (Open)	Sealed (Pull-In)				Cold	Hot
6	1.1	1500	840	7.2	6	15.5	385	304
12	4.2	750	410	27	12	63.5	189	147
24	15.5	375	200	120	24 (28)*	250	96	77
120	540	75	40	2700	32	375	86	62
240	2100	32	17	13,400	115/125*	6200	20	16

\* 24 VDC AND 115 VDC RELAYS HAVE NAME PLATES STAMPED 24-28 AND 115-125 VDC RESPECTIVELY. THESE RELAYS OPERATE AT 80% OF THE LOWER VOLTAGES AND OPERATE WITHIN ALLOWABLE TEMPERATURE RISES AT 110% OF HIGHER VOLTAGES. 250 VDC: USE 125 VDC RELAY AND SERIES RESISTOR (6000 Ω, 5 W) NOT SUPPLIED.

## GENERAL SPECIFICATIONS

**COIL**  
Pull-in Voltage: 85% of nominal voltage or less for AC coils, 80% of nominal voltage or less for DC coils  
Max. Voltage: 110%  
Insulation System: Class "B" (130°C per UL standard 1446)

**CONTACTS**  
Contact Material: Silver alloy, gold diffused

**TIMING**  
Operate Time: 25 mS max. @ nominal voltage  
Release Time: 20 mS max. @ nominal voltage

**DIELECTRIC STRENGTH**  
All Mutually Insulated Points: 1500 V rms

**TEMPERATURE**  
Operation: -40°C to +60°C  
Storage: -40°C to +130°C

**LIFE EXPECTANCY**  
Electrical: 100,000 operations @ rated resistive load  
Mechanical: 10,000,000 operations @ no load

**MISCELLANEOUS**  
Operating Position: Vertical, contacts up  
Enclosure: Polycarbonate dust cover  
Weight: 241 grams approx.

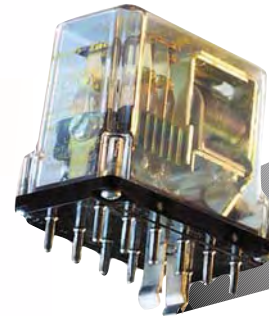

**Mating Sockets**  
27390D, 33377D: SCREW/PANEL/DIN  
See section 8, page 25



**12 & 14 PIN, 10 AMPS**

**OUTLINE DIMENSIONS**  
DIMENSIONS SHOWN IN INCHES & (MILLIMETERS).

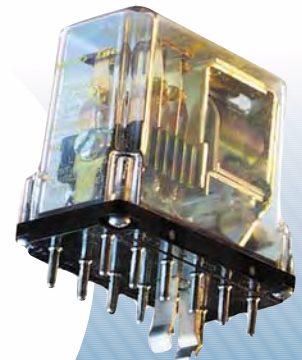
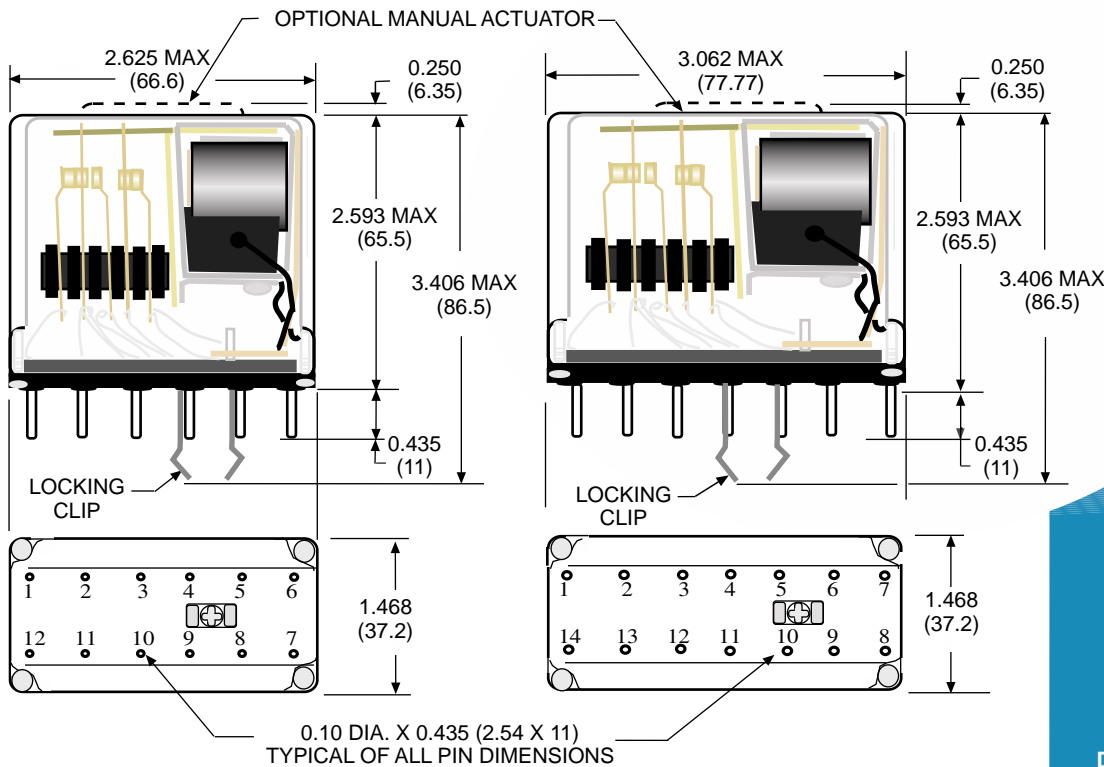

**WIRING DIAGRAMS**  
(VIEWED FROM PIN END)

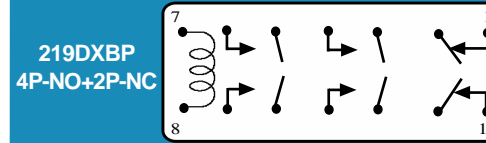
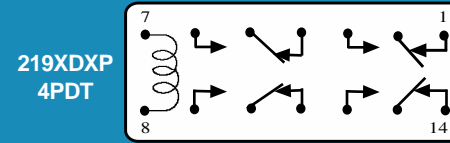
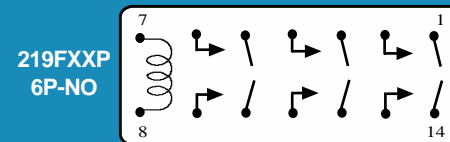
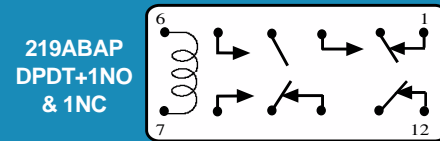
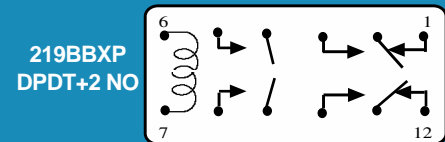
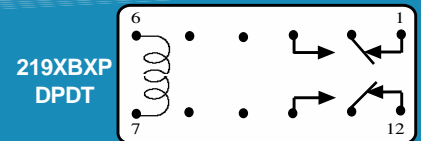

**ORDERING CODE FOR RELAYS**

**CLASS:** **219** **XBX** **P** **L-24D**

**CONTACT CONFIGURATION:**  
 DPDT: **XBX**  
 DPDT +1 POLE: NO & 1 POLE NC: **ABA**  
 2 POLE: NO & DPDT: **BBX**  
 4 PDT: **XXD**  
 6 POLE: NO: **FXX**  
 4 POLE: NO & 2 POLE: NC: **DXB**

**STANDARD FEATURES:**  
 POLYCARBONATE COVER: **CODE P**

**OPTIONAL FEATURES:**  
 STATUS LAMP: **CODE L**  
 MANUAL ACTUATOR: **CODE M**  
 BIFURCATED CONTACTS: **CODE 33**  
 PERM. MAGNET BLOWOUT: **CODE 69**

**COIL VOLTAGE:**  
 6, 12, 24, 120, 240 **ADD "A" FOR AC COILS**  
 6, 12, (24-28), 32, 115/125 **ADD "D" FOR DC COILS**

**COIL VOLTAGES & FREQUENCIES MUST BE SPECIFIED.**  
 Make before break and other contact configurations available limited only by the number of terminal pins. Contact factory.

**THE SERIES 219 GENERAL PURPOSE INDUSTRIAL PLUG-IN RELAYS FEATURE 12 PIN AND 14 PIN BASES. THE COIL IS ENCAPSULATED FOR PROTECTION. NUCLEAR QUALIFIED VERSIONS ARE AVAILABLE. CONSULT FACTORY.**

12 PIN MODELS	CONTACT CONFIGURATION	14 PIN MODELS	CONTACT CONFIGURATION
219BBXP	DPDT + 2 NO	219DXDP	4PDT
219XBXP	DPDT	219FXXP	6P-NO
219ABAP	DPDT + 1 NO & 1 NC	219DXBP	4P-NO + 2P-NC

**FEATURES****VACUUM BAKED & DRY NITROGEN FILLED**

REMOVES CONTAMINANTS AND PROVIDES A CLEAN &amp; DRY ATMOSPHERE FOR CONTACTS.

**HERMETICALLY SEALED METAL ENCLOSURE**

IDEAL FOR USE IN HAZARDOUS LOCATIONS. UL CERTIFIED FOR CLASS 1 DIVISION 2 GROUP A, B, C &amp; D HAZARDS.

**PLUG-IN STYLE MOUNTING**

WHEN USED WITH 70-464-1 OR 70-465-1 SOCKETS, THE 750H CAN BE DIN RAIL MOUNTED OR PANEL MOUNTED.

**BENEFITS****DPDT, 12 AMPS  
3PDT, 10 AMPS****UL** us  
UL Recognized  
File No. E43641**UL** LISTED 367G  
IND. CONT. EQ.  
C USWHEN USED WITH  
SOCKETS  
70-464-1 OR 70-465-1CURRENT LIMITED TO  
RATING OF RELAY OR  
SOCKET WHICHEVER  
IS LESS**GENERAL SPECIFICATIONS****COIL**

Pull-in Voltage:	85% of nominal voltage or less for AC coils, 80% of nominal voltage or less for DC coils
Dropout Voltage:	10% of nominal voltage or more
Max. Voltage:	110%
Resistance:	±10% measured @ 25°C
Coil Power:	1.2 watts DC, 2 VA to 2.75 VA (60Hz) AC @ 25°C.
Max. Coil Dissipation:	3.0 watts DC @ 25°C.
Duty:	Continuous

**CONTACTS**

Contact Material:	Silver alloy, gold flashed
Contact Rating:	10 amps, 120 VAC. 6 amps, 240 VAC 50/60Hz for 3 pole 12 amps, 120 VAC. 8 amps, 240 VAC 50/60Hz for 2 pole 1/3Hp 120 VAC, 1/2Hp 240 VAC. 10 amps, 30 VDC
Contact Resistance:	50 milliohms max. Initial at rated current

**TIMING**

Operate Time:	15 mS max @ nominal voltage
Release Time:	10 mS max @ nominal voltage

**DIELECTRIC STRENGTH**

Contacts to Coil:	1250 V rms
Across open Contacts:	500 V rms
Pole to Pole:	1250 V rms
Contacts to Frame:	1250 V rms
Insulation Resistance:	1000 megohms min. @ 500 VDC

**TEMPERATURE**

Operating:	-45°C to +55°C. (AC) -45°C +70°C. (DC)
Storage:	-45°C to +105°C

**VIBRATION RESISTANCE**

Functional:	6 g's, 10 to 55Hz (double amplitude)
-------------	--------------------------------------

**SHOCK RESISTANCE**

Functional:	5 g's
Mechanical:	20 g's

**LIFE EXPECTANCY**

Electrical:	100,000 operations @ rated resistive load
Mechanical:	5,000,000 operations @ no load

**MISCELLANEOUS**

Operating Position:	Any
Insulation Material:	Molded plastic
Enclosure:	Grey metal case, hermetically sealed
Weigh:	130 grams approx.

**UL GROUPS A, B, C & D CERTIFIED  
CLASS 1 DIVISION 2 FOR  
HAZARDOUS LOCATIONS****Mating Sockets****70-750D8-1, 70-750D11-1,  
70-464-1, 70-465-1: SCREW/DIN  
70-169-1, 70-170-1: SCREW/PANEL  
See Section 8, page 7 - 12**

**DPDT, 12 AMPS  
3PDT, 10 AMPS**

**NEW**  
From The Market  
Leader in Industrial  
Relays

**OUTLINE DIMENSIONS**  
DIMENSIONS SHOWN IN INCHES & (MILLIMETERS).

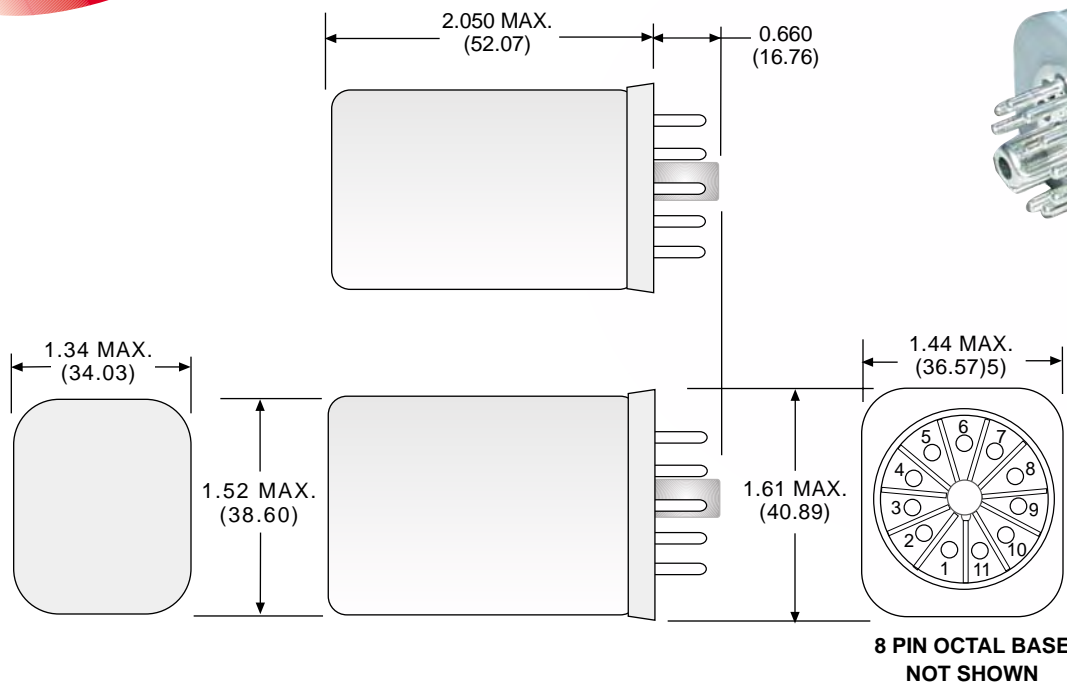

**WIRING DIAGRAMS**  
(VIEWED FROM PIN END)

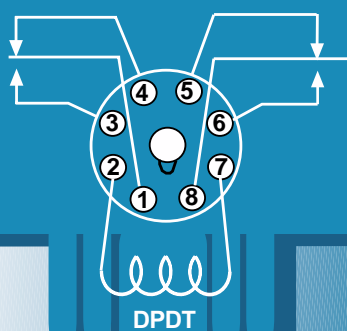
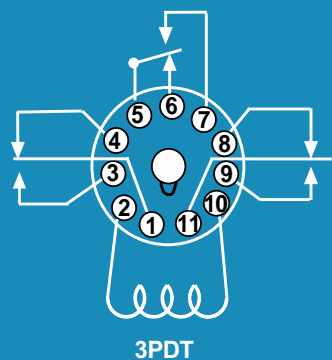

STANDARD PART NUMBERS	CONTACT CONFIGURATION	COIL MEASURED @ 25°C	
		NOMINAL INPUT VOLTAGE	NOMINAL RESISTANCE (OHMS)
<b>AC OPERATED - 8 PIN OCTAL, 12 AMP</b>			
750XBXH-12A	DPDT	12 VAC, 50/60Hz	72 Ω
750XBXH-24A	DPDT	24 VAC, 50/60Hz	1,700 Ω
750XBXH-120A	DPDT	120 VAC, 50/60Hz	9,100 Ω
<b>DC OPERATED - 8 PIN OCTAL, 12 AMP</b>			
750XBXH-12D	DPDT	12 VDC	120 Ω
750XBXH-24D	DPDT	24 VDC	470 Ω
750XBXH-110D	DPDT	110 VDC	10,000 Ω
<b>AC OPERATED - 11 PIN OCTAL, 10 AMP</b>			
750XCXH-12A	3PDT	12 VAC, 50/60Hz	72 Ω
750XCXH-24A	3PDT	24 VAC, 50/60Hz	1,700 Ω
750XCXH-120A	3PDT	120 VAC, 50/60Hz	9,100 Ω
<b>DC OPERATED - 11 PIN OCTAL, 10 AMP</b>			
750XCXH-12D	3PDT	12 VDC	120 Ω
750XCXH-24D	3PDT	24 VDC	470 Ω
750XCXH-110D	3PDT	110 VDC	10,000 Ω

**DPDT, 30 AMPS**

**BENEFITS**

**MAGNECRAFT: W21ACPX-2**

**MIDTEX: TYPE 136**

<b>CURRENT RATING:</b>	30 AMPS @ 120/240 VAC, 20 AMPS @ 28 VDC	15 AMPS @ 120 VAC, 15 AMPS @ 28 VDC
<b>HORSEPOWER RATING:</b>	1-1/2 HP @ 120 VAC, 2 HP @ 240 VAC	1/4HP @ 120 VAC, NOT UL RATED
<b>TUNGSTEN LOAD RATING:</b>	2.4 KW @ 240 VAC	1 KW @ 120/240 VAC
<b>ELECTRICAL LIFE @ RATED LOAD:</b>	200,000 OPERATIONS	100,000 OPERATIONS



**MANUFACTURED UNDER ISO 9002**

**EXCEEDS NEMA STD. TS 2-1992 APPROVED BY D.O.T FOR:**  
 California Minnesota  
 Georgia New York  
 Illinois Texas  
 Oregon Colorado  
 Maryland Missouri  
 North Carolina



**OUTLINE DIMENSIONS**  
 DIMENSIONS SHOWN IN INCHES & (MILLIMETERS).

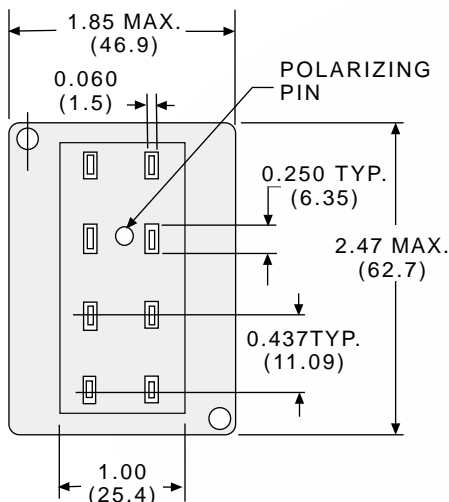
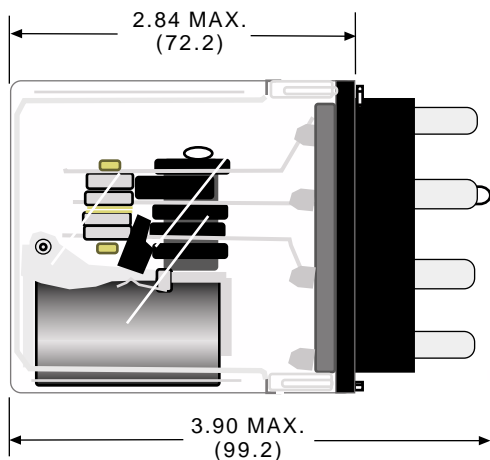

**BENEFITS OF RECTIFIED COIL DESIGN:**

1. Chatter Free Operation in Brownout Conditions Down to 85 VAC and Will not Overheat up to 140 VAC.
2. Less Power Consumption and Less Heating.

## GENERAL SPECIFICATIONS

**COIL**  
 Pull-in Voltage: 65% of nominal voltage @ 20°C or less for AC coils  
 Dropout Voltage: 10% of nominal voltage or more  
 Coil Insulation: Class "B" system (130°C per UL standard 1446)  
 Nominal Power: 4.0 VA

**CONTACTS**  
 Contact Material: Silver alloy  
 Contact Rating: 30 amps, 120/240 VAC (resistive) 25 amps, 120/240 VAC (CSA)  
 20 amps, 28 VDC (resistive) 1-1/2Hp, 120 VAC, 2Hp, 240 VAC  
 20 amps, 120 VAC (tungsten lamp)  
 10 amps, 240 VAC (tungsten lamp)

**DIELECTRIC STRENGTH**  
 Across Open Contacts: 500 V rms  
 Contact to Coil: 1500 V rms  
 Contact to Frame: 1500 V rms

**TEMPERATURE**  
 Operating: -40°C to +84°C  
 Storage: -40°C to +105°C

**LIFE EXPECTANCY**  
 Electrical: 200,000 operations @ 20 amps tungsten, 120 VAC  
 Mechanical: 5,000,000 operations @ no load

**MISCELLANEOUS**  
 Enclosure: Clear polycarbonate  
 Operating Position: Vertical, contacts up or horizontal  
 Weight: 204.7 grams approx.

**MOUNTING:**  
 FITS STANDARD  
 8 PIN JONES PLUG

**WIRING DIAGRAM**  
 (VIEWED FROM PIN END)

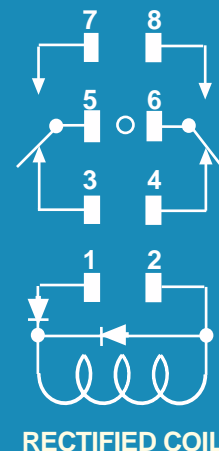

**SWITCHES TUNGSTEN LAMP LOADS UP TO 20 AMPS**

**COIL MEASURED @ 25°C**

STANDARD PART NUMBER	CONTACT CONFIGURATION	NOMINAL INPUT VOLTAGE	NOMINAL POWER
<b>AC RECTIFIED - PLUG-IN, 30 AMP</b>			
W21ACPX-2	DPDT	120 VAC, 50/60Hz	4.0 VA





# SECTION 1 CROSS REFERENCE GUIDE

MAGNECRAFT & STRUTHERS-DUNN	IDEC			
781XAXML-24A	RH1B-L-AC24			
781XAXML120A	RH1B-L-AC120			
781XAXML-240A	RH1B-L-AC240			
781XAXML-12D	RH1B-L-DC12			
781XAXML-24D	RH1B-L-DC24			
781XAXML-110D	RH1B-L-DC110			
781XAXTML-120A	RH1V2-L-AC120			
781XAXTML-12D	RH1V2-L-DC12			
781XAXTML-24D	RH1V2-L-DC24			
MAGNECRAFT & STRUTHERS-DUNN	IDEC			
781XAXC-24A	RH1B-U-AC24			
781XAXC-120A	RH1B-U-AC120			
781XAXC-24D	RH1B-U-DC24			
MAGNECRAFT & STRUTHERS-DUNN	TYCO / POTTER & BRUMFIELD	OMRON		
782DXH10-24A	KHS17A11-24	MY4H-US-24VAC		
782DXH10-120A	KHS17A11-120	MY4H-US-120VAC		
782DXH10-12D	KHS17D11-12	MY4H-US-12VDC		
782DXH10-24D	KHS17D11-24	MY4H-US-24VDC		
782DXH10-110D	KHS17D11-110	-		
782DXH21-120A	KHS17A12-120	-		
782DXH21-12D	KHS17D12-12	-		
782DXH21-24D	KHS17D12-24	-		
MAGNECRAFT & STRUTHERS-DUNN	FINDER	TYCO / SCHRACK (PT REPLACES ZT)		ALLEN-BRADLEY
782DX2M4L-24A	55.34.8024.20.54	PT570524	ZT570524	700-HC24A24-1-4
782DX2M4L-120A	55.34.8120.20.54	PT570615	ZT570615	700-HC24A1-1-4
782DX2M4L-240A	55.34.8240.20.54	PT570730	ZT570730	700-HC24A2-1-4
782DX2M4L-12D	55.34.9012.20.54	PT570012	ZT570012	700-HC24Z12-1-4
782DX2M4L-24D	55.34.9024.20.54	PT570024	ZT570024	700-HC24Z24-1-4
782DX2M4L-110D	55.34.9110.20.54	PT570110	ZT570110	700-HC24Z1-1-4
782XB2M4L-24A	56.32.8024.20.54	PT270524	ZT270524	
782XB2M4L-120A	56.32.8120.20.54	PT270615	ZT270615	
782XB2M4L-240A	56.32.8240.20.54	PT270730	ZT270730	
782XB2M4L-12D	56.32.9012.20.54	PT270012	ZT270012	
782XB2M4L-24D	56.32.9024.20.54	PT270024	ZT270024	
782XB2M4L-110D	56.32.9110.20.54	PT270110	ZT270110	
782XBXM4L-24A	55.32.8024.20.54	PT270524	ZT270524	
782XBXM4L-120A	55.32.8120.20.54	PT270615	ZT270615	
782XBXM4L-240A	55.32.8240.20.54	PT270730	ZT270730	
782XBXM4L-12D	55.32.9012.20.54	PT270012	ZT270012	
782XBXM4L-24D	55.32.9024.20.54	PT270024	ZT270024	
782XBXM4L-110D	55.32.9110.20.54	PT270110	ZT270110	
MAGNECRAFT & STRUTHERS-DUNN	IDEC	OMRON		
782XB2C-24A	RY2S-U-AC24V	MY2-AC24		
782XB2C-120A	RY2S-U-AC110/120V	MY2-AC120		

THE CROSS REFERENCE IS INTENDED TO MATCH FOOT PRINT, INTERNAL WIRING, AND CONTACT LOAD RATINGS. CONSTRUCTION FEATURES AND GENERAL SPECIFICATIONS SHOULD BE COMPARED IF EXACT REPLACEMENT IS REQUIRED.



# SECTION 1 CROSS REFERENCE GUIDE

MAGNECRAFT & STRUTHERS-DUNN	IDEC	OMRON			
782XBX2C-24D	RY2S-U-DC24V	MY2-DC24			
MAGNECRAFT & STRUTHERS-DUNN	IDEC				
782XBX3C-24A	RY22S-U-AC24V				
782XBX3C-120A	RY22S-U-AC110/120V				
782XBXC3-24D	RY22S-U-DC24V				
MAGNECRAFT & STRUTHERS-DUNN	IDEC				
783XCXM4L-24A	RH3B-ULC-AC24				
783XCXM4L-120A	RH3B-ULC-AC120				
783XCXM4L-240A	RH3B-ULC-AC240				
783XCXM4L-12D	RH3B-ULC-DC12				
783XCXM4L-24D	RH3B-ULC-DC24				
783XCXM4L-110D	RH3B-ULC-DC110				
783XCXTM4L-120A	RH3V2-ULC-AC120				
783XCXTM4L-12D	RH3V2-ULC-DC12				
783XCXTM4L-24D	RH3V2-ULC-DC24				
MAGNECRAFT & STRUTHERS-DUNN	IDEC	OMRON			
783XCXC-24A	RH3B-U-AC24	LY3-AC24			
783XCXC-120A	RH3B-U-AC120	LY3-AC120			
783XCXC-24D	RH3B-U-DC24	LY3-DC24			
MAGNECRAFT & STRUTHERS-DUNN	IDEC	OMRON			
784DXM4L-24A	RH4B-ULC-AC24	LY414N-AC24			
784DXM4L-120A	RH4B-ULC-AC120	LY414N-AC120			
784DXM4L-240A	RH4B-ULC-AC240	LY414N-AC240			
784DXM4L-12D	RH4B-ULC-DC12	LY414N-DC12			
784DXM4L-24D	RH4B-ULC-DC24	LY414N-DC24			
784DXM4L-110D	RH4B-ULC-DC110	LY414N-DC110			
784XDXTM4L-120A	RH4V2-ULC-AC120	-			
784XDXTM4L-12D	RH4V2-ULC-DC12	-			
784XDXTM4L-24D	RH4V2-ULC-DC24	-			
MAGNECRAFT & STRUTHERS-DUNN	IDEC	OMRON			
784DXC-24A	RH4B-U-AC24	LY4-AC24			
784DXC-120A	RH4B-U-AC120	LY4-AC120			
784DXC-24D	RH4B-U-DC24	LY4-DC24			
MAGNECRAFT & STRUTHERS-DUNN	TYCO / POTTER & BRUMFIELD	IDEC	OMRON	AROMAT	ALLEN - BRADLEY
W78ATCSX-2	KHAU17A96-12	RY42S-U-AC12V	MY4Z-AC12	HC4D-AC12	700-HC54A24
W78ATCSX-3	KHAU17A96-24	RY42S-U-AC24V	MY4Z-AC24	HC4D-AC24	700-HC54A1
W78ATCSX-5	KHAU17A96-120	RY42S-U-AC110/120V	MY4Z-AC120	HC4D-AC120	
W78ATCSX-6	KHAU17A96-240	RY42S-U-AC220/240V	MY4Z-AC240	HC4D-AC240	
W78TCSX-1	KHAU17D96-6	RY42S-U-DC6V	MY4Z-DC6	HC4D-DC6	700-HC54Z12
W78TCSX-2	KHAU17D96-12	RY42S-U-DC12V	MY4Z-DC12	HC4D-DC12	700-HC54Z24
W78TCSX-3	KHAU17D96-24	RY42S-U-DC24V	MY4Z-DC24	HC4D-DC24	

THE CROSS REFERENCE IS INTENDED TO MATCH FOOT PRINT, INTERNAL WIRING, AND CONTACT LOAD RATINGS. CONSTRUCTION FEATURES AND GENERAL SPECIFICATIONS SHOULD BE COMPARED IF EXACT REPLACEMENT IS REQUIRED.



# SECTION 1 CROSS REFERENCE GUIDE

MAGNECRAFT & STRUTHERS-DUNN	TYCO / POTTER & BRUMFIELD	IDEC	OMRON	AROMAT	ALLEN - BRADLEY
W78TCSX-5	* KHAU17D16-110	RY42S-U-DC100/110V	MY4Z-DC110	HC4D-DC110	700-HC14A12
W78ACSX-2	* KHAU17A11-12	RY4S-U-AC12V	MY4-AC12		700-HC14A24
W78ACSX-3	* KHAU17A11-24	RY4S-U-AC24V	MY4-AC24		700-HC14A1
W78ACSX-5	* KHAU17A11-120	RY4S-U-AC110/120V	MY4-AC120		700-HC14A2
W78ACSX-6	* KHAU17A11-240	RY4S-U-AC220/240V	MY4-AC240		700-HC14Z06
W78CSX-1	* KHAU17D11-6	RY4S-U-DC6V	MY4-DC6		700-HC14Z12
W78CSX-2	* KHAU17D11-12	RY4S-U-DC12V	MY4-DC12		700-HC14Z24
W78CSX-3	* KHAU17D11-24	RY4S-U-DC24V	MY4-DC24		700-HC14Z1
W78CSX-6	* KHAU17D11-110	RY4S-U-DC100/110V	MY4-DC110		
W78APCX-3	KHAE17A11-24	RY4V-U-AC24V	MY4-02-AC24		
W78APCX-5	KHAE17A11-120	RY4V-U-AC110/120V	MY4-02-AC120		
W78PCX-2	KHAE17D11-12	RY4V-U-DC12V	MY4-02-DC12		
W78PCX-3	KHAE17D11-24	RY4V-U-DC24V	MY4-02-DC24		
W78PCX-6	KHAE17D11-110	RY4V-U-DC100/110V	MY4-02-DC110		
W78KACSX-15	KHAU17A12-24	RY4S-U-AC24V		HC4-AC24	700-HC24A24
W78KACSX-17	KHAU17A12-120	RY4S-U-AC110/120V		HC4-AC120	700-HC24A1
W78KACSX-18	KHAU17A12-240	RY4S-U-AC220/240V		HC4-AC240	700-HC24A2
W78KCSX-12	KHAU17D12-12	RY4S-U-DC12V		HC4-DC12	700-HC24Z12
W78KCSX-13	KHAU17D12-24	RY4S-U-DC24V		HC4-DC24	700-HC24Z24
W78ARCSX-7	K10P11A15-6	RH2B-U-AC6V	LY2-AC6		700-HF32A06
W78ARCSX-9	K10P11A15-24	RH2B-U-AC24V	LY2-AC24		700-HF32A24
W78ARCSX-11	K10P11A15-120	RH2B-U-AC110/120V	LY2-AC120		700-HF32A1
W78ARCSX-12	K10P11A15-240	RH2B-U-AC220/240V	LY2-AC240		700-HF32A2
W78RCSX-6	K10P11D15-6	RH2B-U-DC6V	LY2-DC6		700-HF32Z06
W78RCSX-7	K10P11D15-12	RH2B-U-DC12V	LY2-DC12		700-HF32Z12
W78RCSX-8	K10P11D15-24	RH2B-U-DC24V	LY2-DC24		700-HF32Z24
W78RCSX-9	K10P11D15-48	RH2B-U-DC48V	LY2-DC48		700-HF32Z48
W78RCSX-10	K10P11D15-110	RH2B-UL-DC100/110V	LY2-DC110		700-HF32Z1
W78ARPCX-5	K10P11A55-120	RH2V2-U-AC110/120V	LY2-0-AC120		
W78ARPCX-6	K10P11A55-240	RH2V2-U-AC220/240V	LY2-0-AC240		
W78RPCX-1	K10P11D55-6	RH2V2-U-DC6V	LY2-0-DC6		
W78RPCX-2	K10P11D55-12	RH2V2-U-DC12V	LY2-0-DC12		
W78RPCX-3	K10P11D55-24	RH2V2-U-DC24V	LY2-0-DC24		
W78ARCSX-108			LY1-AC12		
W78ARCSX-109			LY1-AC24		
W78ARCSX-111			LY1-AC120		
W78ARCSX-112			LY1-AC240		
W78ARNCSX-8			LY1N-AC24		
W78ARNCSX-9			LY1N-AC120		
W78ARNCSX-10			LY1N-AC240		
W78RCSX-96			LY1-DC6		
W78RCSX-97			LY1-DC12		
W78RCSX-98			LY1-DC24		
W78RCSX-100			LY1-DC110		
W78RNCSX-10			LY1N-DC24		
W78ARPCX-81			LY1-0-AC12		
W78ARPCX-82			LY1-0-AC24		

THE CROSS REFERENCE IS INTENDED TO MATCH FOOT PRINT, INTERNAL WIRING, AND CONTACT LOAD RATINGS. CONSTRUCTION FEATURES AND GENERAL SPECIFICATIONS SHOULD BE COMPARED IF EXACT REPLACEMENT IS REQUIRED.

\* 91 STYLE SAME AS 11 STYLE EXCEPT NO STUD



# SECTION 1 CROSS REFERENCE GUIDE

MAGNECRAFT & STRUTHERS-DUNN	OMRON			
W78ARPCX-84	LY1-0-AC120			
W78RPCX-79	LY1-0-DC12			
W78RPCX-83	LY1-0-DC24			
W78RPCX-85	LY1-0-DC110			
MAGNECRAFT & STRUTHERS-DUNN	TYCO / POTTER & BRUMFIELD	TYCO / SCHRACK	OMRON	ALLEN - BRADLEY
750BXM4L-24A	KRPA-11ANFP-24	MT228024	MK2PN-S-AC24	700HA32A24-1-4
750BXM4L-120A	KRPA-11ANFP-120	MT228115	MK2PN-S-AC120	700HA32A1-1-4
750BXM4L-240A	KRPA-11ANFP-240	MT228230	MK2PN-S-AC240	700HA32A2-1-4L
750BXM4L-12D	KRPA-11DNFP-12	MT223012	MK2PN-S-DC12	700HA32Z12-1-4
750BXM4L-24D	KRPA-11DNFP-24	MT223024	MK2PN-S-DC24	700HA32Z24-1-4
MAGNECRAFT & STRUTHERS-DUNN	TYCO / POTTER & BRUMFIELD	TYCO / SCHRACK	OMRON	ALLEN - BRADLEY
750BXM4L-110D	KRPA-11DNFP-110	MT223110	MK2PN-S-DC110	700HA32Z1-1-4
750CXM4L-24A	KRPA-14ANFP-24	MT328024	MK3PN-S-AC24	700HA33A24-1-4
750CXM4L-120A	KRPA-14ANFP120	MT328115	MK3PN-S-AC120	700HA33A1-1-4
750CXM4L-240A	KRPA-14ANFP-240	MT328230	MK3PN-S-AC240	700HA33A2-1-4L
750CXM4L-12D	KRPA-14DNFP-12	MT323012	MK3PN-S-DC12	700HA33Z12-1-4
750CXM4L-24D	KRPA-14DNFP-24	MT323024	MK3PN-S-DC24	700HA33Z24-1-4
750CXM4L-110D	KRPA-14DNFP-110	MT323110	MK3PN-S-DC110	700HA33Z1-1-4
MAGNECRAFT & STRUTHERS-DUNN	TYCO / POTTER & BRUMFIELD	IDEC		DELTRON
A314XBX48P-24A	KRPA-11AG (or GF) -24	RR2P-U-AC24V		20108-82
A314XBX48P-120A	KRPA-11AG (or GF) -120	RR2P-U-AC120V		20108-84
A314XBX48P-240A	KRPA-11AG (or GF) -240	RR2P-U-AC240V		20108-85
A314XCX48P-24A	KRPA-14AG (or GF) -24	RR3PA-U-AC24V		20110-82
A314XCX48P-120A	KRPA-14AG (or GF) -120	RR3PA-U-AC120V		20110-84
A314XCX48P-240A	KRPA-14AG (or GF) -240	RR3PA-U-AC240V		20110-85
A314XBX48P-12D	KRPA-11DG (or GF) -12	RR2P-U-DC12V		20114-81
A314XBX48P-24D	KRPA-11DG (or GF) -24	RR2P-U-DC24V		20114-82
A314XCX48P-12D	KRPA-14DG (or GF) -12	RR3PA-U-DC12V		20116-81
A314XCX48P-24D	KRPA-14DG (or GF) -24	RR3PA-U-DC24V		20116-82
MAGNECRAFT & STRUTHERS-DUNN	TYCO / POTTER & BRUMFIELD	ALLEN - BRADLEY		
788BXM4L-24A	KUP-11A45 (or F) -24	700HB32A24-1-4		
788BXM4L-120A	KUP-11A45- (or F) 120	700HB32A1-1-4		
788BXM4L-240A	KUP-11A45- (or F) 240	700HB32A2-1-4L		
788BXM4L-12D	KUP-11D45- (or F) 12	700HB32Z12-1-4		
788BXM4L-24D	KUP-11D45- (or F) 24	700HB32Z24-1-4		
788BXM4L-110D	KUP-11D45- (or F) 110	700HB32Z1-1-4		
788CXM4L-24A	KUP-14A45- (or F) 24	700HB33A24-1-4		
788CXM4L-120A	KUP-14A45- (or F) 120	700HB33A1-1-4		
788CXM4L-240A	KUP-14A45- (or F) 240	700HB33A2-1-4L		
788CXM4L-12D	KUP-14D45- (or F) 12	700HB33Z12-1-4		
788CXM4L-24D	KUP-14D45- (or F) 24	700HB33Z24-1-4		
788CXM4L-110D	KUP-14D45- (or F) 110	700HB33Z1-1-4		

THE CROSS REFERENCE IS INTENDED TO MATCH FOOT PRINT, INTERNAL WIRING, AND CONTACT LOAD RATINGS. CONSTRUCTION FEATURES AND GENERAL SPECIFICATIONS SHOULD BE COMPARED IF EXACT REPLACEMENT IS REQUIRED.



# SECTION 1 CROSS REFERENCE GUIDE

MAGNECRAFT & STRUTHERS-DUNN	TYCO / POTTER & BRUMFIELD	IDEC	OMRON	DELTROL
A283XAXC-24A	KUP5A15 (or F) - 24	RR1BA-U-AC24V	MJN1C-AC24	20306-82
A283XAXC-120A	KUP5A15 (or F) - 120	RR1BA-U-AC120V	MJN1C-AC120	20306-84
A283XAXC-240A	KUP5A15 (or F) - 240	RR1BA-U-AC240V	MJN1C-AC240	20306-85
A283XBXC-24A	KUP11A15 (or F) - 24	RR2BA-U-AC24V	MJN2C-AC24	20307-82
A283XBXC-120A	KUP11A15 (or F) - 120	RR2BA-U-AC120V	MJN2C-AC120	20307-84
A283XBXC-240A	KUP11A15 (or F) - 240	RR2BA-U-AC240V	MJN2C-AC240	20307-85
A283XCXC-24A	KUP14A15 (or F) - 24	RR3B-U-AC24V	MJN3C-AC24	20308-82
A283XCXC-120A	KUP14A15 (or F) - 120	RR3B-U-AC120V	MJN3C-AC120	20308-84
A283XCXC-240A	KUP14A15 (or F) - 240	RR3B-U-AC240V	MJN3C-AC240	20308-85
A283XAXC-12D	KUP5D15 (or F) - 12	RR1BA-U-DC12V	MJN1C-DC12	20309-81
A283XAXC-24D	KUP5D15 (or F) - 24	RR1BA-U-DC24V	MJN1C-DC24	20309-82
A283XBXC-12D	KUP11D15 (or F) - 12	RR2BA-U-DC12V	MJN2C-DC12	20310-81
A283XBXC-24D	KUP11D15 (or F) - 24	RR2BA-U-DC24V	MJN2C-DC24	20310-82
A283XBXC-110D	KUP11D15 (or F) - 110	RR2B-U-DC110V	MJN2C-DC110	20310-84
A283XCXC-12D	KUP14D15 (or F) - 12	RR3B-U-DC12V	MJN3C-DC12	20311-81
A283XCXC-24D	KUP14D15 (or F) - 24	RR3B-U-DC24V	MJN3C-DC24	20311-82
A283XAXC1-120A	KUP5A55 (or F) - 120	RR1BA-US-AC120V	MJN1CF-AC120	20545-84
A283XAXC1-240A	KUP5A55 (or F) - 240	RR1BA-US-AC240V	MJN1CF-AC240	20545-85
A283XBXC1-120A	KUP11A55 (or F) - 120	RR2BA-US-AC120V	MJN2CF-AC120	20546-84
A283XBXC1-240A	KUP11A55 (or F) - 240	RR2BA-US-AC240V	MJN2CF-AC240	20546-85
A283XCXC1-120A	KUP14A55 (or F) - 120	RR3B-US-AC120V	MJN3CF-AC120	20547-84
A283XCXC1-240A	KUP14A55 (or F) - 240	RR1BA-US-DC240V	MJN3CF-AC240	20547-85
A283XAXC1-12D	KUP5D55 (or F) - 12	RR1BA-US-DC12V	MJN1CF-DC12	20551-81
A283XAXC1-24D	KUP11D55 (or F) - 24	RR2BA-US-DC24V	MJN1CF-DC24	20551-82
A283XBXC1-12D	KUP11D55 (or F) - 12	RR2BA-US-DC12V	MJN2CF-DC12	20552-81
A283XBXC1-24D	KUP11D55 (or F) - 24	RR2B-US-DC24V	MJN2CF-DC24	20552-82
A283XCXC1-24D	KUP14D55 (or F) - 24	RR3B-US-DC24V	MJN3CF-DC24	20553-82
A283XB69C-120A	KUEP-11A15-120			
A283XB69C-12D	KUEP-11D15-12			
A283XB69C-24D	KUEP-11D15-24			
A283BXX69C-24D	KUEP-7D15-24			
A283BXX69C-48D	KUEP-7D15-48			
A283XB69C-110D	KUEP-11D15-110			
A283HXX69C-120A	KUEP-3A15-120			
A283HXX69C-12D	KUEP-3D15-12			
A283HXX69C-24D	KUEP-3D15-24			
A283HXX69C-48D	KUEP-3D15-48			
A283HXX69C-110D	KUEP-3D15-110			
MAGNECRAFT & STRUTHERS-DUNN	TYCO / POTTER & BRUMFIELD	TYCO / SCHRACK	FINDER	
388JXCXC1M-240A	KUMP-14A68-240	RM333740		
388JXCXC1M-120A	KUMP-14A68-120	RM333615		
388JXCXC1M-12D	KUMP-14D68-12	RM333012		
388JXCXC1M-24D	KUMP-14D68-24	RM333024		
388JXCXCM-240A	KUMP-14A28-240	RM332740	6233 8240 0040	
388JXCXCM-120A	KUMP-14A28-120	RM332615	6233 8120 0040	
388JXCXCM-12D	KUMP-14D28-12	RM332012	6233 9012 0040	
388JXCXCM-24D	KUMP-14D28-24	RM332024	6233 9024 0040	

THE CROSS REFERENCE IS INTENDED TO MATCH FOOT PRINT, INTERNAL WIRING, AND CONTACT LOAD RATINGS. CONSTRUCTION FEATURES AND GENERAL SPECIFICATIONS SHOULD BE COMPARED IF EXACT REPLACEMENT IS REQUIRED.



# SECTION 1 CROSS REFERENCE GUIDE

MAGNECRAFT & STRUTHERS-DUNN	TYCO / POTTER & BRUMFIELD	TYCO / SCHRACK	FINDER
388JXBXC1M-240A	KUMP-11A68-240	RM233740	
388JXBXC1M-120A	KUMP-11A68-120	RM233615	
388JXBXC1M-12D	KUMP-11D68-12	RM233012	
388JXBXC1M-24D	KUMP-11D68-24	RM233024	
388JXBXC1M-240A	KUMP-11A28-240	RM232740	6232 8240 0040
388JXBXC1M-120A	KUMP-11A28-120	RM232615	6232 8120 0040
388JXBXC1M-12D	KUMP-11D28-12	RM232012	6232 9012 0040
388JXBXC1M-24D	KUMP-11D28-24	RM232024	6232 9024 0040
MAGNECRAFT & STRUTHERS-DUNN	TYCO / POTTER & BRUMFIELD	TYCO / SCHRACK	FINDER
388VCXXCM-220/240A	KUGP-12A15-240	RM632740	62.33 8240.0310
388VCXXCM-120A	KUGP-12A15-120	RM632615	62.33 8120.0310
388VCXXCM-24A	KUGP-12A15-24	RM632524	62.32 8024.0310
388VBXXCM-220/240A	KUGP-7A15-240	RM532740	62.22 8240.0310
388VBXXCM-120A	KUGP-7A15-120	RM532615	62.23 8120.0310
388VBXXCM-24A	KUGP-7A15-24	RM532524	62.23 8024.0310
388VCXXCM-24D	KUGP-12D15-24	RM632024	62.32 9024.0310
388VCXXCM-12D	KUGP-12D15-12	RM632012	62.32 9012.0310
388VBXXCM-24D	KUGP-7D15-24	RM532024	62.32 9024.0310
388VBXXCM-12D	KUGP-7D15-12	RM532012	62.33 9012.0310
MAGNECRAFT & STRUTHERS-DUNN		TYCO / SCHRACK	FINDER
389FXCXC1M-240A		RM735740	6283 8240 0040
389FXCXC1M-120A		RM735615	6283 8120 0040
389FXBXC1M-240A		RM835740	6282 8240 0040
389FXBXC1M-120A		RM83561	6282 8240 0040
389FXCXC1M-12D		RM735024	6283 9024 0040
389FXCXC1M-24D		RM735012	6283 9012 0040
389FXBXC1M-12D		RM835024	6282 9024 0040
389FXBXC1M-24D		RM835012	6282 9012 0040
MAGNECRAFT & STRUTHERS-DUNN	TYCO / POTTER & BRUMFIELD	TYCO / SCHRACK	DELTROL
W389ADCX-4	KUMP-3A5G-120	RMD 05 615	0840-84
W389ADCX-5	KUMP-3A5G-240	RMD 05 740	20840-85
W389ADZCX-3	KUMP-6A5G-24	RMC 05 524	
W389ADZCX-4	KUMP-6A5G-120	RMC 05 615	
W389DCX-2	KUMP-3D5G-12	RMD 05 012	20848-81
W389DCX-3	KUMP-3D5G-24	RMD 05 024	20848-82
W389DZCX-2	KUMP-6D5G-12	RMC 05 012	
W389DZCX-3	KUMP-6D5G-24	RMC 05 024	
W389ACX-4	KUHP-5A51-120		
W389ACX-8	KUHP11A51-24		
W389ACX-9	KUHP11A51-120		
W389ACX-10	KUHP11A51-240		
W389ACX-14	-		
W389ACX-15	-		
W389CX-2	KUHP5D51-12		
W389CX-3	KUHP5D51-24		

THE CROSS REFERENCE IS INTENDED TO MATCH FOOT PRINT, INTERNAL WIRING, AND CONTACT LOAD RATINGS. CONSTRUCTION FEATURES AND GENERAL SPECIFICATIONS SHOULD BE COMPARED IF EXACT REPLACEMENT IS REQUIRED.



# SECTION 1 CROSS REFERENCE GUIDE

MAGNECRAFT & STRUTHERS-DUNN	TYCO / POTTER & BRUMFIELD			
W389CX-7				
W389CX-8				
W389CX-12				
W389CX-13				
MAGNECRAFT & STRUTHERS-DUNN	DELTRON			
300XBXC1-240A	20844-85			
300XBXC1-120A	20844-84			
300XBXC1-24A	20844-82			
300XBXC1-12A	20844-81			
300XBXC1-110D	20852-84			
300XBXC1-24D	20852-82			
300XBXC1-12D	20852-81			
MAGNECRAFT & STRUTHERS-DUNN	TYCO / POTTER & BRUMFIELD	AMERICAN ZETTLER		
W9AS1D52-5	T9AS1D52-5	AZ2280-1A-5DEF		
W9AS1D52-12	T9AS1D52-12	AZ2280-1A-12DEF		
W9AS1D52-24	T9AS1D52-24	AZ2280-1A-24DEF		
W9AS1D52-48	T9AS1D52-48	AZ2280-1A-48DEF		
W9AS1D52-110	T9AS1D52-110	AZ2280-1A-110DEF		
W9AS5D52-5	T9AS5D52-5	AZ2280-1C-5DEF		
W9AS5D52-12	T9AS5D52-12	AZ2280-1C-12DEF		
W9AS5D52-24	T9AS5D52-24	AZ2280-1C-24DEF		
W9AS5D52-48	T9AS5D52-48	AZ2280-1C-48DEF		
W9AS5D52-110	T9AS5D52-110	AZ2280-1C-110DEF		
W9AS1A52-24		AZ2280-1A-24AEF		
W9AS1A52-120		AZ2280-1A-120AEF		
W9AS1A52-240		AZ2280-1A-240AEF		
W9AS5A52-24		AZ2280-1C-24AEF		
W9AS5A52-120		AZ2280-1C-120AEF		
W9AS5A52-240		AZ2280-1C-240AEF		
MAGNECRAFT & STRUTHERS-DUNN	TYCO / POTTER & BRUMFIELD	AMERICAN ZETTLER	OMRON	AROMAT
W92S7D22-12	T92P7D22-12	AZ2800-2A-12D	G7L-2A-TUB-CB-DC24	HE2aN-Q-DC24V
W92S7D22-24	T92P7D22-24	AZ2800-2A-24D	G7L-2A-TUB-CB-DC110	HE2aN-Q-DC110V
W92S7D22-110	T92P7D22-110	AZ2800-2A-110D		
W92S11D22-12	T92P11D22-12	AZ2800-2C-12D		
W92S11D22-24	T92P11D22-24	AZ2800-2C-24D		
W92S11D22-110	T92P11D22-110	AZ2800-2C-110D	G7L-2A-TUB-CB-AC24	HE2aN-Q-AC24V
W92S7A22-24	T92P7A22-24	AZ2800-2A-24AE	G7L-2A-TUB-CB-AC120	HE2aN-Q-AC120V
W92S7A22-120	T92P7A22-120	AZ2800-2A-120AE	G7L-2A-TUB-CB-AC240	HE2aN-Q-AC240V
W92S7A22-240	T92P7A22-240	AZ2800-2A-240AE		
W92S11A22-24	T92P11A22-24	AZ2800-2C-24AE		
W92S11A22-120	T92P11A22-120	AZ2800-2C-120AE		
W92S11A22-240	T92P11A22-240	AZ2800-2C-240AE		
MAGNECRAFT & STRUTHERS-DUNN	TYCO / POTTER & BRUMFIELD			
W67RCSX-1	R10E1(X or Y)2-V28			
W67RCSX-2	R10E1(X or Y)2-V185			

THE CROSS REFERENCE IS INTENDED TO MATCH FOOT PRINT, INTERNAL WIRING, AND CONTACT LOAD RATINGS. CONSTRUCTION FEATURES AND GENERAL SPECIFICATIONS SHOULD BE COMPARED IF EXACT REPLACEMENT IS REQUIRED.



# SECTION 1 CROSS REFERENCE GUIDE

MAGNECRAFT & STRUTHERS-DUNN	TYCO / POTTER & BRUMFIELD
W67RCSX-3	R10E1(X or Y)2-V700
W67RCSX-4	R10E1(X or Y)2-V2.5K
W67RCSX-5	R10E1(X or Y)2-V15.0K
W67RCSX-6	R10E1(X or Y)4-V28
W67RCSX-7	R10E1(X or Y)4-V185
W67RCSX-8	R10E1(X or Y)4-V700
W67RCSX-9	R10E1(X or Y)4-V2.5K
W67RCSX-10	R10E1(X or Y)4-V15.0K
W67RCSX-12	R10E1(X or Y)6-V90
W67RCSX-13	R10E1(X or Y)6-V430
W67TRCSX-2	R10E1(P or Z)2-V185
W67TRCSX-3	R10E1(P or Z)2-V700
W67TRCSX-7	R10E1(P or Z)4-V185
W67TRCSX-8	R10E1(P or Z)4-V700
W67TRCSX-12	R10E1(P or Z)6-V90
W67TRCSX-13	R10E1(P or Z)6-V430
W67RPCX-2	R10E2(X or Y)2-V185
W67RPCX-3	R10E2(X or Y)2-V700
W67RPCX-7	R10E2(X or Y)4-V185
W67RPCX-8	R10E2(X or Y)4-V700
W67RPCX-12	R10E2(X or Y)6-V90
W67RPCX-13	R10E2(X or Y)6-V430
W67ARCSX-5	R10E1(X or Y)2-120V
W67ARCSX-10	R10E1(X or Y)4-120V
W67ARCSX-15	R10E1(X or Y)6-120V
W67SCSX-1	R10SE1(X or Y)2-J1.0K
W67SCSX-2	R10SE1(X or Y)2-J2.5K
W67SCSX-3	R10SE1(X or Y)2-J5.0K
W67SCSX-6	R10SE1(X or Y)4-J1.0K
W67SCSX-7	R10SE1(X or Y)4-J2.5K
W67SCSX-8	R10SE1(X or Y)4-J5.0K
MAGNECRAFT & STRUTHERS-DUNN	TYCO / POTTER & BRUMFIELD
750XBXH-12A	KR11AGE (or GF) 12
750XBXH-24A	KR11AGE (or GF) 24
750XBXH-120A	KR11AGE (or GF) 120
750XBXH-12D	KR11DGE (or GF) 12
750XBXH-24D	KR11DGE (or GF) 24
750XBXH-110D	KR11DGE (or GF) 110
750XCXH-12A	KR14AGE (or GF) 12
750XCXH-24A	KR14AGE (or GF) 24
750XCXH-120A	KR14AGE (or GF) 120
750XCXH-12D	KR14DGE (or GF) 12
750XCXH-24D	KR14DGE (or GF) 24
750XCXH-110D	KR14DGE (or GF) 110
MAGNECRAFT & STRUTHERS-DUNN	MIDTEX
W21ACPX-2	136-62T3A1

## U. S. A.

TELEPHONE: (843)393-5778  
FAX: (843)393-4123  
WEBSITE: [www.magnecraft.com](http://www.magnecraft.com)  
EMAIL: [info@magnecraft.com](mailto:info@magnecraft.com)

## EUROPE

TELEPHONE: 4989 / 75080310  
FAX: 4989 / 7559344  
WEBSITE: [www.magnecraft.com](http://www.magnecraft.com)  
EMAIL: [renatesteinback@magnecraft.de](mailto:renatesteinback@magnecraft.de)

**FOR SOCKET COMPATIBLE AND FLANGE MOUNTED RELAYS APPLICATION ENGINEERING ASSISTANCE**

*Chuck Johnson*, PRODUCT MANAGER

FAX: (847) 441-2522  
EMAIL: [cjohnson@magnecraft.com](mailto:cjohnson@magnecraft.com)

*Tom Mahaffey*, PRODUCT MANAGER

FAX: (843) 395-8530  
EMAIL: [tmahaffey@magnecraft.com](mailto:tmahaffey@magnecraft.com)  
FAX ON DEMAND: 1-800-891-2957  
DOCUMENT: 500



THE CROSS REFERENCE IS INTENDED TO MATCH FOOT PRINT, INTERNAL WIRING, AND CONTACT LOAD RATINGS. CONSTRUCTION FEATURES AND GENERAL SPECIFICATIONS SHOULD BE COMPARED IF EXACT REPLACEMENT IS REQUIRED.