

42 mm sq. (1.65 inch sq.)

1.8° /step RoHS

Bipolar winding, Lead wire type
Unipolar winding, Connector type ▶ p. 61

Customizing

- Hollow Shaft modification
- Decelerator Encoder
- Brake

Varies depending on the model number and quantity. Contact us for details.

Bipolar winding, Lead wire type

Model number		Holding torque at 2-phase energization	Rated current	Wiring resistance	Winding inductance	Rotor inertia	Mass (Weight)	Motor length (L)
Single shaft	Dual shaft	[N·m (oz·in) min.]	A/phase	Ω /phase	mH/phase	[× 10 ⁻⁴ kg·m ² (oz·in ²)]	[kg (lbs)]	mm (in)
103H5205-5040	103H5205-5010	0.23 (32.57)	0.25	54	78	0.036 (0.20)	0.23 (0.51)	33 (1.25)
103H5205-5140	103H5205-5110	0.25 (35.40)	0.5	13.4	23.4	0.036 (0.20)	0.23 (0.51)	33 (1.25)
103H5205-5240	103H5205-5210	0.265 (37.53)	1	3.4	6.5	0.036 (0.20)	0.23 (0.51)	33 (1.25)
103H5208-5040	103H5208-5010	0.35 (49.56)	0.25	66	116	0.056 (0.31)	0.29 (0.64)	39 (1.54)
103H5208-5140	103H5208-5110	0.38 (53.81)	0.5	16.5	34	0.056 (0.31)	0.29 (0.64)	39 (1.54)
103H5208-5240	103H5208-5210	0.39 (55.23)	1	4.1	9.5	0.056 (0.31)	0.29 (0.64)	39 (1.54)
103H5209-5040	103H5209-5010	0.38 (53.81)	0.25	71.4	133	0.062 (0.34)	0.31 (0.68)	41 (1.61)
103H5209-5140	103H5209-5110	0.41 (58.06)	0.5	18.2	39	0.062 (0.34)	0.31 (0.68)	41 (1.61)
103H5209-5240	103H5209-5210	0.425 (60.18)	1	4.4	11	0.062 (0.34)	0.31 (0.68)	41 (1.61)
103H5210-5040	103H5210-5010	0.465 (65.85)	0.25	80	123.3	0.074 (0.40)	0.37 (0.82)	48 (1.89)
103H5210-5140	103H5210-5110	0.49 (69.39)	0.5	20	35	0.074 (0.40)	0.37 (0.82)	48 (1.89)
103H5210-5240	103H5210-5210	0.51 (72.22)	1	4.8	9.5	0.074 (0.40)	0.37 (0.82)	48 (1.89)

Characteristics diagram

103H5205-5040 103H5205-5010

Constant current circuit
Source voltage: 24 VDC
Operating current:
0.25 A/phase, 2-phase
energization (full-step)
 $J_L=[0.94 \times 10^{-4} \text{kg}\cdot\text{m}^2$ (5.14
oz·in²) use the rubber
coupling]
fs: Maximum self-start
frequency when not
loaded

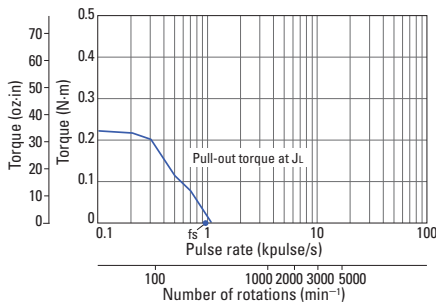

103H5205-5140 103H5205-5110

Constant current circuit
Source voltage: 24 VDC
Operating current:
0.5 A/phase, 2-phase
energization (full-step)
 $J_L=[0.94 \times 10^{-4} \text{kg}\cdot\text{m}^2$ (5.14
oz·in²) use the rubber
coupling]
fs: Maximum self-start
frequency when not
loaded

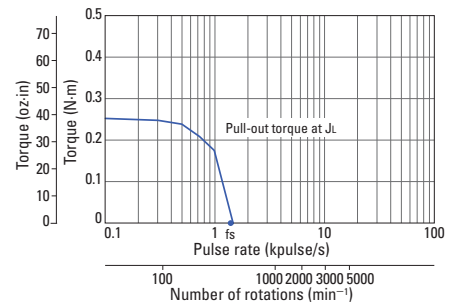

103H5205-5240 103H5205-5210

Constant current circuit
Source voltage: 24 VDC
Operating current:
1 A/phase, 2-phase
energization (full-step)
 $J_L=[0.94 \times 10^{-4} \text{kg}\cdot\text{m}^2$ (5.14
oz·in²) use the rubber
coupling]
fs: Maximum self-start
frequency when not
loaded

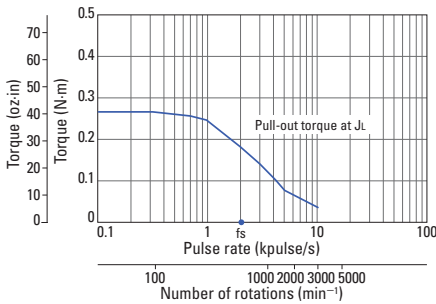

103H5208-5040 103H5208-5010

Constant current circuit
Source voltage: 24 VDC
Operating current:
0.25 A/phase, 2-phase
energization (full-step)
 $J_L=[0.94 \times 10^{-4} \text{kg}\cdot\text{m}^2$ (5.14
oz·in²) use the rubber
coupling]
fs: Maximum self-start
frequency when not
loaded

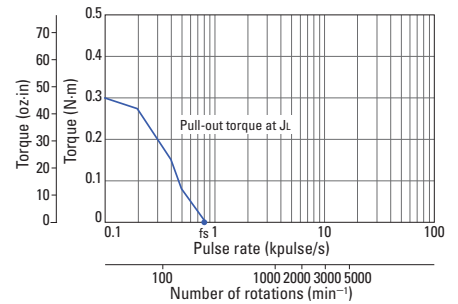

103H5208-5140 103H5208-5110

Constant current circuit
Source voltage: 24 VDC
Operating current:
0.5 A/phase, 2-phase
energization (full-step)
 $J_L=[0.94 \times 10^{-4} \text{kg}\cdot\text{m}^2$ (5.14
oz·in²) use the rubber
coupling]
fs: Maximum self-start
frequency when not
loaded

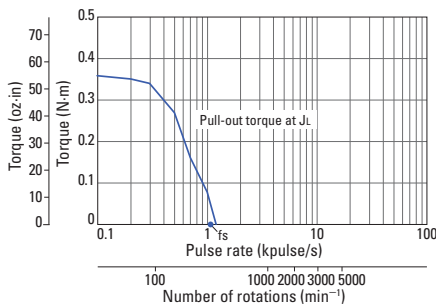

103H5208-5240 103H5208-5210

Constant current circuit
Source voltage: 24 VDC
Operating current:
1 A/phase, 2-phase
energization (full-step)
 $J_L=[0.94 \times 10^{-4} \text{kg}\cdot\text{m}^2$ (5.14
oz·in²) use the rubber
coupling]
fs: Maximum self-start
frequency when not
loaded

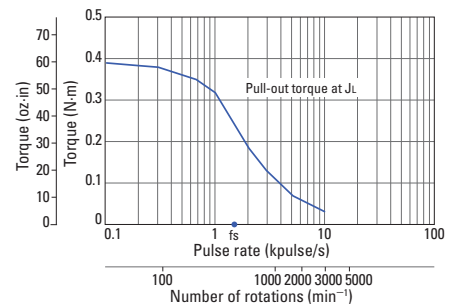

Characteristics diagram

103H5209-5040 103H5209-5010

Constant current circuit
Source voltage: 24 VDC
Operating current:
0.25 A/phase, 2-phase
energization (full-step)
 $J_L = [0.94 \times 10^{-4} \text{kg} \cdot \text{m}^2$ (5.14
oz-in²) use the rubber
coupling]
fs: Maximum self-start
frequency when not
loaded

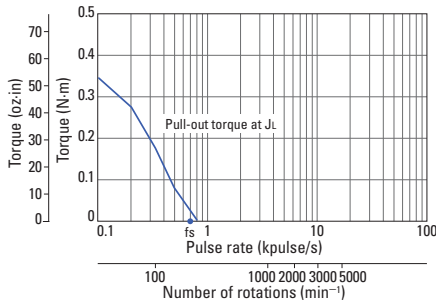

103H5209-5140 103H5209-5110

Constant current circuit
Source voltage: 24 VDC
Operating current:
0.5 A/phase, 2-phase
energization (full-step)
 $J_L = [0.94 \times 10^{-4} \text{kg} \cdot \text{m}^2$ (5.14
oz-in²) use the rubber
coupling]
fs: Maximum self-start
frequency when not
loaded

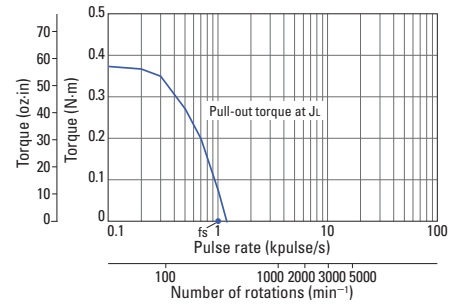

103H5209-5240 103H5209-5210

Constant current circuit
Source voltage: 24 VDC
Operating current:
1 A/phase, 2-phase
energization (full-step)
 $J_L = [0.94 \times 10^{-4} \text{kg} \cdot \text{m}^2$ (5.14
oz-in²) use the rubber
coupling]
fs: Maximum self-start
frequency when not
loaded

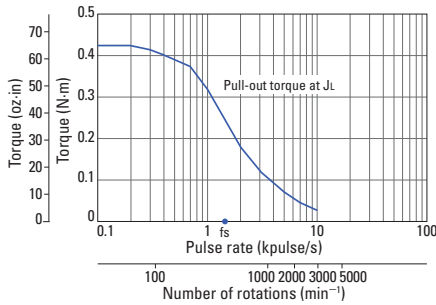

103H5210-5040 103H5210-5010

Constant current circuit
Source voltage: 24 VDC
Operating current:
0.25 A/phase, 2-phase
energization (full-step)
 $J_L = [0.94 \times 10^{-4} \text{kg} \cdot \text{m}^2$ (5.14
oz-in²) use the rubber
coupling]
fs: Maximum self-start
frequency when not
loaded

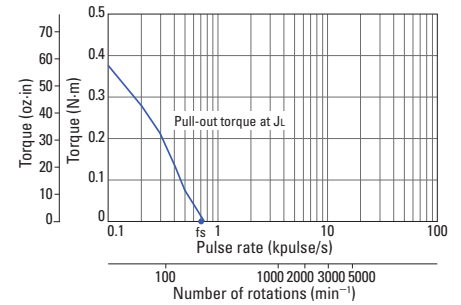

103H5210-5140 103H5210-5110

Constant current circuit
Source voltage: 24 VDC
Operating current:
0.5 A/phase, 2-phase
energization (full-step)
 $J_L = [0.94 \times 10^{-4} \text{kg} \cdot \text{m}^2$ (5.14
oz-in²) use the rubber
coupling]
fs: Maximum self-start
frequency when not
loaded

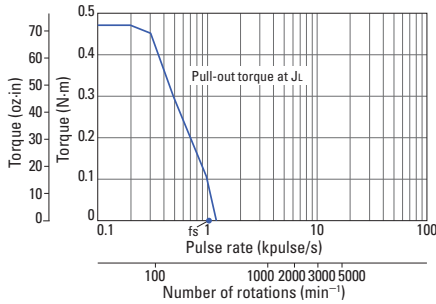

103H5210-5240 103H5210-5210

Constant current circuit
Source voltage: 24 VDC
Operating current:
1 A/phase, 2-phase
energization (full-step)
 $J_L = [0.94 \times 10^{-4} \text{kg} \cdot \text{m}^2$ (5.14
oz-in²) use the rubber
coupling]
fs: Maximum self-start
frequency when not
loaded

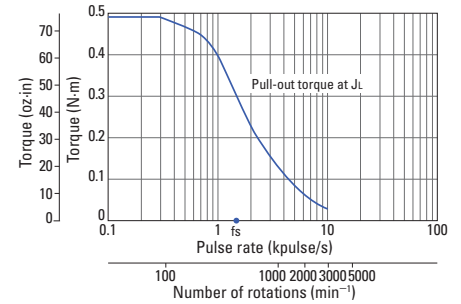

Dimensions [Unit: mm (inch)]

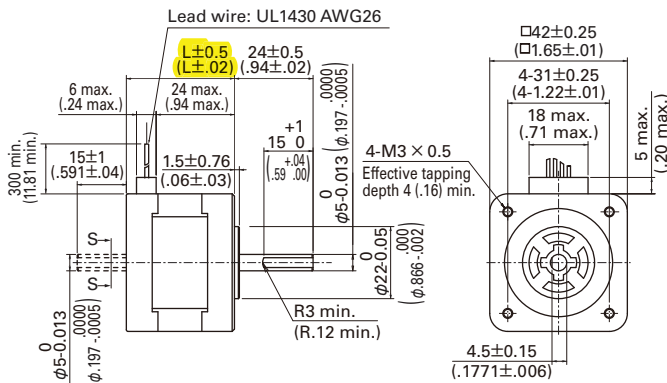

Internal wiring

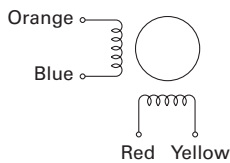

Compatible drivers

- For motor model number 103H52 □□ -50 □ 0 (0.25 A/phase), 103H52 □□ -51 □□ (0.5 A/phase)

Driver is not included.

If you require assistance finding a driver, contact us for details.

- For model number 103H52 □□ -52 □□ (1 A/phase)
Model number: BS1D200P10 (DC input)

Operating current select switch setting: A

The characteristics diagram shown above is from our experimental circuit.

Allowable Radial/Thrust Load

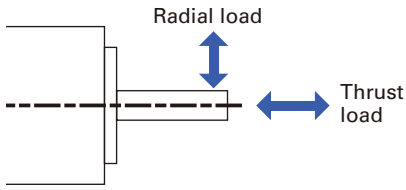

Flange size	Model number	Distance from end of shaft : mm (in)				Thrust load N (lbs)
		0	5	10	15	
Radial load : N (lbs)						
14 mm sq. (0.55 in sq.)	SH2141	10 (2.25)	11 (2.47)	13 (2.92)	-	0.7 (0.16)
28 mm sq. (1.10 in sq.)	SH228 □	42 (9)	48 (10)	56 (12)	66 (14)	3 (0.67)
35 mm sq. (1.38 in sq.)	SH353 □	40 (8)	50 (11)	67 (15)	98 (22)	10 (2.25)
42 mm sq. (1.65 in sq.)	103H52 □□	22 (4)	26 (5)	33 (7)	46 (10)	10 (2.25)
	SH142 □					
50 mm sq. (1.97 in sq.)	103H670 □	71 (15)	87 (19)	115 (25)	167 (37)	15 (3.37)
56 mm sq. (2.20 in sq.)	103H712 □	85 (19)	105 (23)	138 (31)	200 (44)	15 (3.37)
	103H7128					
60 mm sq. (2.36 in sq.)	103H782 □	70 (15)	87 (19)	114 (25)	165 (37)	20 (4.50)
	SH160 □					
86 mm sq. (3.39 in sq.)	SM286 □	167 (37)	193 (43)	229 (51)	280 (62)	60 (13.488)
	SH286 □					
86 mm sq. (3.39 in sq.)	103H822 □	191 (43)	234 (53)	301 (68)	421 (95)	60 (13.488)
φ 106 mm (φ 4.17 in)	103H8922 □	321 (72)	356 (79)	401 (90)	457 (101)	100 (22.48)

Internal Wiring and Rotation Direction

Unipolar winding

Connector type Model number: 103H52 □□

Internal wire connection

() connector pin number

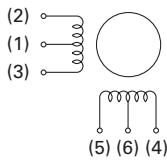

Connector type Model number: 103H782 □□

Internal wire connection

() connector pin number

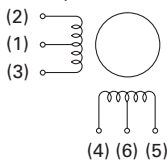

Lead wire type

Internal wire connection

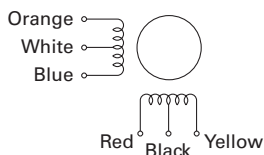

Direction of motor rotation

When excited by a direct current in the order shown below, the direction of rotation is clockwise as viewed from the output shaft side.

Exciting order	Connector pin number				
	(1.6)	(5)	(3)	(4)	(2)
1	+	-	-	-	-
2	+	-	-	-	-
3	+	-	-	-	-
4	+	-	-	-	-

Direction of motor rotation

When excited by a direct current in the order shown below, the direction of rotation is clockwise as viewed from the output shaft side.

Exciting order	Connector pin number				
	(1.6)	(4)	(3)	(5)	(2)
1	+	-	-	-	-
2	+	-	-	-	-
3	+	-	-	-	-
4	+	-	-	-	-

Direction of motor rotation

When excited by a direct current in the order shown below, the direction of rotation is clockwise as viewed from the output shaft side.

Exciting order	Lead wire color				
	White & black	Red	Blue	Yellow	Orange
1	+	-	-	-	-
2	+	-	-	-	-
3	+	-	-	-	-
4	+	-	-	-	-

Bipolar winding

Connector type

Internal wire connection

() connector pin number, terminal block number

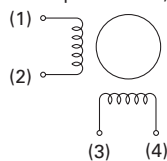

Lead wire type

Internal wire connection

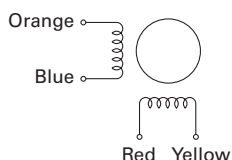

Direction of motor rotation

When excited by a direct current in the order shown below, the direction of rotation is clockwise as viewed from the output shaft side.

Exciting order	Connector pin number, terminal block number			
	(3)	(2)	(4)	(1)
1	-	-	+	+
2	+	-	-	+
3	+	+	-	-
4	-	+	+	-

Direction of motor rotation

When excited by a direct current in the order shown below, the direction of rotation is clockwise as viewed from the output shaft side.

Exciting order	Lead wire color			
	Red	Blue	Yellow	Orange
1	-	-	+	+
2	+	-	-	+
3	+	+	-	-
4	-	+	+	-

AC Input Set Models/
Drivers

DC Input Set Models/
Drivers

Stepping Motors

IP65 Splash and Dust
Proof Stepping Motors

Stepping Motors for
Vacuum Environments

Synchronous Motors

Stepping Motors with
Integrated Drivers

General Specifications

Motor model number	SH2141	SH228 <input type="checkbox"/>	SH353 <input type="checkbox"/>	SS242 <input type="checkbox"/>	SH142 <input type="checkbox"/>	103H52 <input type="checkbox"/>	SS250 <input type="checkbox"/>	103H67 <input type="checkbox"/>	103H712 <input type="checkbox"/>
Type	-								
Operating ambient temperature	- 10°C to + 50°C								
Conversation temperature	- 20°C to + 65°C								
Operating ambient humidity	20 to 90% RH (no condensation)								
Conversation humidity	5 to 95% RH (no condensation)								
Operation altitude	1000 m (3281 feet) max. above sea level								
Vibration resistance	Vibration frequency 10 to 500 Hz, total amplitude 1.52 mm (10 to 70 Hz), vibration acceleration 150 m/s ² (70 to 500 Hz), sweep time 15 min/cycle, 12 sweeps in each X, Y and Z direction.								
Impact resistance	500 m/s ² of acceleration for 11 ms with half-sine wave applying three times for X, Y, and Z axes each, 18 times in total.								
Insulation class	Class B (+130°C)								
Withstandable voltage	At normal temperature and humidity, no failure with 500 VAC @50/60 Hz applied for one minute between motor winding and frame.						At normal temperature and humidity, no failure with 1000 VAC @50/60 Hz applied for one minute between motor winding and frame.		
Insulation resistance	At normal temperature and humidity, not less than 100 MΩ between winding and frame by 500 VDC megger.								
Protection grade	IP40								
Winding temperature rise	80 K max. (Based on Sanyo Denki standard)								
Static angle error	± 0.09°				± 0.054°		± 0.09°		
Thrust play *1	0.075 mm (0.003 in) max. (load: 0.35 N (0.08 lbs))	0.075 mm (0.003 in) max. (load: 1.5 N (0.34 lbs))	0.075 mm (0.003 in) max. (load: 5 N (1.12 lbs))	0.075 mm (0.003 in) max. (load: 4 N (0.9 lbs))	0.075 mm (0.003 in) max. (load: 5 N (1.12 lbs))	0.075 mm (0.003 in) max. (load: 5 N (1.12 lbs))	0.075 mm (0.003 in) max. (load: 4 N (0.9 lbs))	0.075 mm (0.003 in) max. (load: 10 N (2.25 lbs))	0.075 mm (0.003 in) max. (load: 10 N (2.25 lbs))
Radial play *2	0.025 mm (0.001 in) max. (load: 5 N (1.12 lbs))								
Shaft runout	0.025 mm (0.001 in)								
Concentricity of mounting pilot relative to shaft	φ 0.05 mm (φ 0.002 in)	φ 0.05 mm (φ 0.002 in)	φ 0.075 mm (φ 0.003 in)	φ 0.075 mm (φ 0.003 in)	φ 0.05 mm (φ 0.002 in)	φ 0.05 mm (φ 0.002 in)	φ 0.075 mm (φ 0.003 in)	φ 0.075 mm (φ 0.003 in)	φ 0.075 mm (φ 0.003 in)
Squareness of mounting surface relative to shaft	0.1 mm (0.004 in)	0.1 mm (0.004 in)	0.1 mm (0.004 in)	0.1 mm (0.004 in)	0.1 mm (0.004 in)	0.1 mm (0.004 in)	0.1 mm (0.004 in)	0.075 mm (0.003 in)	0.075 mm (0.003 in)
Direction of motor mounting	Can be freely mounted vertically or horizontally								

Motor model number	SH160 <input type="checkbox"/>	103H78 <input type="checkbox"/>	SH286 <input type="checkbox"/>	103H8922 <input type="checkbox"/>	SM286 <input type="checkbox"/>	103H712 <input type="checkbox"/> -6 <input type="checkbox"/> 0 CE Model	103H822 <input type="checkbox"/> -6 <input type="checkbox"/> 0 CE Model	103H8922 <input type="checkbox"/> -63 <input type="checkbox"/> 1 CE Model	
Type	-				S1 (continuous operation)				
Operating ambient temperature	- 10°C to + 50°C				- 10°C to + 40°C				
Conversation temperature	- 20°C to + 65°C				- 20°C to + 60°C				
Operating ambient humidity	20 to 90% RH (no condensation)				95% max.: 40°C max., 57% max.: 50°C max., 35% max.: 60°C max. (no condensation)				
Conversation humidity	5 to 95% RH (no condensation)								
Operation altitude	1000 m (3280 feet) max. above sea level								
Vibration resistance	Vibration frequency 10 to 500 Hz, total amplitude 1.52 mm (10 to 70 Hz), vibration acceleration 150 m/s ² (70 to 500 Hz), sweep time 15 min/cycle, 12 sweeps in each X, Y and Z direction.								
Impact resistance	500 m/s ² of acceleration for 11 ms with half-sine wave applying three times for X, Y and Z axes each, 18 times in total.								
Insulation class	Class B (+130°C)				Class F (+155°C)		Class B (+130°C)		
Withstandable voltage	At normal temperature and humidity, no failure with 1000 VAC @50/60 Hz applied for one minute between motor winding and frame.				At normal temperature and humidity, no failure with 1500 VAC @50/60 Hz applied for one minute between motor winding and frame.				
Insulation resistance	At normal temperature and humidity, not less than 100 MΩ between winding and frame by 500 VDC megger.								
Protection grade	IP40				IP43				
Winding temperature rise	80 K max. (Based on Sanyo Denki standard)								
Static angle error	± 0.054°		± 0.09°						
Thrust play *1	0.075 mm (0.003 in) max. (load: 10 N (2.25 lbs))								
Radial play *2	0.025 mm (0.001 in) (load: 5 N (1.12 lbs))	0.025 mm (0.001 in) (load: 5 N (1.12 lbs))	0.025 mm (0.001 in) (load: 5 N (1.12 lbs))	0.025 mm (0.001 in) (load: 10 N (2.25 lbs))	0.025 mm (0.001 in) (load: 5 N (1.12 lbs))	0.025 mm (0.001 in) (load: 5 N (1.12 lbs))	0.025 mm (0.001 in) (load: 5 N (1.12 lbs))	0.025 mm (0.001 in) (load: 10 N (2.25 lbs))	0.025 mm (0.001 in) (load: 10 N (2.25 lbs))
Shaft runout	0.025 mm (0.001 in)								
Concentricity of mounting pilot relative to shaft	φ 0.075 mm (φ 0.003 in)								
Squareness of mounting surface relative to shaft	0.1 mm (0.004 in)	0.075 mm (0.003 in)	0.15 mm (0.006 in)	0.1 mm (0.004 in)	0.15 mm (0.006 in)	0.075 mm (0.003 in)	0.1 mm (0.004 in)	0.1 mm (0.004 in)	0.1 mm (0.004 in)
Direction of motor mounting	Can be freely mounted vertically or horizontally								

*1 Thrust play: Shaft displacement under axial load.

*2 Radial play: Shaft displacement under radial load applied 1/3rd of the length from the end of the shaft.

Safety standards

Model Number: SM286 CE/UL marked models

CE (TÜV)	Standard category		Applicable standard
	Low-voltage directives		EN60034-1, EN60034-5
UL	Acquired standards	Applicable standard	File No.
	UL	UL1004-1, UL1004-6	E179832
	UL for Canada	CSA C22.2 No.100	

Model Number: 103H712 -6 0, 103H822 -6 0, 103H8922 -63 1 CE marked model

CE (TÜV)	Standard category		Applicable standard
	Low-voltage directives		EN60034-1, EN60034-5

LEAD WIRE: UL1430 CSA.AWG26(7/0.16)

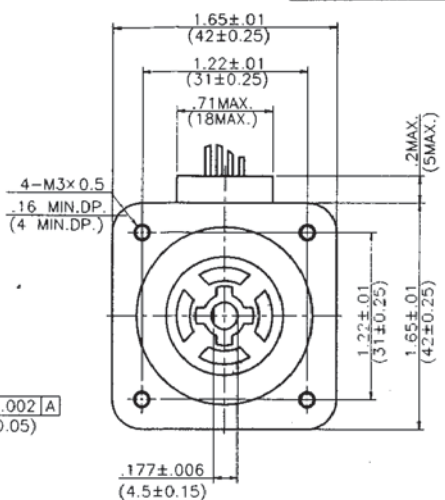
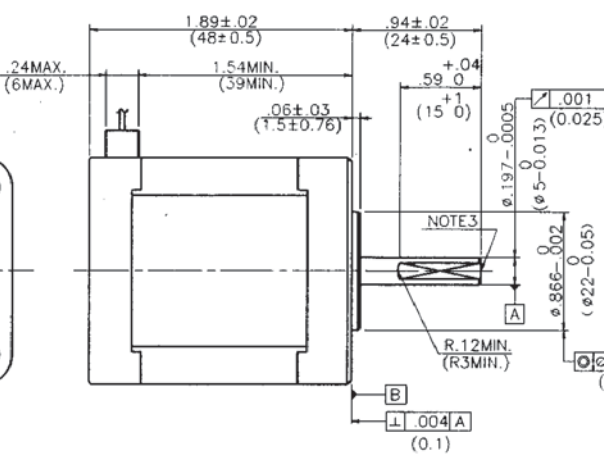
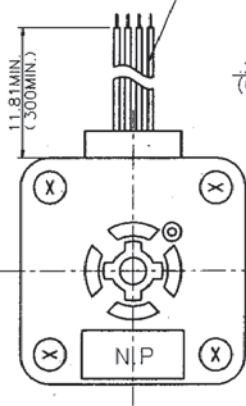

RATED CHARACTERISTICS

PHASES	2
STEP ANGLE	1.8 °
VOLTS	4.8 V(DC)
AMPS	1 A/PHASE
D.C RESISTANCE	4.8 Ω±10% at 25 °C
COIL INDUCTANCE	9.5 mH±20% at 1 kHz, 1 V(rms)
HOLDING TORQUE	72.21 oz·in (0.51 N·m) MIN. at I=1 A/PHASE 2Ex.
NOTE1. PULL OUT TORQUE	55.2 oz·in (0.39 N·m) MIN. at 200 pulse/s INERTIAL LOAD 5.14 oz·in ² (0.94×10 ⁻⁴ kg·m ²) (INCLUDE COUPLING INERTIA)
NOTE1. MAX. STARTING RATE	1200 pulse/s MIN. at NO LOAD
NOTE1. MAX. SLEWING RATE	1200 pulse/s MIN. at NO LOAD
NOTE2. POSITIONAL ACCURACY	±0.09 ° (0.18° SPREAD MAX.) 2Ex.
COIL TEMPERATURE RISE	80 K MAX.
ROTOR INERTIA	.4 oz·in ² (0.074×10 ⁻⁴ kg·m ²) NOMINAL
INSULATION CLASS	B

NOTE1. SANYO PMM-BD-4502 DRIVE CIRCUIT. (2 PHASE EXCITATION) E=24 V(DC), I=1 A/PHASE. (AVERAGE VALUE)
 NOTE2. MOUNT A MOTOR ON 4.00×4.00×.081 (100×100×2t) SPCC HEAT SINK AND ENERGIZE A COIL AT 2 PHASE EXCITATION, I=1 A/PHASE CONSTANTLY. MEASURED BY THE CHANGE OF RESISTANCE METHOD.
 NOTE3. CENTER HOLE ON THE SHAFT END IS NOT ALWAYS MADE.

CONNECTION

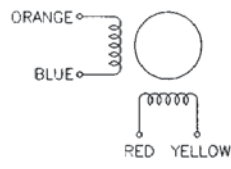

DIRECTION OF ROTATION

WHEN A MOTOR IS SEQUENCED AS SHOWN IN BELOW TABLE, THE SHAFT ROTATION MUST BE CLOCKWISE WHEN VIEWED FROM SURFACE [B] SIDE.

	RED	BLUE	YELLOW	ORANGE
STEP 1	⊕	⊖	⊕	⊕
STEP 2	⊖	⊕	⊖	⊖
STEP 3	⊕	⊖	⊕	⊖
STEP 4	⊖	⊕	⊖	⊕

E0055049		03-05-27	1/8" UNF	APPROVED BY	DATE
NEW DESIGN		02-12-25	1/16" UNF	DESIGNED BY	03-06-02
SANYO DENKI CO., LTD.				CHECKED BY	03-06-02
山洋電気株式会社				DR. ISSUED BY	03-05-27
SANYO DENKI CO., LTD.				DATE	03-05-27
103H5210-5240				STEPPING MOTOR	