



Application Tooling > Insertion & Extraction Tools



Insertion & Extraction Tool Type: **Contact Extraction**

Insertion & Extraction Tool Application: **Contact-to-Wire**

### Features

#### Product Type Features

Insertion & Extraction Tool Type	Contact Extraction
Insertion & Extraction Tool Application	Contact-to-Wire

#### Contact Features

Contact Size	AMP MCP 9.5mm
--------------	---------------

### Product Compliance

[For compliance documentation, visit the product page on TE.com>](#)

EU RoHS Directive 2011/65/EU	Not Compliant
EU ELV Directive 2000/53/EC	Out of Scope
China RoHS 2 Directive MIIT Order No 32, 2016	Restricted Materials Above Threshold
EU REACH Regulation (EC) No. 1907/2006	Current ECHA Candidate List: JUNE 2022 (224) Candidate List Declared Against: JUNE 2022 (224) SVHC > Threshold: Pb (1.03% in Component Part) <b>Article Safe Usage Statements:</b> Do not eat, drink or smoke when using this product. Wash thoroughly after handling. Recycle if possible and dispose of the article by following all applicable governmental regulations relevant to your geographic location.
Halogen Content	Low Halogen - Br, Cl, F, I < 900 ppm per homogenous material. Also BFR/CFR/PVC Free
Solder Process Capability	Not applicable for solder process capability

Product Compliance Disclaimer

This information is provided based on reasonable inquiry of our suppliers and represents our current actual knowledge based on the information they provided. This information is subject to change. The part numbers that TE has identified as EU RoHS compliant have a maximum concentration of 0.1% by weight in homogenous materials for lead, hexavalent chromium, mercury, PBB, PBDE, DBP, BBP, DEHP, DIBP, and 0.01% for cadmium, or qualify for an exemption to these limits as defined in the Annexes of Directive 2011/65/EU (RoHS2). Finished electrical and electronic equipment products will be CE marked as required by Directive 2011/65/EU. Components may not be CE marked. Additionally, the part numbers that TE has identified as EU ELV compliant have a maximum concentration of 0.1% by weight in homogenous materials for lead, hexavalent chromium, and mercury, and 0.01% for cadmium, or qualify for an exemption to these limits as defined in the Annexes of Directive 2000/53/EC (ELV). Regarding the REACH Regulation, the information TE provides on SVHC in articles for this part number is based on the latest European Chemicals Agency (ECHA) 'Guidance on requirements for substances in articles' posted at this URL: <https://echa.europa.eu/guidance-documents/guidance-on-reach>

## Compatible Parts



TE Part # CAT-T4827-T273  
TIMER, RECEPTACLE AND TAB

TE Part # 963774-2  
FASTON 9,5X1,2



TE Part # 962933-1  
MPT REC 9.5 Contact SRC Sn (LP)



TE Part # 962931-1  
MPT REC 9.5 Contact SRC Sn (LP)

TE Part # 1-1719951-6  
MPT TERMINAL

TE Part # 1-962931-6  
MAXI POWER TIMER LOOSE PIECE

TE Part # 1-962933-6  
MPT REC 9.5 Contact SRC Sn (LP)

TE Part # 1-962934-1  
MPT REC 9.5 Contact SWS Ag

TE Part # 1-962936-1  
MPT REC 9.5 Contact SWS Ag

TE Part # 1-962938-1  
MPT REC 9.5 Contact SWS Ag

TE Part # 1-963764-2  
FLACHSTECKER9,5X1,2

TE Part # 1-963766-2  
FLACHSTECKER9,5X1,2

TE Part # 1-963768-2  
TAB 9,5X1,2

TE Part # 1-963772-3  
TAB 9.5x1.2 PREFORM CS SWS Sn

TE Part # 2-962928-1  
MAXI-POWER-TIM KONT

TE Part # 2-962930-1  
MAXI-POWER-TIM KONT

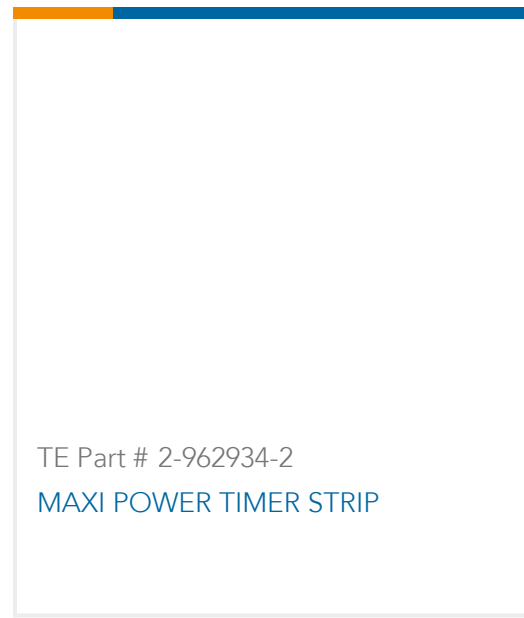

### Also in the Series | Maxi Power Timer

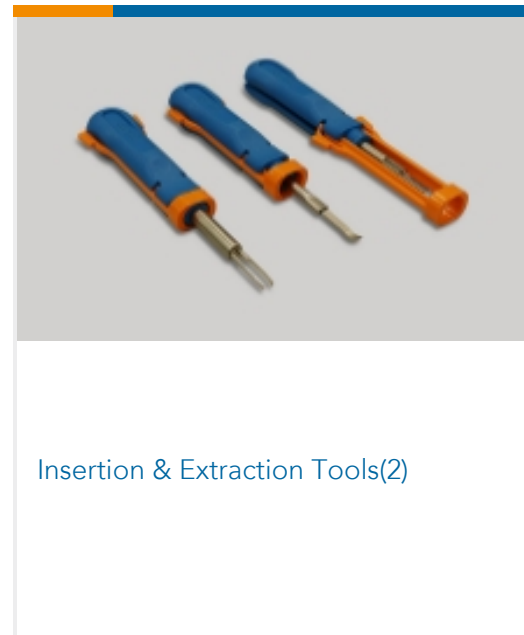
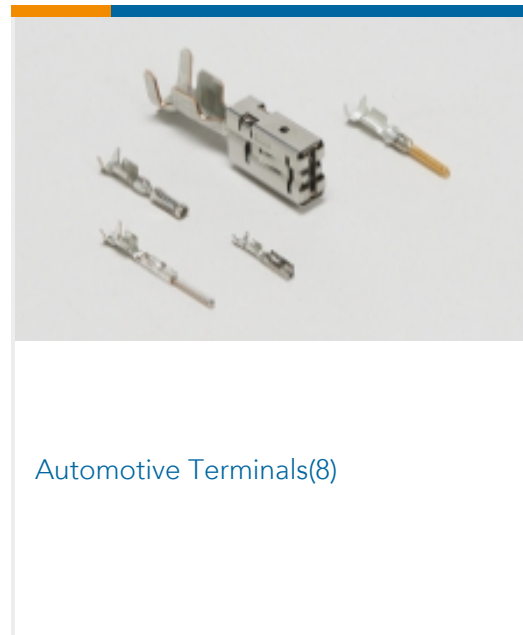
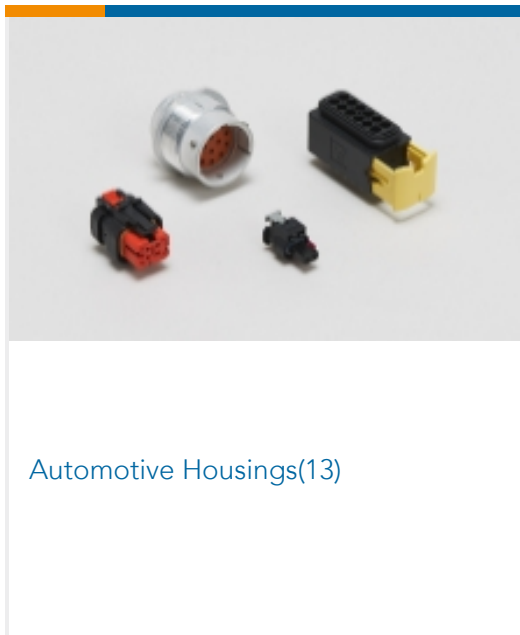

### Also in the Series | Timer Connector System

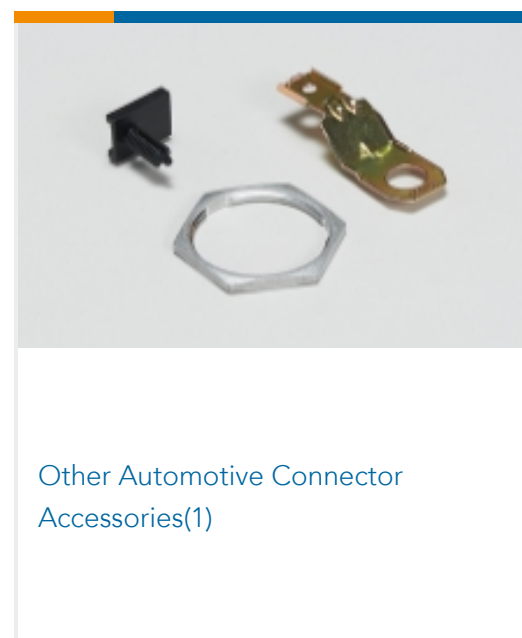
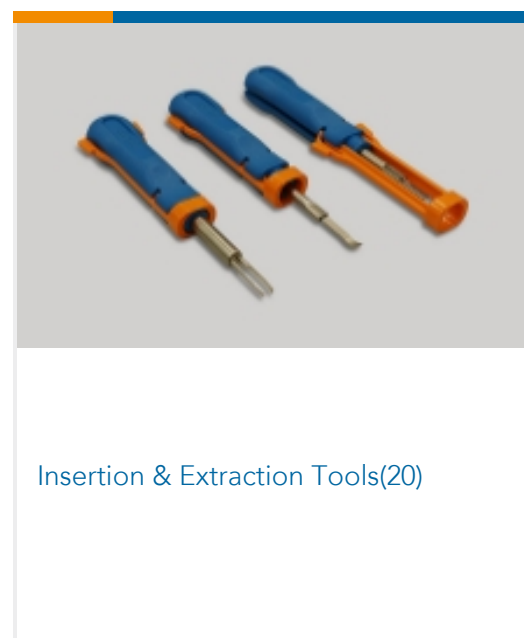
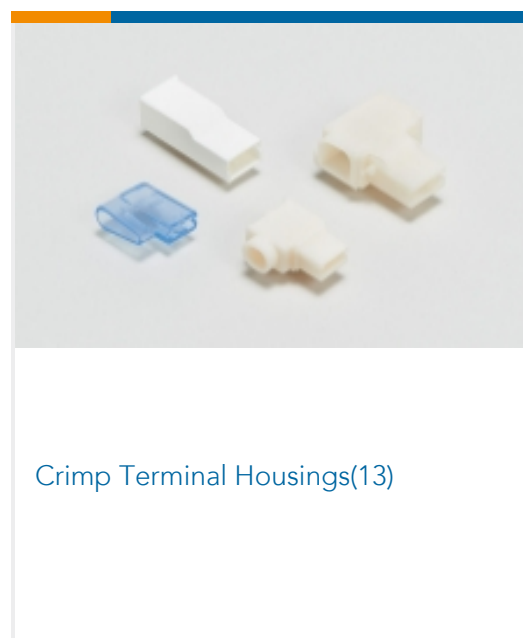
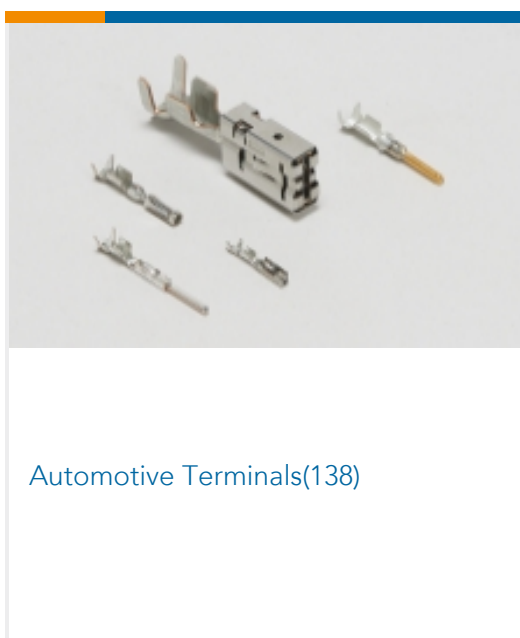
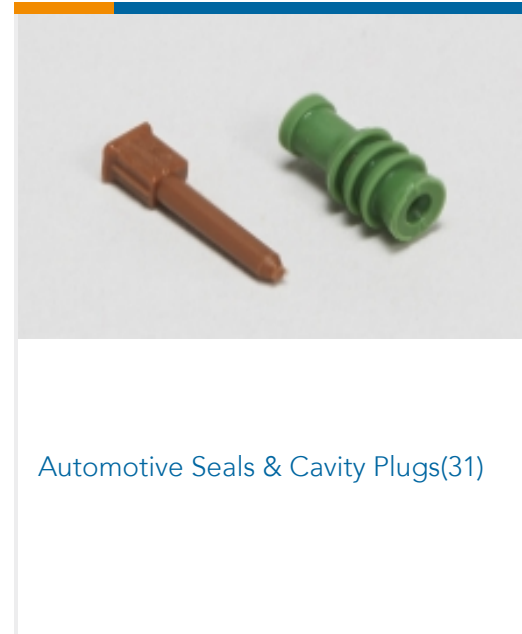
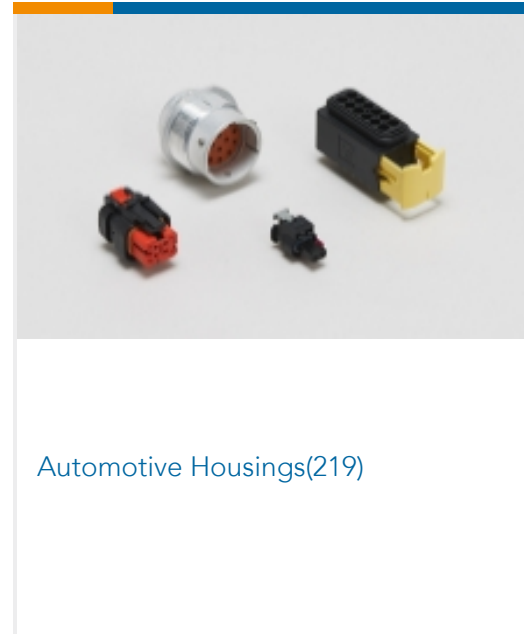
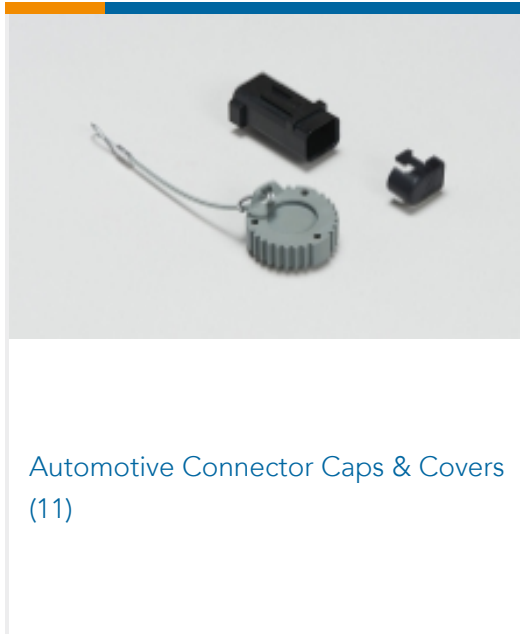



PCB Headers & Receptacles(78)



Quick Disconnects(4)

### Customers Also Bought



TE Part #1-967625-5  
JUN-POW-TIM GEH 21P



TE Part #0528-002-6005  
BKSHL, 60P, BLK, PLG, RA, NW 17



TE Part #1-1579007-3  
EXTRACTION TOOL

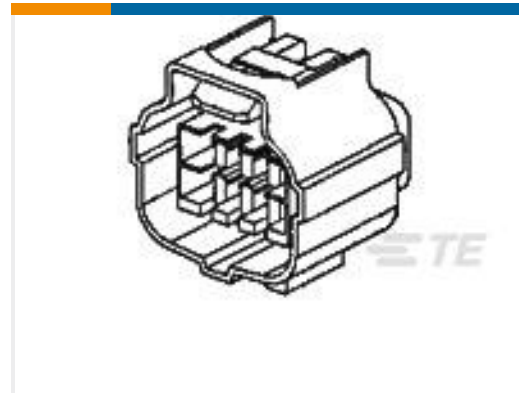

TE Part #444141-1  
KIT ECONOSEAL 10P



TE Part #282273-1  
RCPT CONN KIT



TE Part #2836360-2  
OCEAN\_2.0\_Applicator-S-200F280F

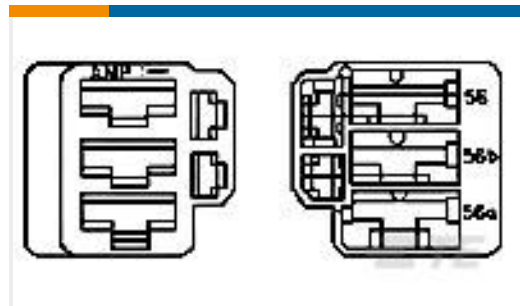

TE Part #880191-1  
5W FASTIN-ON REC. H



TE Part #0838016004  
RBK-VWS-125-NR1-X-28MM

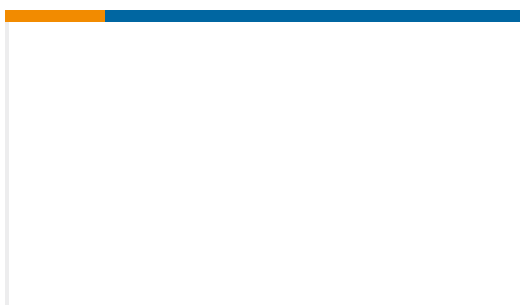

TE Part #1599562-1  
TERMINAL RING TONGUE M6



TE Part #2-571328-2  
WIRE CRIMPER

### Documents

[Product Drawings](#)  
[EXTRACTION TOOL](#)

English

[Datasheets & Catalog Pages](#)  
[AMP MCP 9.5 Two Position Connectors Series Brief](#)

English

[AMP MCP 9.5 Two Position Connectors Infographic](#)

English

