



AMP

TE Internal #: 1-1105870-8

Portable Crimp Tools, Commercial Crimp Tooling, Operator Releasable & Adjustable, Removable/Interchangeable, TE Product Specification (114-), Manual

[View on TE.com >](#)

Application Tooling > Portable Crimp Tools



Tool Grade: **Commercial Crimp Tooling**

Ratchet Configuration: **Operator Releasable & Adjustable**

Die Sets Type: **Removable/Interchangeable**

Specification Type: **TE Product Specification (114-)**

TE Certification: **Upon Request for Fee**

Features

Other

Crimp Form-Wire Barrel Type	Open Barrel - F Crimp
Tool Grade	Commercial Crimp Tooling
Ratchet Configuration	Operator Releasable & Adjustable
Die Sets Type	Removable/Interchangeable
Specification Type	TE Product Specification (114-)
TE Certification	Upon Request for Fee
Power Technology Type	Manual
Tooling Type	Ergocrimp Hand Tool Assembly or Die

Product Compliance

[For compliance documentation, visit the product page on TE.com>](#)

EU RoHS Directive 2011/65/EU	Compliant
EU ELV Directive 2000/53/EC	Out of Scope
China RoHS 2 Directive MIIT Order No 32, 2016	No Restricted Materials Above Threshold
EU REACH Regulation (EC) No. 1907/2006	Current ECHA Candidate List: JUNE 2022 (224) Candidate List Declared Against: JUL 2021 (219) SVHC > Threshold: Not Yet Reviewed













Halogen Content	Low Halogen - Br, Cl, F, I < 900 ppm per homogenous material. Also BFR/CFR/PVC Free
-----------------	---

Solder Process Capability	Not applicable for solder process capability
---------------------------	--

Product Compliance Disclaimer

This information is provided based on reasonable inquiry of our suppliers and represents our current actual knowledge based on the information they provided. This information is subject to change. The part numbers that TE has identified as EU RoHS compliant have a maximum concentration of 0.1% by weight in homogenous materials for lead, hexavalent chromium, mercury, PBB, PBDE, DBP, BBP, DEHP, DIBP, and 0.01% for cadmium, or qualify for an exemption to these limits as defined in the Annexes of Directive 2011/65/EU (RoHS2). Finished electrical and electronic equipment products will be CE marked as required by Directive 2011/65/EU. Components may not be CE marked. Additionally, the part numbers that TE has identified as EU ELV compliant have a maximum concentration of 0.1% by weight in homogenous materials for lead, hexavalent chromium, and mercury, and 0.01% for cadmium, or qualify for an exemption to these limits as defined in the Annexes of Directive 2000/53/EC (ELV). Regarding the REACH Regulation, the information TE provides on SVHC in articles for this part number is based on the latest European Chemicals Agency (ECHA) 'Guidance on requirements for substances in articles' posted at this URL: <https://echa.europa.eu/guidance-documents/guidance-on-reach>

Compatible Parts

 <p>TE Part # 1-1105251-1 HSM-C-Bu.Ag.0,75 qmm</p>	 <p>TE Part # 1-1105151-1 HSS-C-Bu.Ag.2,5 qmm</p>	 <p>TE Part # 1-1108757-1 HSK.Sti.C.1,5 qmm</p>	 <p>TE Part # 2-1105250-1 HSM-C-Sti.Ag.1,5 qmm</p>
 <p>TE Part # 2-1108756-1 HSK.Bu.C.2,5 qmm</p>	 <p>TE Part # 1-1105250-1 HSM-C-Sti.Ag.0,75 qmm</p>	 <p>TE Part # 1-1108756-1 HSK.Bu.C.1,5 qmm</p>	 <p>TE Part # 2-1105251-1 HSM-C-Bu.Ag.1,5 qmm</p>
 <p>TE Part # 3-1105250-1 HSM-C-Sti.Ag.2,5 qmm</p>	 <p>TE Part # 3-1105251-1 HSM-C-Bu.Ag.2,5 qmm</p>		

Customers Also Bought

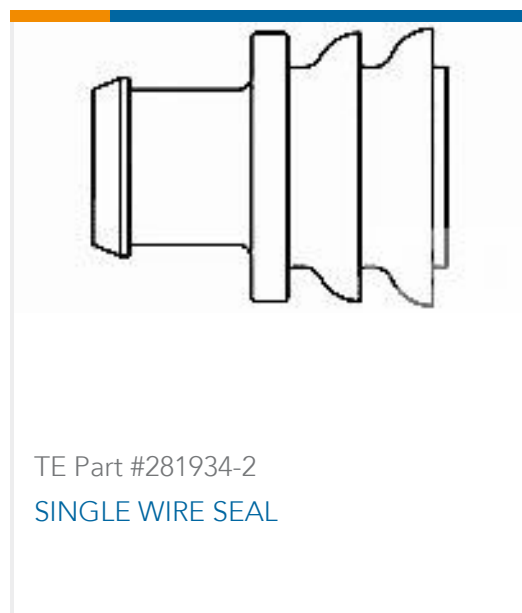

Documents

Product Drawings RSZ.LC.0,75-2,5QMM

German

Datasheets & Catalog Pages

Bottoming Dies

English