

Compact and Intelligent 1/32 DIN
Temperature Controller with
Communications Function

- Auto-tuning and self-tuning available.
Can auto-tune even during execution of self-tuning
- Various temperature inputs:
thermocouple, platinum resistance thermometer, non-contact temperature sensor, and analog inputs
- Water-resistant construction: NEMA4
(equivalent to IP66)
- Conforms to UL, CSA, IEC and CE



Ordering Information

■ E5GN STANDARD MODELS

IMPORTANT: The heating/cooling function, event input function, and heater burnout alarm are NOT available with the E5GN.

Description			Part number		
Size	Power supply voltage	No. of alarm points	Output	Thermocouple model	Platinum resistance thermometer model
1/32 DIN 48(W) x 24(H) x 100(D) mm	100 to 240 VAC	---	Relay	E5GN-RTC AC100-240	E5GN-RP AC100-240
			Voltage output (for driving SSR)	E5GN-QTC AC100-240	E5GN-QP AC100-240
		1	Relay	E5GN-R1TC AC100-240	E5GN-R1P AC100-240
			Voltage output (for driving SSR)	E5GN-Q1TC AC100-240	E5GN-Q1P AC100-240
	24 VAC/VDC	---	Relay	E5GN-RTC AC/DC24	E5GN-RP AC/DC24
			Voltage output (for driving SSR)	E5GN-QTC AC/DC24	E5GN-QP AC/DC24
1		Relay	E5GN-R1TC AC/DC24	E5GN-R1P AC/DC24	
		Voltage output (for driving SSR)	E5GN-Q1TC AC/DC24	E5GN-Q1P AC/DC24	

■ E5GN COMMUNICATION MODELS

IMPORTANT: The alarm function is NOT available with the communications models.

Description				Part number	
Size	Power supply voltage	Communication function	Output	Thermocouple model	Platinum resistance thermometer model
1/32 DIN 48(W) x 24(H) x 100(D) mm	100 to 240 VAC	RS-485	Relay	E5GN-R03TC-FLK AC100-240	E5GN-R03P-FLK AC100-240
			Voltage output (for driving SSR)	E5GN-Q03TC-FLK AC100-240	E5GN-Q03P-FLK AC100-240
	24 VAC/VDC		Relay	E5GN-R03TC-FLK AC/DC24	E5GN-R03P-FLK AC/DC24
	Voltage output (for driving SSR)		E5GN-Q03TC-FLK AC/DC24	E5GN-Q03P-FLK AC/DC24	

INPUT RANGES

Platinum Resistance Thermometer Input/Thermocouple Input

Shaded ranges indicate default settings.

		Platinum resistance thermometer input			
Input type		Platinum resistance thermometer			
Name		Pt100		JPt100	
Temperature range	1800	-	-	-	-
	1700	-	-	-	-
	1600	-	-	-	-
	1500	-	-	-	-
	1400	-	-	-	-
	1300	-	-	-	-
	1200	-	-	-	-
	1100	-	-	-	-
	1000	-	-	-	-
	900	850	-	-	-
	800	-	-	-	-
	700	-	-	-	-
	600	-	-	-	-
	500	-	500.0	-	500.0
	400	-	-	-	-
	300	-	-	-	-
	200	-	-	-	-
100	-	-	100.0	-	
0	-	-	0.0	-	
-100	-	-	-	-	
-200	-200	-199.9	-199.9	-199.9	
Set value	0	1	2	3	4

Thermocouple Input

Shaded ranges indicate default settings.

		Thermocouple input															
Input type		Thermocouple										ES1A Non-contact Temperature Sensor			Analog input		
Name		K	J		T	E	L	U	N	R	S	B	K10 to 70°C	K60 to 120°C	K115 to 165°C	K160 to 260°C	0 to 50 mV
Temperature range	1800	-	-	-	-	-	-	-	-	-	-	1800	-	-	-	-	Usable in the following ranges by scaling: -19999 to 9999 or -199.9 to 999.9
	1700	-	-	-	-	-	-	-	-	1700	1700	-	-	-	-	-	
	1600	-	-	-	-	-	-	-	-	-	-	-	-	-	-	-	
	1500	-	-	-	-	-	-	-	-	-	-	-	-	-	-	-	
	1400	-	-	-	-	-	-	-	-	-	-	-	-	-	-	-	
	1300	1300	-	-	-	-	-	-	1300	-	-	-	-	-	-	-	
	1200	-	-	-	-	-	-	-	-	-	-	-	-	-	-	-	
	1100	-	-	-	-	-	-	-	-	-	-	-	-	-	-	-	
	1000	-	-	-	-	-	-	-	-	-	-	-	-	-	-	-	
	900	-	-	850	-	-	-	-	850	-	-	-	-	-	-	-	
	800	-	-	-	-	-	-	-	-	-	-	-	-	-	-	-	
	700	-	-	-	-	-	-	-	-	-	-	-	-	-	-	-	
	600	-	-	-	-	-	600	-	-	-	-	-	-	-	-	-	
	500	-	500.0	-	-	-	-	-	-	-	-	-	-	-	-	-	
	400	-	-	400.0	400	400	-	-	400	-	-	-	-	-	-	-	
	300	-	-	-	-	-	-	-	-	-	-	-	-	-	-	-	
	200	-	-	-	-	-	-	-	-	-	-	-	-	-	-	-	
100	-	-	-	-	-	-	-	-	-	-	-	-	-	-	-		
0	-	-20.0	-100	-20.0	0	-	-	-	0	0	-	0	0	0	0		
-100	-	-	-	-	-	-	-	-	-	-	-	-	-	-	-		
-200	-200	-	-	-200	-	-100	-200	-200	-	-	-	-	-	-	-		
Set value	0	1	2	3	4	5	6	7	8	9	10	11	12	13	14	15	16

Applicable standards by input type are as follows:

- K, J, T, E, N, R, S, B: JIS C1602-1995
- L: Fe-CuNi, DIN 43710-1985
- U: Cu-CuNi, DIN 43710-1985
- JPt100: JIS C1604-1989, JIS C1606-1989
- Pt100: JIS C1604-1997, IEC751

Note: The ES1A Non-contact Temperature Sensor will be available soon.

Specifications

■ RATINGS

Supply voltage	100 to 240 VAC, 50/60 Hz	24 VAC, 50/60 Hz/24 VDC
Operating voltage range	85% to 110% of rated supply voltage	
Power consumption	7 VA	4 VA/2.5 W
Sensor input	Thermocouple: K, J, T, E, L, U, N, R, S, B Platinum resistance thermometer: Pt100, JPt100 Non-contact temperature sensor: K10 to 70°C, K60 to 120°C, K115 to 165°C, K160 to 260°C Voltage input: 0 to 50 mV	
Control output	Relay output	SPST-NO, 250 VAC, 2 A (resistive load), electrical life: 100,000 operations
	Voltage output	12 VDC (PNP), max. load current: 21 mA, with short-circuit protection
Alarm output	SPST-NO, 250 VAC, 1 A (resistive load), electrical life: 100,000 operations	
Control method	PID or ON/OFF control	
Setting method	Digital setting using front panel keys	
Indication method	7-segment digital display and single-lighting indicator	
Other functions	According to controller model	
Ambient temperature	-10°C to 55°C (14°F to 131°F) with no condensation or icing	
Ambient humidity	25% to 85% relative humidity	
Storage temperature	-25°C to 65°C (-13°F to 149°F) with no condensation or icing	

■ CHARACTERISTICS

Indication accuracy	Thermocouple: (±0.5% of indicated value or ±1°C, whichever greater) ±1 digit max. (See Note.) Platinum resistance thermometer: (±0.5% of indicated value or ±1°C, whichever greater) ±1 digit max. Analog input: ±0.5% FS±1 digit max. CT input: ±5% FS±1 digit max.
Hysteresis	0.1 to 999.9 EU (in units of 0.1 EU)
Proportional band (P)	0.1 to 999.9 EU (in units of 0.1 EU)
Integral time (I)	0 to 3999 s (in units of 1 s)
Derivative time (D)	0 to 3999 s (in units of 1 s)
Control period	1 to 99 s (in units of 1 s)
Manual reset value	0.0% to 100.0% (in units of 0.1%)
Alarm setting range	-1999 to 9999 (decimal point position depends on input type)
Sampling period	500 ms
Insulation resistance	20 MΩ min. (at 500 VDC)
Dielectric strength	2000 VAC, 50 or 60 Hz for 1 min (between different charging terminals)
Vibration resistance	10 to 55 Hz, 10 m/s ² for 2 hours each in X, Y and Z directions
Shock resistance	300 m/s ² , 3 times each in 3 axes, 6 directions (relay: 100 m/s ²)

Note: The indication of K thermocouples in the -200°C to 1300°C range, and T and N thermocouples at a temperature of -100°C or less, and U and L thermocouples at any temperature is ±2°C±1 digit maximum. The indication of B thermocouples at a temperature of 400°C or less is unrestricted.

The indication of R and S thermocouples at a temperature of 200°C or less is ±3°C±1 digit maximum.

(This table continues on the next page.)

Characteristics Table - continued from previous page

Weight	Approx. 90 g		Mounting bracket: approx. 10g
Protective structure	Front Panel	NEMA4 for indoor use (equivalent to IP66)	
	Rear Case	IP20	
	Terminals	IP00	
Memory protection	EEPROM (non-volatile memory) (number of writes: 100,000)		
EMC	Emission Enclosure:	EN55011 Group 1 class A	
	Emission AC Mains:	EN55011 Group 1 class A	
	Immunity ESD:	EN61000-4-2: 4 kV contact discharge (level 2) 8 kV air discharge (level 3)	
	Immunity RF-interference:	ENV50140: 10 V/m (amplitude modulated, 80 MHz to 1 GHz) (level 3) 10 V/m (pulse modulated, 900 MHz)	
	Immunity Conducted Disturbance:	ENV50141: 10 V (0.15 to 80 MHz) (level 3)	
	Immunity Burst:	EN61000-4-4: 2 kV power-line (level 3) 2 kV I/O signal-line (level 4)	
Approval standards	UL3121-1, CSA22.2 No. 14, E.B.1402C Conforms to EN50081-2, EN50082-2, EN61010-1 (IEC1010-1) Conforms to VDE0106/part 100 (Finger Protection), when the terminal cover is mounted.		

■ COMMUNICATIONS SPECIFICATIONS

Transmission path connection	Multiple points
Communications method	RS-485 (two-wire, half duplex)
Synchronization method	Start-stop synchronization
Baud rate	1,200/2,400/4,800/9,600/19,200 bps
Transmission code	ASCII
Data bit length	7 or 8 bits
Stop bit length	1 or 2 bits
Error detection	Vertical parity (none, even, odd) Frame check sequence (FCS): with SYSMAC WAY Block check character (BCC): with CompoWay/F
Flow control	Not available
Interface	RS-485
Retry function	Not available
Communications buffer	40 bytes

Note: The baud rate, data bit length, stop bit length, or vertical parity can be individually set using the communications setting level.

Nomenclature

■ E5GN

Operation Indicators

1. AL (alarm)
Lights when alarm output is ON.
2. CMW (communications writing control)
Lights when communications writing is enabled and is out when it is disabled.
3. STP (stop)
Lights when control of the E5GN has been stopped. During control, this indicator lights when an event or the run/stop function has been stopped, or, this indicator is out.
4. OUT (control output)
Lights when control output is ON.

Temperature Unit

The temperature unit is displayed when the display unit parameter is set to a temperature. Indication is determined by the currently selected "temperature unit" parameter set value. When this parameter is set to "°C," "C" is displayed, and when set to "°F," "F" is displayed.

No. 1 Display

Displays the process value or parameter type.

No. 2 Display

Displays the set point, manipulated variable or set value (setup) of the parameter.

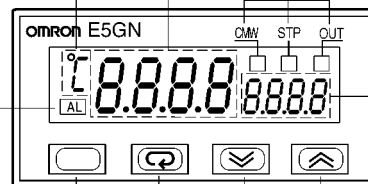

Up Key

Each press of this key increases values displayed on the No.2 display. Holding down this key continuously increases values.

Down Key

Each press of this key decreases values displayed on the No.2 display. Holding down this key continuously decreases values.

Level + Mode Key

This key combination sets the E5GN to the "protect level."

Level Key

Press this key to select the setup level. The setup level is selected in this order: "operation level" ↔ "adjustment level," "initial setting level" ↔ "communications setting level."

Mode Key

Press this key to select parameters within each level.

Dimensions

Unit: mm (inch)

■ E5GN

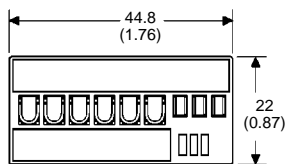
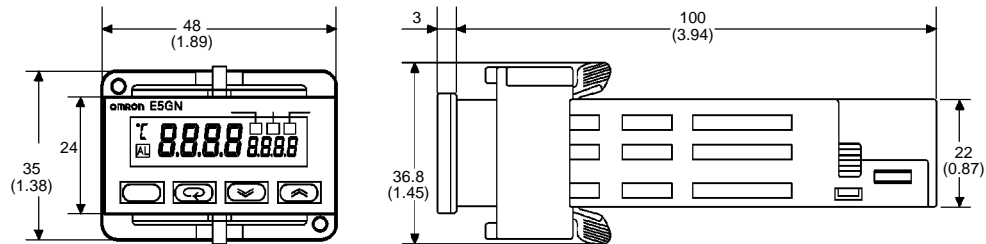

* When carrying out maintenance on the E5GN, only the terminal plate can be drawn out with the terminal leads still attached.

Panel Cutout

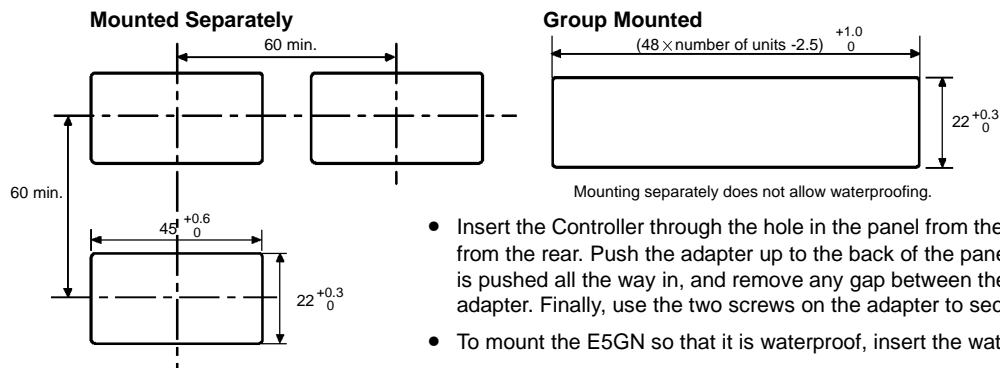

Mounting separately does not allow waterproofing.

- Insert the Controller through the hole in the panel from the front and push the adapter on from the rear. Push the adapter up to the back of the panel, ensuring that the controller is pushed all the way in, and remove any gap between the Controller, the panel, and the adapter. Finally, use the two screws on the adapter to secure the unit in place.
- To mount the E5GN so that it is waterproof, insert the waterproof seal onto the E5GN.
- When two or more E5GN Controllers are mounted, make sure that the surrounding temperature does not exceed the allowable operating temperature given in the specifications.

Installation

■ MOUNTING

1. Insert the E5GN into the mounting hole in the panel from the front.
2. Push the adapter along the E5GN body from the terminals up to the panel, and secure it temporarily.
3. Tighten the two fixing screws on the adapter. When tightening screws, tighten the two screws alternately (keeping the torque to within approximately 0.29 to 0.39 N•m).

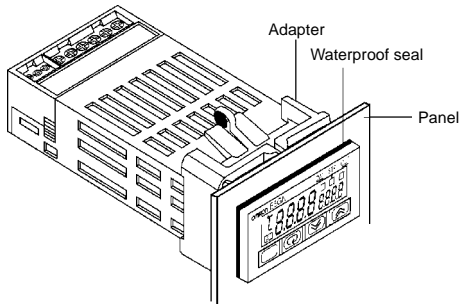

■ REMOVING AND ATTACHING THE TERMINAL PLATE

The E5GN can be replaced by removing the terminal plate.

1. Press down hard on the fasteners on both sides of the terminals to unlock the terminal plate and pull upward.

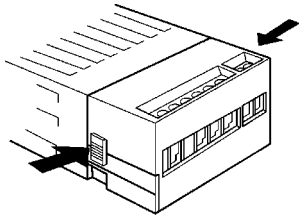

2. Pull to remove the terminal plate.

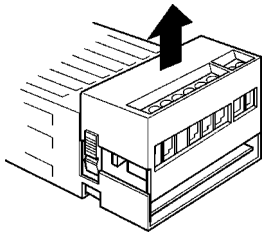

3. Before you insert the terminal plate again, make sure that the pins match the positions of the holes in the terminal plate.

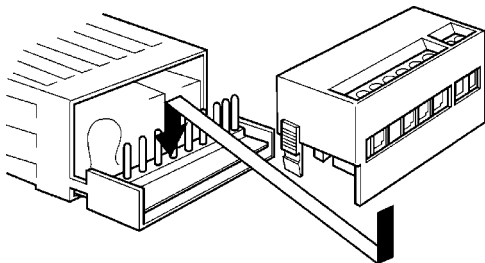

■ WIRING TERMINALS

The voltage output (control output) is not electrically insulated from the internal circuits. When using a grounding thermocouple, do not connect the control output terminals to the ground. If the control output terminals are connected to the ground, errors will occur in the measured temperature values, as a result of leakage current.

Standard insulation is applied to the power supply I/O sections. If reinforced insulation is required, connect the input and output terminals to a device without any exposed current-carrying parts or to a device with standard insulation suitable for the maximum operating voltage of the power supply I/O section.

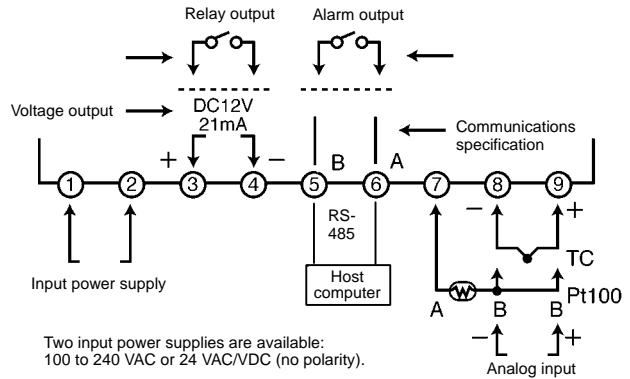

■ WIRING PRECAUTIONS

E5GN

- Connect the terminals as specified below.

Terminal No.	Cables	Pin terminals
1 to 6	AWG24 to AWG14	2.1 dia. max.
7 to 9	AWG28 to AWG22	1.3 dia. max.

- The exposed current-carrying part to be inserted into terminals must be 5 to 6 mm.

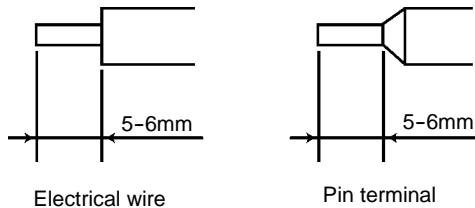

- Tighten the terminal screws to the torque specified below.

Terminal No.	Screw	Maximum tightening torque
1 to 6	M2.6	0.24 N•m (2.5 kgf•cm)
7 to 9	M2	0.13 N•m (1.4 kgf•cm)

Operation

INITIAL SETUP

On previous Controllers, sensor input type, alarm type and control period were set on DIP switches. These hardware settings are now set in parameters in setup menus. The and keys are used to switch between setup menus, and the amount of time that you hold the keys down determines which setup menu you move to. This section describes two typical examples.

Note: On the E5GN, the Key is the Key.

1. ON/OFF Control

Typical Application Examples

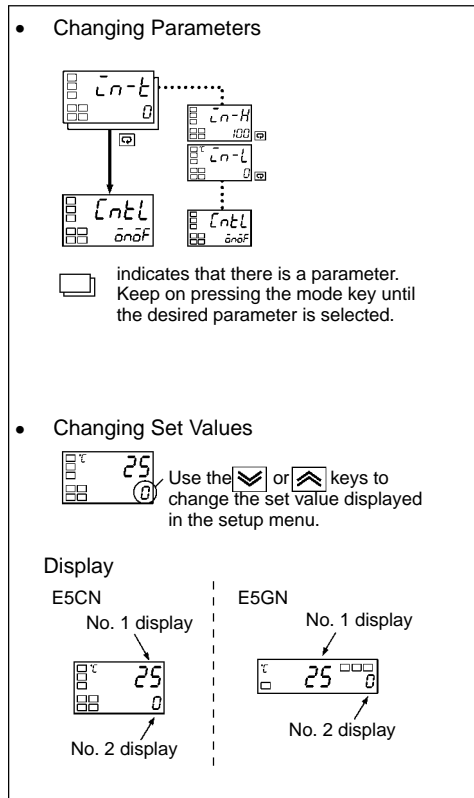

Typical Example

Input type:	0 K thermocouple -200 to 1300°C
Control method:	ON/OFF control
Alarm type:	2 upper limit
Alarm value 1:	20°C (For setting deviation)
Set point:	100°C

Change only the alarm value 1 and set point. The rest must be left as default settings.

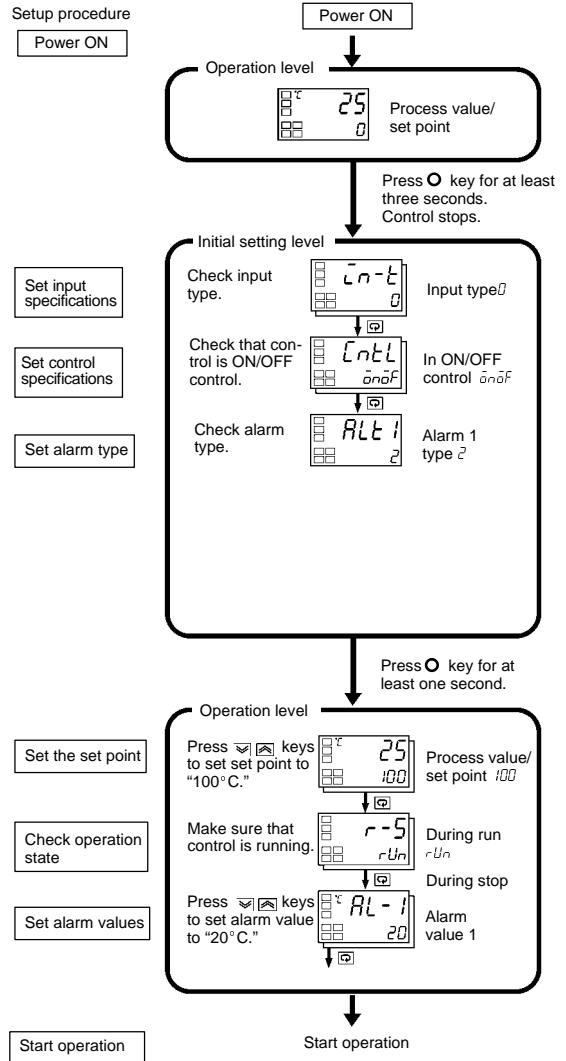

2. PID Control Using Auto-tuning

Changing Parameters

Changing Set Values

Display

Model	No. 1 display	No. 2 display
E5CN	25	0
E5GN	25	0

Typical Example

Input type: 4 T thermocouple -200 to 400°C
 Control method: PID control
 ST (self-tuning): OFF
 Calculate PID constants by AT (auto-tuning).
 Alarm type: 2 upper limit
 Alarm value 1: 30°C (For setting deviation)
 Set point: 150°C

Setup procedure

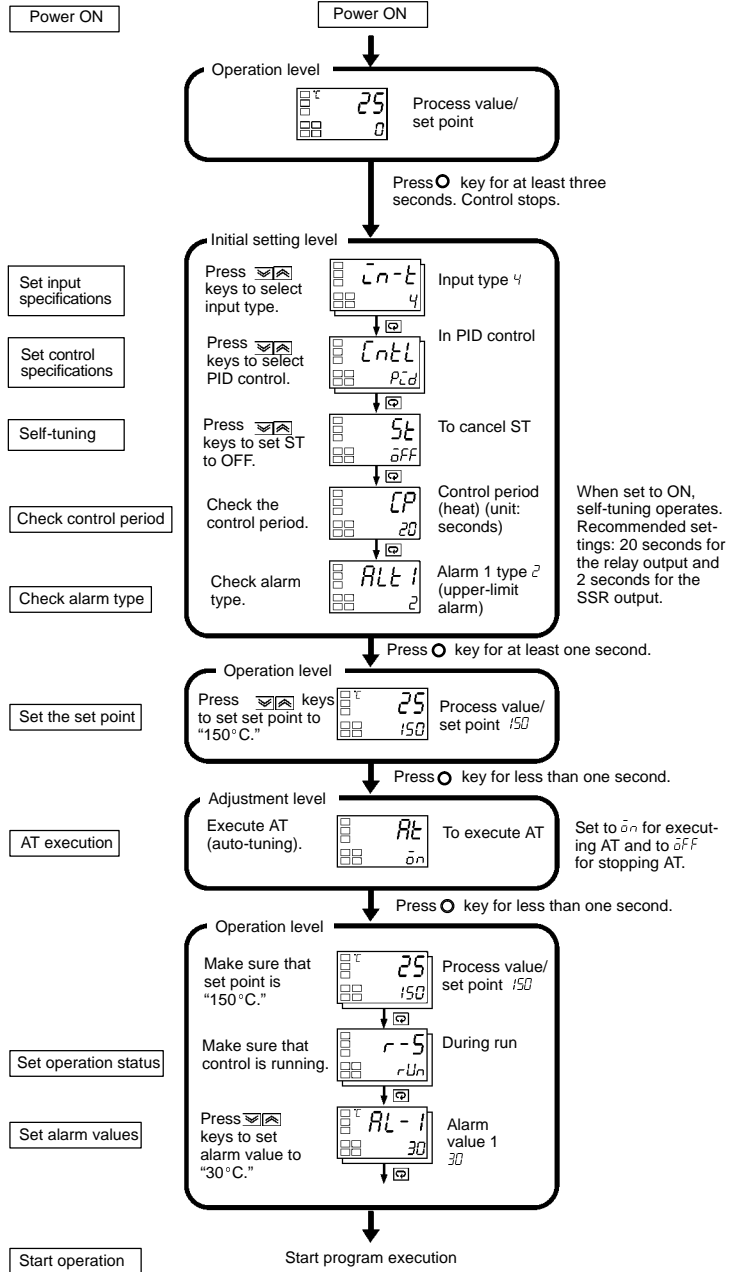

PV/SP

After AT execution.
 25
 150

During AT execution.
 25
 100

While AT is being executed, SP will flash.

After AT execution.
 AL
 OFF

During AT execution.
 AL
 ON

Specification Setting After Turning ON Power

OUTLINE OF OPERATION PROCEDURES

Key Operation

In the following descriptions, all the parameters are introduced in the display sequence. Some parameters may not be displayed depending on the protect settings and operation conditions.

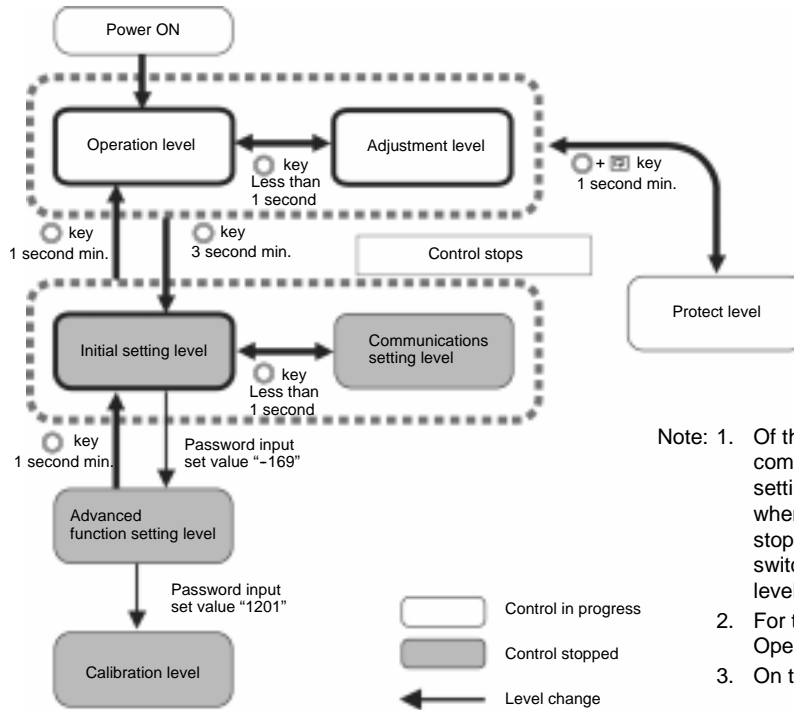

- Note: 1. Of these levels, the initial setting level, communications setting level, advanced function setting level and calibration level can be used only when control has stopped. Note that control is stopped when these four levels are selected. When switched back to the operation level from one of these levels, control will start.
2. For the calibration mode, refer to the relevant Operation Manual (H100 or H101).
3. On the E5GN, the Key is the Key.

DESCRIPTION OF EACH LEVEL

Operation Level

This level is displayed when you turn the power ON. You can move to the protect level, initial setting level and adjustment level from this level.

Normally, select this level during operation. During operation, the process value, set point and manipulated variable can be monitored, and the alarm value and upper- and lower-limit alarms can be monitored and modified.

Adjustment Level



To select this level, press the key once for less than one second.

This level is for entering set values and offset values for control. This level contains parameters for setting the set values, AT (auto-tuning), communications writing enable/disable, hysteresis, multi-SP, input shift values, heater burnout alarm (HBA) and PID constants. You can move to the top parameter of the operation level or initial setting level from here.

Initial Setting Level

To select this level, press the key for at least three seconds in the operation level. This level is for specifying the input type, selecting the control method, control period, setting direct/reverse action and alarm type. You can move to the advanced function setting level or communications setting level from this initial setting level. To return to the operation level, press the key for at least one second. To move to the communications setting level, press the key once for less than one second.

Protect Level

To select this level, simultaneously press the  and  keys for at least one second. This level is to prevent unwanted or accidental modification of parameters. Protected levels will not be displayed, and so the parameters in that level cannot be modified.

Communications Setting Level

To select this level, press the  key once for less than one second in the initial setting level. When the communications function is used, set the communications conditions in this level. Communicating with a personal computer (host computer) allows set points to be read and written, and manipulated variables to be monitored.

Advanced Function Setting Level

To select this level, you must enter the password ("169") in the initial setting level.

You can move only to the calibration level from this level.

This level is for setting the automatic return of display mode, MV limiter, event input assignment, standby sequence, alarm hysteresis, ST (self-tune) and to move to the user calibration level.

Calibration Level

To select this level, you must enter the password ("1201") in the advanced function setting level. This level is for offsetting deviation in the input circuit.

You cannot move to other levels by operating the keys on the front panel from the calibration level. To cancel this level, turn the power OFF then back ON again.

■ SPECIFICATION SETTING (AFTER TURNING ON POWER)

Initial Setting Level

This level is used for setting basic specifications of the Temperature Controller. Using this level, set the input type for selecting the input to be connected such as the thermocouple or platinum resistance thermometer and set the range of set point and the alarm mode.

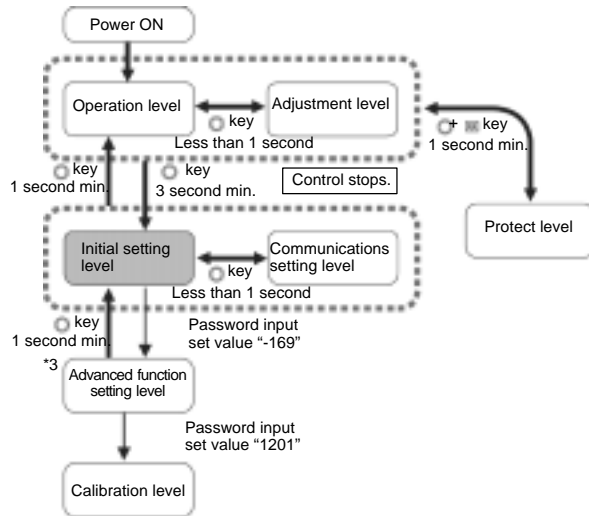

The move from the operation level to the initial setting level, press **⊙** key for three seconds or more.

The initial setting level is not displayed when "initial/communications protection" is set to "2." This initial setting level can be used when "initial setting/communications protection" is set to "0" or "1."

The "scaling upper limit," "scaling lower limit," and "decimal point" parameters are displayed when an analog voltage input is selected as the input type.

Initial setting level

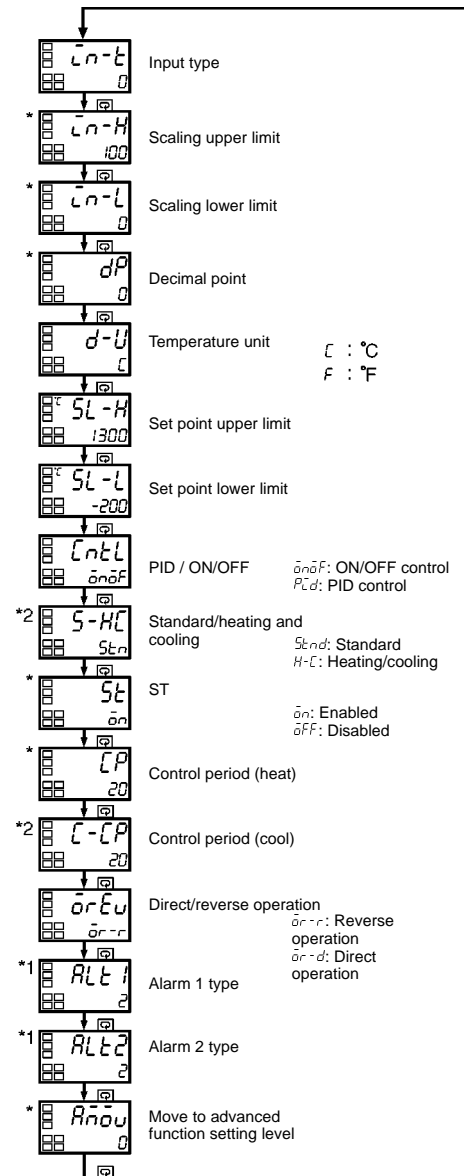

To return to the operation level, press the **⊙** key for longer than one second

*Not displayed as default setting.

- Note:
1. Displayed only with models provided with an alarm function.
 2. Displayed only with the E5CN provided with a two-point alarm function.
 3. Advanced function setting level is for E5CN models only.

■ INPUT TYPE

Using a Thermocouple Input Type

When using a thermocouple input type, follow the specifications listed in the following table.

Input type	Specifications	Set Value	Input Temperature Range
Thermocouple	K	0	-200 to 1300 (°C) /-300 to 2300 (°F)
		1	-20.0 to 500.0 (°C) /0.0 to 900.0 (°F)
	J	2	-100 to 850 (°C) /-100 to 1500 (°F)
		3	-20.0 to 400.0 (°C) /0.0 to 750.0 (°F)
	T	4	-200 to 400 (°C) /-300 to 700 (°F)
	E	5	0 to 600 (°C) /0 to 1100 (°F)
	L	6	-100 to 850 (°C) /-100 to 1500 (°F)
	U	7	-200 to 400 (°C) /-300 to 700 (°F)
	N	8	-200 to 1300 (°C) /-300 to 2300 (°F)
	R	9	0 to 1700 (°C) /0 to 3000 (°F)
	S	10	0 to 1700 (°C) /0 to 3000 (°F)
B	11	100 to 1800 (°C) /300 to 3200 (°F)	
Non-contact temperature sensor ES1A	K10 to 70°C	12	0 to 90 (°C) /0 to 190 (°F)
	K60 to 120°C	13	0 to 120 (°C) /0 to 240 (°F)
	K115 to 165°C	14	0 to 165 (°C) /0 to 320 (°F)
	K160 to 260°C	15	0 to 260 (°C) /0 to 500 (°F)
Analog input	0 to 50mV	16	One of following ranges depending on the results of scaling: 1999 to 9999, 199.9 to 999.9

Note: The initial settings are: 0: -200 to 1300°C/-300 to 2300°F.

Using a Platinum Resistance Thermometer Input Type

When using the platinum resistance thermometer input type, follow the specifications listed in the following table.

Input type	Specifications	Set Value	Input Temperature Range
Platinum resistance thermometer	Pt100	0	-200 to 850 (°C) /-300 to 1500 (°F)
		1	-199.9 to 500.0 (°C)/-199.9 to 900.0 (°F)
		2	0.0 to 100.0 (°C) /0.0 to 210.0 (°F)
	JPt100	3	-199.9 to 500.0 (°C)/-199.9 to 900.0 (°F)
4		0.0 to 100.0 (°C) /0.0 to 210.0 (°F)	

Note: 1. The initial settings are: 0: Pt100 -200 to 850°C/-300 to 1500°F.
2. The ES1A Non-contact Temperature Sensor will be available soon.

ALARM 1 AND ALARM 2

For the alarm 1 and alarm 2, select alarm types out of the 12 alarm types listed in the following table.

Set Value	Alarm Type	Alarm Output Operation	
		When X is positive	When X is negative
0	Alarm function OFF	Output OFF	
1*1	Upper- and lower-limit (deviation)		*2
2	Upper-limit (deviation)		
3	Lower-limit (deviation)		
4*1	Upper- and lower-limit range (deviation)		*3
5*1	Upper- and lower-limit with standby sequence (deviation)		*4
6	Upper-limit with standby sequence (deviation)		
7	Lower-limit with standby sequence (deviation)		
8	Absolute-value upper-limit		
9	Absolute-value lower-limit		
10	Absolute-value upper-limit with standby sequence		
11	Absolute-value lower-limit with standby sequence		

*1: With set values 1, 4 and 5, the upper and lower limit values can be set independently for each alarm type and are expressed as "L" and "H."

Following operations are for cases when an alarm set point is "X" or negative.

*2: Set value: 1, upper- and lower-limit alarm

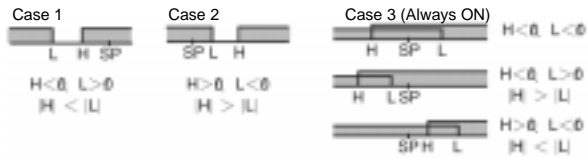

*3: Set value: 4, upper- and lower-limit range

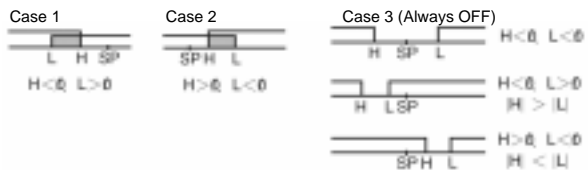

*4: Set value: 5, upper- and lower-limit with standby sequence

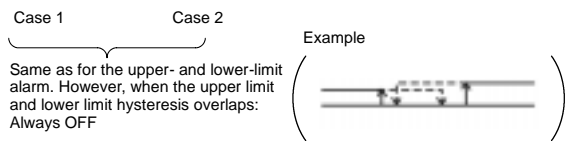

Example: When the alarm is set ON at 110°C/°F or higher.

• When an alarm type other than the absolute-value alarm is selected

(For alarm types 1 to 7)
The alarm value is set as a deviation from the set point.

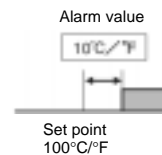

• When the absolute-value alarm is selected

(For alarm types 8 to 11)
The alarm value is set as an absolute value from the alarm value of 0°C/F.

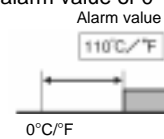

PARAMETERS

Parameters related to setting items for each level are marked in boxes in the flowcharts and brief descriptions are given as required. At the end of each setting item, press the mode key to return to the beginning of each level.

Display

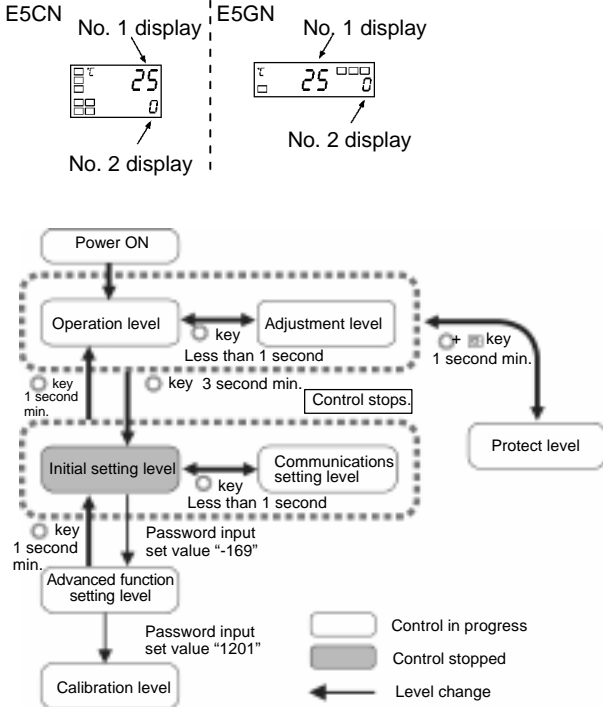

Note: Advanced function levels are for E5CN.

Operation Level

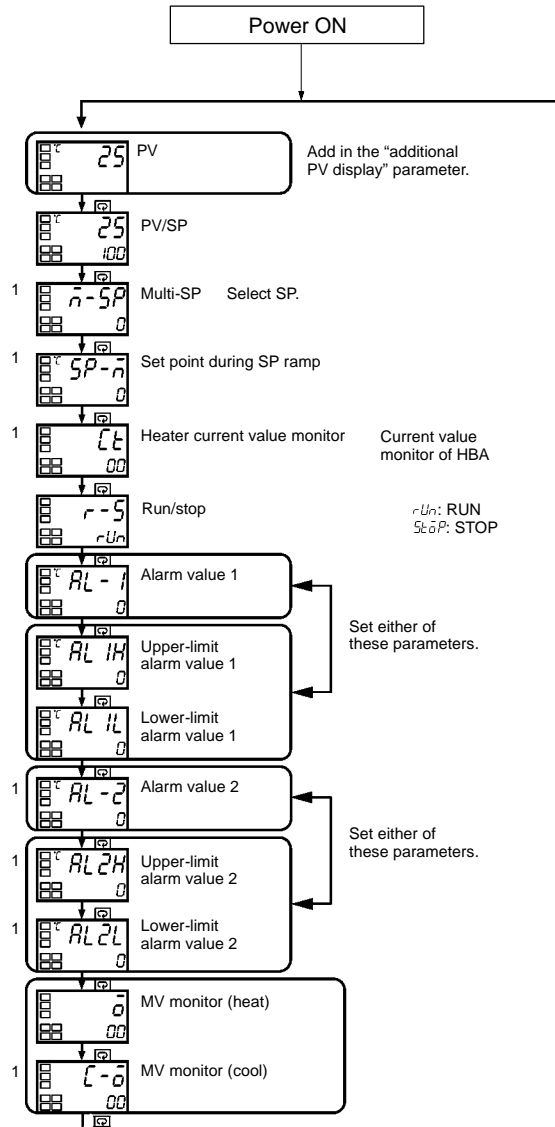

Note: 1. For E5CN only.

Initial Setting Level

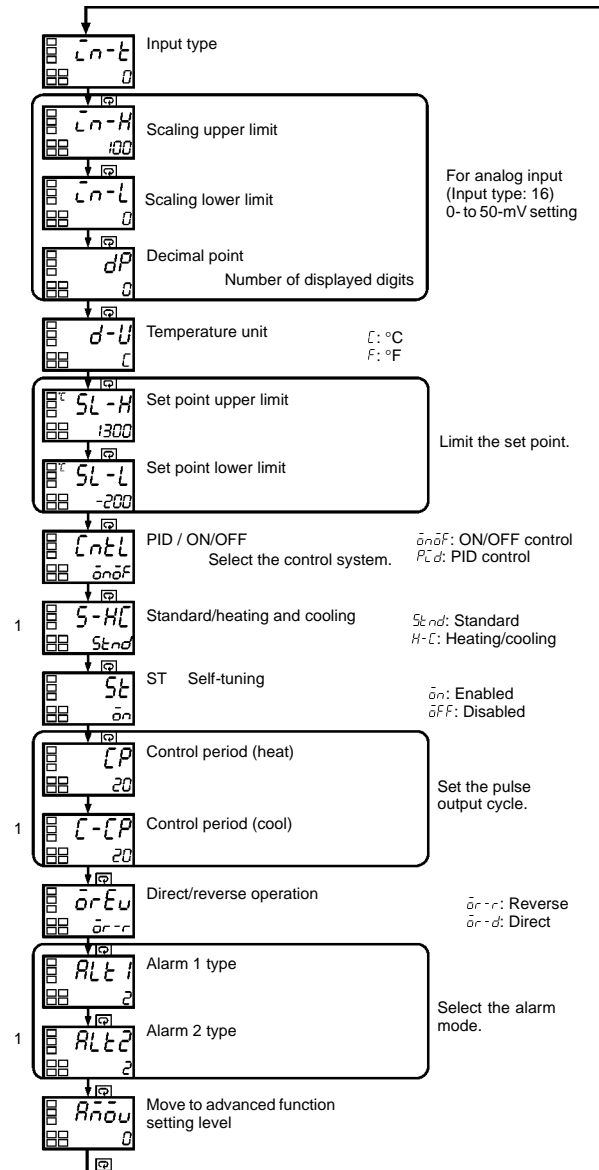

Note: 1. For E5CN only.

Adjustment Level

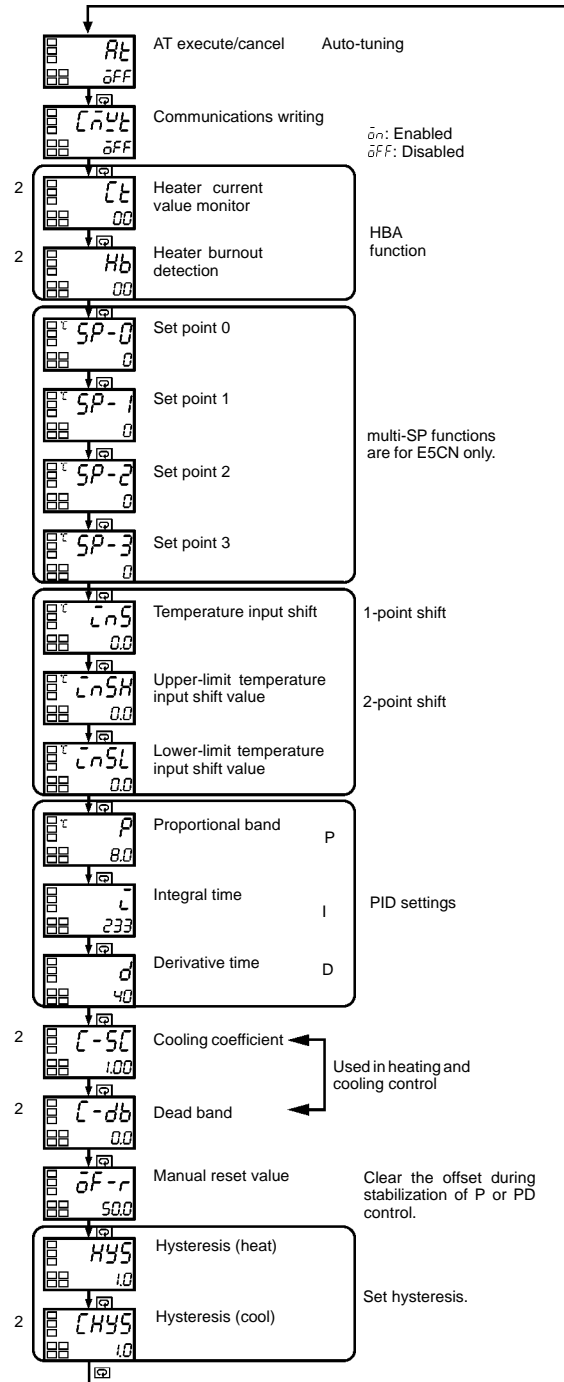

Note: 2. For E5CN only.

Protect Level



Operation/adjustment protection

Restricts display and modification of menus in the operation and adjustment levels.

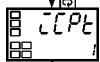

Initial setting/communications protection

Restricts display and modification of menus in the initial setting, operation level and adjustment levels.

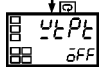

Setting change protection

Protects changes to setups by operating the front panel keys.

Operation/Adjustment Protection

The following table shows the relationship between set values and the range of protection.

Level		Set value			
		0	1	2	3
Operation level	PV	○	○	○	○
	PV/SP	◎	◎	◎	◎
	Other	◎	◎	X	X
Adjustment level		◎	X	X	X

When this parameter is set to "0," parameters are not protected.

Default setting: 0

- ◎ : Can be displayed and changed
- : Can be displayed
- × : Cannot be displayed and move to other levels not possible

Initial Setting/Communications Protection

This protect level restricts movement to the initial setting level, communications setting level and advanced function setting level.

Set value	Initial setting level	Communications setting level	Advanced function setting level
0	○	○	○
1	○	○	X
2	X	X	X

Default setting: 1

- : Move to other levels possible
- × : Move to other levels not possible

Setting Change Protection

This protect level protects setup from being changed by operating the keys on the front panel.

Set value	Description
OFF	Setup can be changed by key operation.
ON	Setup cannot be changed by key operation. (The protect level, can be changed.)

Default setting: OFF





Communications Setting Level

Set the E5CN/E5GN communications specifications in the communications setting level. For setting communications parameters, use the E5CN/E5GN panel. The communications parameters and their settings are listed in the following table.



Parameter	Displayed characters	Set (monitor) value	Set value
Communications unit No.	<i>U-nō</i>	0 to 99	0.1 to 99
Baud rate	<i>bP5</i>	1.2/2.4/4.8/9.6/19.2 (kbps)	1.2/2.4/4.8/9.6/19.2
Data bits	<i>LEn</i>	7/8 (bit)	7/8 (bit)
Stop bits	<i>5bct</i>	1/2	1/2 (bit)
Parity	<i>P-rty</i>	None, even, odd	nōnE/EUEn/ōdd

Note: The highlighted values indicate default settings.

Before executing communications with the E5CN/E5GN, set the communications unit No., baud rate, etc., through key operations as described below. As for other operations, refer to the relevant Operation Manual.

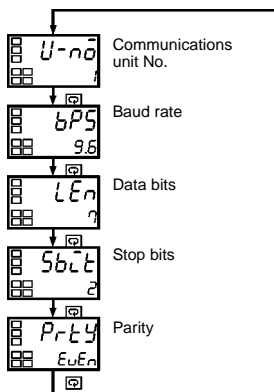
1. Press the  key for at least three seconds in the "operation level." The level moves to the "initial setting level."
2. Press the  key for less than one second. The "initial setting level" moves to the "communications setting level."
3. Pressing the  key advances the parameters as shown in the following figure.
4. Press the  or  keys to change the parameter setups.



Note: On the E5GN, the  Key is the  Key.

Set each communications parameter to match those of the communicating personal computer.

Communications Unit No. (*U-nō*)

When communicating with the host computer, the unit number must be set in each Temperature Controller so that the host computer can identify each Temperature Controller. The number can be set in a range from 0 to 99 in increments of 1. The default setting is 1. When using more than one Unit, be careful not to use the same number twice. Duplicate settings will cause malfunction. This value becomes valid when the power is turned OFF and ON again.

Baud Rate (*bP5*)

Use this parameter to set the speed of communications with the host computer. It can be set to one of the following values; 1.2 (1200 bps), 2.4 (2400 bps), 4.8 (4800 bps), 9.6 (9600 bps), and 19.2 (19200 bps). This setting becomes valid when the power is turned OFF and ON again.

Data Bits (*LEn*)

Use this parameter to change the communications data bit length to 7 bits or 8 bits.

Stop Bits (*5bct*)

Use this parameter to change the communications stop bit to 1 or 2.

Parity (*P-rty*)

Use this parameter to set the communications parity to None, Even, or Odd.

■ TROUBLESHOOTING

When an error occurs, an error code will be displayed on the No. 1 display. Check the contents of an error and take appropriate countermeasures.

No. 1 display	Type of error	Countermeasures
5Err	Input error	Check the wiring of inputs for miswiring, disconnections, short-circuits, and the input type.
E111	Memory error	First, turn the power OFF then back ON again. If the display remains the same, the Unit must be repaired. If the display is restored, then a probable cause can be external noise affecting the control system. Check for external noise.
CCCC	Display range over	Though not error, this is displayed when the process value exceeds the display range when the control range is larger than the display range.
3333		<ul style="list-style-type: none"> When less than "-1999" C C C C When larger than "9999" 3 3 3 3
HErr	HB error	First, turn the power OFF then back ON again. If the display remains the same, the controller must be repaired. If the display is restored, then a probable cause can be electrical noise affecting the control system. Check for electrical noise.

Note: Error will be displayed only when the display is set for the PV or PV/SP.

Fuzzy Self-tuning

The fuzzy self-tuning (ST) is a function that automatically calculates an optimum PID constant depending on items to be controlled.

■ FEATURE

The Temperature Controller determines when to execute this fuzzy self-tuning.

■ FUNCTIONS

SRT: Performs PID tuning according to the step response method when the SP is changed.

LCT: Performs PID tuning according to the limit cycle method when the SP is changed.

Requirements for SRT Functionality

The ST will be executed according to the step response method when the following conditions are satisfied when operation is started or when the SP is changed.

When operation is started	When SP is changed
<ol style="list-style-type: none"> The SP at the startup is different from the SP at the time the previous SRT was executed. (See Note.) The temperature upon startup is smaller than the SP in the reverse operation and larger than the SP in the direct operation. Restarting of operation is not due to an input error. <p>Note: The "SP that existed when the previous SRT was executed" refers to the SP used for obtaining the PID constant in the previous SRT.</p>	<ol style="list-style-type: none"> The SP after change is different from the SP at the time the previous SRT was executed. (See Note.) In the reverse operation, the value obtained by deducting the SP before change from the SP after change is larger than the ST stable range. In the direct operation, the value obtained by deducting the SP after change from the SP before change is larger than the ST stable range. The SP change width is larger than the current proportional band $\times 1.27 + 4$. The temperature is in the stable state. (It can be in the balanced state if no output is generated when the power is turned ON.)

If the SP is changed while SRT is being executed and if SRT completion conditions are satisfied, no PID change will take place.

Stabilization State

Measured values remain in the stable range for a certain period of time.

Balanced State

Output is 0% for 60 seconds and measured values fluctuate within the width of the stable range.

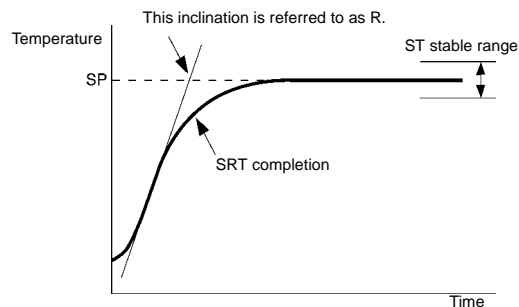

Precautions

■ OPERATING ENVIRONMENT

- Use the Temperature Controller within the rated operating temperature, storage temperature, and operating humidity specified for each model.
- Use the Temperature Controller according to the performance specifications such as vibration, shock, and degree of protection specified for each model.
- Do not use the Temperature Controller in places where it is subject to dust or corrosive gases.
- Install the Temperature Controller away from the devices that generate high-frequency noise.

■ SERVICE LIFE

The service life of relays used for the control output or alarm output varies depending on mostly switching conditions. Be sure to confirm their performance under actual operating conditions and do not use them beyond the allowable number of switchings. If they are used in a deteriorated condition, insulation between circuits may be damaged and, as a result, the Temperature Controller itself may be damaged or burned.

The service life of electronic devices such as Temperature Controllers is determined not only by the number of switchings of relays, but also by the service life of internal electronic components. The component service life is affected by the ambient temperature: the higher the temperature becomes, the shorter the service life becomes; the lower the temperature becomes, the longer the service life becomes. For this reason, the service life can be extended by lowering the internal temperature of the Temperature Controller.

When two or more Temperature Controllers are mounted horizontally close to each other or vertically next to each other, the internal temperature will increase, due to heat radiated by the Temperature Controllers, and the service life will decrease. In these situations, forced cooling by fans or other means of air ventilation will be required to cool down the Temperature Controllers. When providing forced cooling, however, be careful not to cool down the terminals solely, to avoid measurement errors.

■ ORDERING PRECAUTIONS

Units separately sold, such as Control Output Units and Current Transformers, are specified for each Temperature Controller. Be sure to order appropriate units according to the application requirements.

■ INSTALLATION

Mounting

Mount the Temperature Controller so that it is horizontally level.

Connection

When extending or connecting the thermocouple lead wire, be sure to use compensating wires that match the thermocouple types.

When extending or connecting the lead wire of the platinum resistance thermometer, be sure to use wires that have low resistance.

When wiring the platinum resistance thermometer to the Temperature Controller, keep the wire route as short as possible. Separate this wiring away from the power supply wiring and load wiring to avoid inductive or other forms of noise.

Do not use empty terminals.

Crimp Terminal Connection

Use crimp terminals that match M3.5 screws. M3.5 x 8 self-rising screws are used.

E5GN

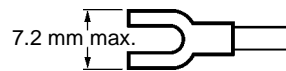

Be careful not to tighten the terminals screws excessively.

Soldering Connection

The self-rising screws provide easy soldering connection. Strip the lead wire by a length of 6 to 8 mm.

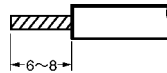

■ OPERATING PRECAUTIONS

For Temperature Controllers with alarm outputs, alarm output may not be generated correctly when an abnormality occurs in the device. A separate alarm device should be incorporated into the system.

To ensure proper performance, parameters of the Temperature Controllers are set to default values before they are shipped. Change these parameters depending on actual applications. If left unchanged, the Temperature Controller will operate under the default settings.

It takes several seconds for the relay to turn ON from the moment the power is turned ON. Consider this time when incorporating Temperature Controllers in a sequence circuit.

When pulling out the Temperature Controller body, do not apply excessive force. After the body is removed, be careful not to apply any shock to the connectors or other electronic components on the PCB.

Models without any specification on their degree of protection or those with IP□0 do not offer a waterproofing feature.

OMRON[®]**OMRON ELECTRONICS, INC.**One East Commerce Drive
Schaumburg, IL 60173**1-800-55-OMRON****OMRON CANADA, INC.**885 Milner Avenue
Scarborough, Ontario M1B 5V8**416-286-6465**