

6003 Joker combination wrench, 36 x 460 mm

6003 Joker combination wrench - Open-end with return angle of just 15. When things get tight.



EAN:	4013288218896	Size:	0x0x0 mm
Part number:	05020507001	Weight:	0 g
Article number:	6003 Joker	Country of origin:	CZ
		Customs tariff number:	82041100

- Especially suitable for tight spaces
- The special mouth geometry expands the placement possibilities of the tool
- The low return angle in the mouth "takes" the screw every 15°
- Slim ring side angled by 15°
- With Take it easy tool finder: colour coding by size

As the installation space becomes increasingly tight during screwdriving, tools are necessary that enable users to work successfully even in such situations. Narrow spaces require additional placement points of the tool. Can spanners be modified so that the placement possibilities of the tool increase? The combination of the 7.5° pivoted mouth and the double hexagon geometry doubles the placement points. A repeated 180° turn of the wrench around the longitudinal axis during screwdriving provides four placement possibilities, and bolts or screw heads can be engaged every 15°. The Joker 6003 with its smart mouth geometry significantly expands the range of uses in confined spaces. The Joker 6003 will automatically find the respective placement point after every turn. The slim yet robust ring side is angled by 15° to the tool axis. The high-quality surface treatment achieves a high and long-lasting corrosion protection. With tool finder Take it easy: colour coding by size.

Web link

https://products.wera.de/en/joker_6003_joker_combination_wrench_open-end_with_return_angle_of_just_15_when_things_get_tight_6003_joker.html

Wera - 6003 Joker
05020507001 - 4013288218896

Wera Werkzeuge GmbH
Korzter Straße 21-25
D-42349 Wuppertal
Tel: +49 (0)2 02 / 40 45-0
E-Mail: info@wera.de

6003 Joker combination wrench - Open-end with return angle of just 15. When things get tight.

For very tight spaces



The Joker 6003 combination wrench with its special mouth geometry – an open-end offset by 7.5° and the double hexagon geometry – doubles the placement possibilities when repeatedly turning the wrench 180° around the longitudinal axis. Bolts and screw heads can be "accessed" every 15°. The Joker 6003 will automatically find the respective placement point after every turn.

Joker 6003: For pivoting angles under 30°

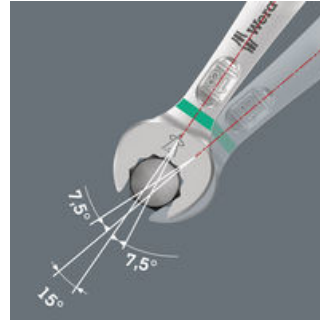

Thanks to the mouth side pivoted by 7.5°, double hexagon geometry and an adjusted application method (placement – screwdriving – turning – replacement – screwdriving – turning, etc), even screwdriving challenges allowing a pivoting angle of less than 30° can be solved.

Double-hex geometry

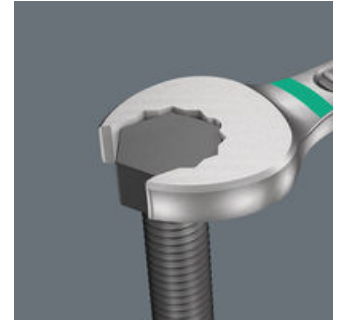

The double hexagon geometry on the mouth and ring sides secures the positive connection with the screw head or bolt and reduces the risk of slipping.

Joker 6003: Angled ring side

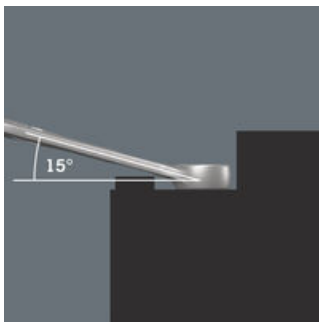

The ring side is angled at 15° to the tool axis to prevent injury.

“Take it easy” tool finder



Take it easy tool finder system - with profile and size colour-coding for quick and easy tool selection. Colour-coded system for hexagon drive screws (L-Keys, Zyklop bit sockets), external hex drive screws and nuts (Joker wrenches, Zyklop sockets and Zyklop bit sockets with holding function), and TORX® drive screws (L-Keys, Zyklop bit sockets).

Web link

https://products.wera.de/en/joker_6003_joker_combination_wrench_open-end_with_return_angle_of_just_15_when_things_get_tight_6003_joker.html

Wera - 6003 Joker
05020507001 - 4013288218896







Wera Werkzeuge GmbH
Korzter Straße 21-25
D-42349 Wuppertal
Tel: +49 (0)2 02 / 40 45-0
E-Mail: info@wera.de

6003 Joker combination wrench, 36 x 460 mm



6003 Joker combination wrench - Open-end with return angle of just 15. When things get tight.

Further versions in this product family:

	 mm	 mm	 mm	 mm	 mm	 mm
05020190001 ¹⁾	5.5	105	16	4	10	6
05020198001 ¹⁾	6	105	16	4	10	6
05020199001 ¹⁾	7	110	17.7	4.2	11.5	6
05020200001	8	115	19	4.5	12.5	7
05020219001 ¹⁾	9	120	21	4.8	13.5	7
05020201001	10	125	22	5	15	7
05020202001	11	135	24.5	5	17	8
05020203001	12	148	26	5.5	18	8.5
05020204001	13	160	27	6	19	8.5
05020205001	14	167	29	6	20	8.5
05020206001	15	174	32	6	22	8.5
05020207001	16	182	35	6.5	23	10
05020208001	17	190	38	6.5	24.5	10
05020209001	18	210	39	7.5	26	11.5
05020210001	19	230	42	7.5	27.5	11.5
05020500001 ¹⁾	20	230	45	7.5	29	13
05020501001 ¹⁾	21	260	47	7.5	30	13
05020502001 ¹⁾	22	260	49	7.5	31.5	13
05020503001 ¹⁾	24	280	53	8	36	14
05020504001 ¹⁾	27	300	60	8.5	40	14.5
05020505001 ¹⁾	30	330	66	9	43	16
05020506001 ¹⁾	32	360	70	9.5	45.5	16.5
05020507001¹⁾	36	460	80	10	50.5	18

1) Available from May 2021

Web link

https://products.wera.de/en/joker_6003_joker_combination_wrench_open-end_with_return_angle_of_just_15_when_things_get_tight_6003_joker.html

Wera - 6003 Joker
05020507001 - 4013288218896

Wera Werkzeuge GmbH
Korzter Straße 21-25
D-42349 Wuppertal
Tel: +49 (0)2 02 / 40 45-0
E-Mail: info@wera.de