

# FIBOX EURONORM II

## ALUMINIUM ENCLOSURES

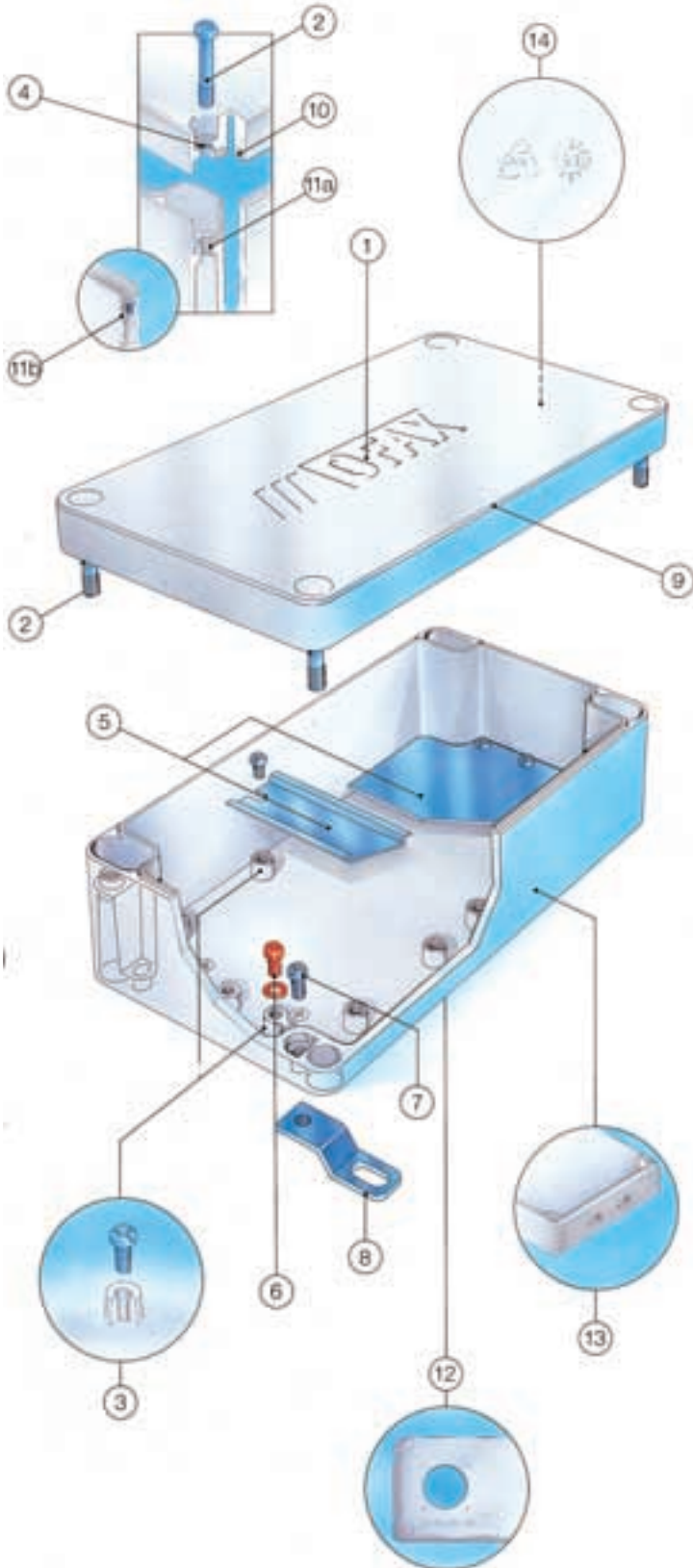







1. Enclosure covers can be custom designed. Modifications include holes, cutouts, flanges, and frames. Even external changes such as cooling ribs (heat sinks) are possible. OEMs receive the enclosure ready for assembly.
2. Cover screws are designed for automatic assembly using normal tools or PosiDrive Phillips screwdrivers. Slightly ferrite, FI stainless screws work with magnetised drivers.
3. This enclosure has more internal mounting points than other enclosures on the market. There are threaded M4 or M6 mounting pods at both interior ends of the bases. Along the interior sides, the enclosure bases have rows of pods ready for M3 Taptite (smaller enclosures) and M5 Taptite (larger enclosures). Alternatively, pods can be machined for M4 or M5 mounting screws. Helicoil inserts are available in English thread sizes.

The large number of mounting pods, especially in the bigger enclosures, creates many alternatives for mounting components. Various sized mounting plates are easily installed. DIN rails can be mounted either vertically or horizontally permitting high density terminal block installation.

Usable internal depth is maximised as Euronorm II has the lowest height mounting pods on the market.

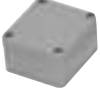
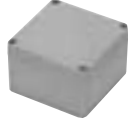
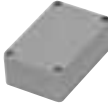
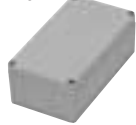
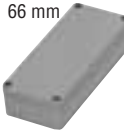

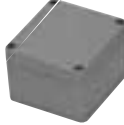
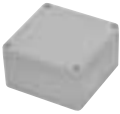
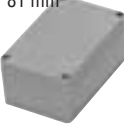

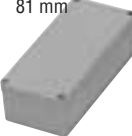
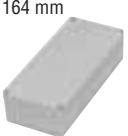

4. A special retainer keeps cover screws captive. No more lost hardware.
5. A variety of mounting plate sizes are available, plus TS35 and TS15 DIN rail cut to size.
6. Proper electrical earthing is ensured with copper plated screws and paint free grounding pods.
7. The enclosures can be mounted through the base. The mounting holes are outside the gasket area; maintaining the water tight seal. Oval shaped mounting holes accommodate mounting centre variations.
8. Optional stainless steel wall mounting plates permit mounting without opening the enclosure.
9. The Euronorm II features a slightly bevelled edge design creating a modern look.
10. Robotically applied, foamed in place PUR gaskets are into the unique designed gasket groove. The tight adhesion and low compression set of PUR gasket material insures protection ratings of NEMA 4 and IP 66/67.
11. Enclosure bases are tapped to receive cover screws, either M4 or M6, depending upon enclosure size. Optional special thread types are available, as are Helicoil special steel thread inserts which prevent cover screws from corroding even in saltwater environments.
12. Customisation of the back and sides of the enclosure can be supplied by Fibox.
13. Larger enclosures have lots of space for mounting instruments, switches, sensors, indicators and connectors. Smooth sides permit easy machining and allow decal and screen printing. Fibox can customise the enclosure with openings, cut-outs, holes and tapped holes. Changes can add unique options, for example, conduit hub openings or cooling fins.
14. Manufactured using unique techniques. These enclosures have straight sides (no draft angle) which means conduit and cable fitting are at right angles, insuring stress free connections. Further, straight sides mean that enclosures can be securely "ganged" together without gaps.

# FIBOX EURONORM II

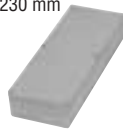
FIBOX EURONORM II ALUMINIUM IP66 / IP67, IK 08	Z x C	ORDER SYMBOL		FIBOX EURONORM II ALUMINIUM IP66 / IP67, IK 08	Z x C	ORDER SYMBOL	
	B x A				L x S mm		
AL 050503 Y x X 50 mm 45 mm 	Z / C 31.5 x 20.5 B x A 45 x 40 L x S 40 x 35	AL 050503		AL 082506 Y x X 252 mm 81 mm 	Z / C 56.5 x 45.5 B x A 231 x 39 L x S 239.5 x 69.5	AL 082506	
AL 060605 Y x X 60 mm 66 mm 	Z / C 46 x 35 B x A 40 x 32.7 L x S 47.5 x 53.5	AL 060605		AL 121208 Y x X 125 mm 124 mm 	Z / C 81 x 64 B x A 95 x 52 L x S 106 x 107.9	AL 121208	
AL 061005 Y x X 100 mm 66 mm 	Z / C 46 x 35 B x A 50 x 46 L x S 87.5 x 53.5	AL 061005		AL 122208 Y x X 222 mm 125 mm 	Z / C 81 x 64 B x A 193 x 52 L x S 204 x 107.9	AL 122208	
AL 061505 Y x X 152 mm 66 mm 	Z / C 46 x 35 B x A 140 x 46 S x L 138 x 53.5	AL 061505		AL 123608 Y x X 362 mm 125 mm 	Z / C 81 x 64 B x A 333 x 52 L x S 344 x 107.9	AL 123608	
AL 080806 Y x X 81 mm 77 mm 	Z / C 56.5 x 45.5 B x A 56 x 39 L x S 69.5 x 63	AL 080806		AL 161609 Y x X 163 mm 162 mm 	Z / C 91 x 74 B x A 130 x 76 L x S 142.6 x 142.6	AL 161609	
AL 081306 Y x X 127 mm 81 mm 	Z / C 56.5 x 45.5 B x A 106 x 39 L x S 114.5 x 69.5	AL 081306		AL 162609 Y x X 263 mm 162 mm 	Z / C 91 x 74 B x A 230 x 76 L x S 240 x 110	AL 162609	
AL 081806 Y x X 177 mm 81 mm 	Z / C 56.5 x 45.5 B x A 156 x 39 L x S 163 x 69.5	AL 081806		AL 163609 Y x X 364 mm 164 mm 	Z / C 91 x 74.2 B x A 330 x 76 L x S 342.6 x 142.6	AL 163609	

External height **Y** External width **X** External depth **Z** Free internal mounting height **C** Mounting plate assembly **B** x **A** Wall mounting **L** x **S**

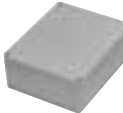
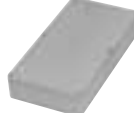
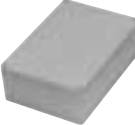
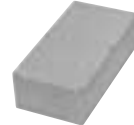
# FIBOX EURONORM II

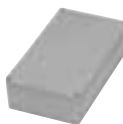
FIBOX EURONORM II ALUMINIUM IP66 / IP67, IK 08	Z x C	ORDER SYMBOL		FIBOX EURONORM II ALUMINIUM IP66 / IP67, IK 08	Z x C	ORDER SYMBOL	
	B x A				L x S mm		
AL 165609 Y x X 564 mm 164 mm 	Z x C 91 x 74.2 B x A 530 x 76 L x S 542.6 x 142.6	AL 165609		AL 236011 Y x X 600 mm 230 mm 	Z x C 110 x 88 B x A 570 x 144 L x S 580 x 210	AL 236011	
AL 232011 Y x X 234 mm 204 mm 	Z x C 111 x 94 B x A 144 x 170 L x S 212.6 x 182.6	AL 232011		AL 314011 Y x X 404 mm 316 mm 	Z x C 111 x 94 B x A 370 x 223.5 L x S 382.5 x 261	AL 314011	
AL 232018 Y x X 230 mm 200 mm 	Z x C 180 x 158 B x A 144 x 170 L x S 210 x 180	AL 232018		AL 314018 Y x X 402 mm 310 mm 	Z x C 180 x 158 B x A 372.5 x 223.5 L x S 358.5 x 294.6	AL 314018	
AL 232811 Y x X 284 mm 234 mm 	Z x C 111 x 94 B x A 250 x 144 L x S 260 x 212.6	AL 232811		AL 316011 Y x X 600 mm 310 mm 	Z x C 110 x 88 B x A 570 x 223.5 L x S 580 x 290	AL 316011	
AL 233311 Y x X 330 mm 230 mm 	Z x C 110 x 89 B x A 300 x 144 L x S 310 x 210	AL 233311		AL 316018 Y x X 600 mm 310 mm 	Z x C 180 x 158 B x A 570 x 223.5 L x S 580 x 290	AL 316018	
AL 233318 Y x X 330 mm 230 mm 	Z x C 180 x 158 B x A 300 x 144 L x S 310 x 210	AL 233318					
AL 234011 Y x X 401 mm 230 mm 	Z x C 110 x 87 B x A 373 x 144 L x S 381 x 210	AL 234011					

External height **Y** External width **X** External depth **Z** Free internal mounting height **C** Mounting plate assembly **B** x **A** Wall mounting **L** x **S**

# FIBOX EURONORM II

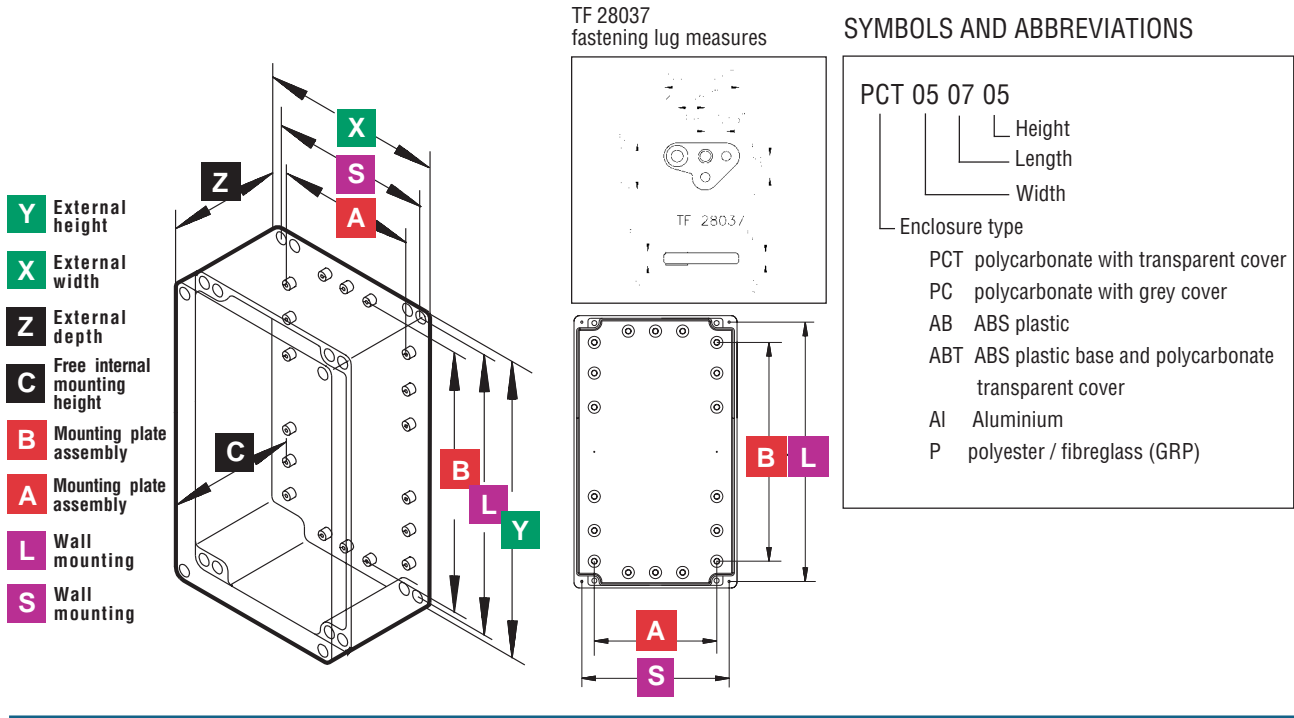

## CIRCUIT BOARD BRACKET

Printed circuit boards and mounting plates often need special mounting supports that offer flexibility in positioning the boards across the enclosure body. Mounting supports also raise the board above the enclosure bottom, especially effective when using two sided boards. This circuit board bracket has a standard E1 (IEC 297-3, DIN 41494) Eurocard screw mounting distance of 89 mm (3.5") accepting M2,5 to M4 screws. The bracket can also be used for nonstandard boards by separating the ends of the bracket (a) from the connector bridge (b). If the bracket is not needed, the adapter parts for each individual mounting pod size can be used only for raising the board above the enclosure body level.

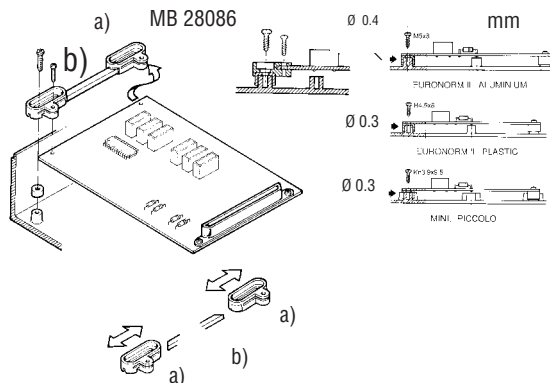

CIRCUIT BOARD BRACKET		
ORDER SYMBOL	Standard Mounting Distance	Remarks
MB 28086	89 mm	Adapter for EURONORM II, PICCOLO, MINI. Direct mount to EK, SOLID, EKI.

# FIBOX EURONORM II

## TECHNICAL INFORMATION FOR EURONORM ALUMINIUM- AND POLYESTER ENCLOSURES

PROPERTY	AISI Cast ALUMINIUM	CONFORMITY TO STANDARDS (UL, CSA, CE, Lloyds, BV, FI)
Ingress Protection (EN 60529)	IP65 to IP66/67	<b>USA</b> Enclosures for Electrical Equipment UL Type 1, 4, 4X, 6, 12 and 13 (50/508)
Impact Resistance (EN 50102)	IK 08	<b>Canada</b> Industrial Control Equipment Enclosures for Electrical Equipment/ULc
Temperature Range Celsius (short term)	-50°...140°C	<b>Europe</b> Safety of Information Technology Equipment EN 60950
Temperature Range Fahrenheit (short term)	-60°...285°F	
Temperature Range Celsius (continuous)	-50°...80°C	
Temperature Range Fahrenheit (continuous)	-60°...175°F	
Polyester Powder Paint Colour	RAL 7001	
Cover Screws	Stainless Steel	
Gasket	PUR/Neoprene	
Chemical Resistance *	Good	





  

PROPERTY	FIBERGLASS	CONFORMITY TO STANDARDS (UL, CSA, CE, Lloyds, BV, FI)
Ingress Protection (EN 60529)	IP65	<b>USA</b> Enclosures for Electrical Equipment NEMA 1, 4, 4X, 6, 12 and 13
Impact Resistance (EN 50102)	IK 08	<b>Canada</b> Industrial Control Equipment Enclosures for Electrical Equipment/ULc
Temperature Range Celsius (short term)	-50°...120°C	<b>Europe</b> Safety of Information Technology Equipment EN 60950
Temperature Range Fahrenheit (short term)	-60°...250°F	
Temperature Range Celsius (continuous)	-40°...80°C	<b>Australia</b> Enclosures for switch gear and control gear AS 3132-1991
Temperature Range Fahrenheit (continuous)	-40°...175°F	UL 746 C 5 in. vertical flame test IEC 695-2-1, Self-extinguishing
Electrical Insulation	Totally insulated 	
Colour	RAL 7001, grey	
Enclosure Flammability Rating	UL94-5V	
Glow Wire test	960°C	
Cover Screws	Stainless Steel	
Gasket	EPDM	
Chemical Resistance *	Good	

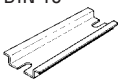
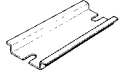



Data subject to change without notice. \*Consult separate raw material data for more detailed information

## ACCESSORIES FOR EURONORM ALUMINIUM ENCLOSURES

Product	Order symbol	Size mm	
 Mounting plate	AM 0808	69 x 64	
	AM 0813	69 x 114	
	AM 0818	69 x 164	
	AM 0825	69 x 240	
	AM 1212	107 x 110	
	AM 1222	107 x 207	
	AM 1236	107 x 347	
	AM 1616	146 x 146	
	AM 1626	146 x 244	
	AM 1636	146 x 346	
	AM 1656	146 x 545	
	AM 2320	215 x 184	
	AM 2328	215 x 264	
	AM 2333	215 x 315	
	AM 2340	215 x 385	
	AM 2360	215 x 586	
	AM 3140	294 x 387	
AM 3160	293 x 585		
 Mounting rail DIN 15	ARM 0610	15 x 88	
	ARM 0615	15 x 140	
	ARM 0808	15 x 65	
	ARM 0813	15 x 115	
	ARM 0818	15 x 165	
	ARM 0825	15 x 240	
 Mounting rail DIN 35	ARH 12	35 x 105	
	ARH 22	35 x 203	
	ARH 36	35 x 343	
	ARH 16	35 x 140	
	ARH 26	35 x 240	
	ARH 1636	35 x 340	
	ARH 1656	35 x 540	
	ARH 2320	35 x 180	
	ARH 2328	35 x 260	
	ARH 2333	35 x 310	
	ARH 40	35 x 383	
	ARH 60	35 x 580	
Earth screw	MR 28550M	M4 x 6	
Earth screw	MR 28546CU	M4 x 6	
Mounting screw	MR 28548ZN	M4 x 6	
Screw set	MRS 28546		
Ground screw	MR 28547CU	M6 x 8	

Product	Order symbol	Size mm	
 Mounting screw	MR 28549ZN		
	MRS 38547		
	MR 10425	M4 x 20	
	MR 10635	M6 x 30	
 Mounting foot kit	MRS 28540	11 x 42	
	MRS 28541	15 x 50	
 Mounting screw	MR 28550	M4 x 6	
	MR 28546CU	M4 x 6	
	MR 28548ZN		
	MRS 38546		
	MR 28547CU	M6 x 8	
	MR 28549ZN	M6 x 8	
	MRS 38547		
	MR 75003	M3	
	MR 75005	M5	
	MRHC 406	M4	
MRHC 609	M6		
 Cover screw	MRS 28544A4	M6 x 30	
	MRS 28545WH	M6 x 30	

## ACCESSORIES FOR EURONORM POLYESTER

Product	Order symbol	Size mm		
 Mounting plate	PM 0808	64 x 69		
	PM 0811	64 x 99		
	PM 0816	64 x 149		
	PM 0819	64 x 179		
	PM 1616	146 x 146		
	PM 1626	146 x 244		
	PM 2526	231 x 240		
	PM 2540	231 x 383		
	PM 4040	390 x 385		
	 Mounting rail DIN 15	PRM 0811	15 x 99	
		PRM 0816	15 x 149	
PRM 0819		15 x 179		
 Mounting rail DIN 35	PRH 2526	35 x 238		
 Hinge kit 1 pair includes screws	AH A/B			
	PH A			
 Mounting lug kit	MRS 28540	11x42		
	MRS 28541	15x50		

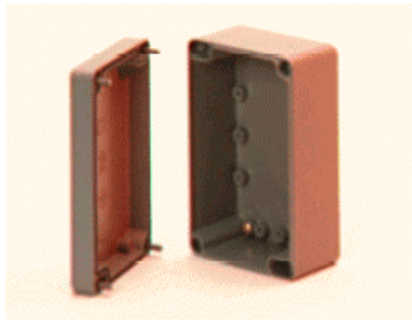

This is a sample photo.

**ORDER SYMBOL:** AL 060605

**EL.number** **EAN:** 6418074004086  
 Sweden: 2536305  
 Denmark: 8212004618  
 Finland: 3423603

**INCLUDING:**  
 Enclosure body, cover with PUR gasket, cover screws, and 2 earth screws.

**APPROVALS:**  
 USA: UL Type 1, 4, 4X, 12, 13 (E75645 Vol.1 Sec.6)  
 EURO: IP 67/IP 66  
 OTHERS: IEC 529

**FIBOX EURONORM II AL**

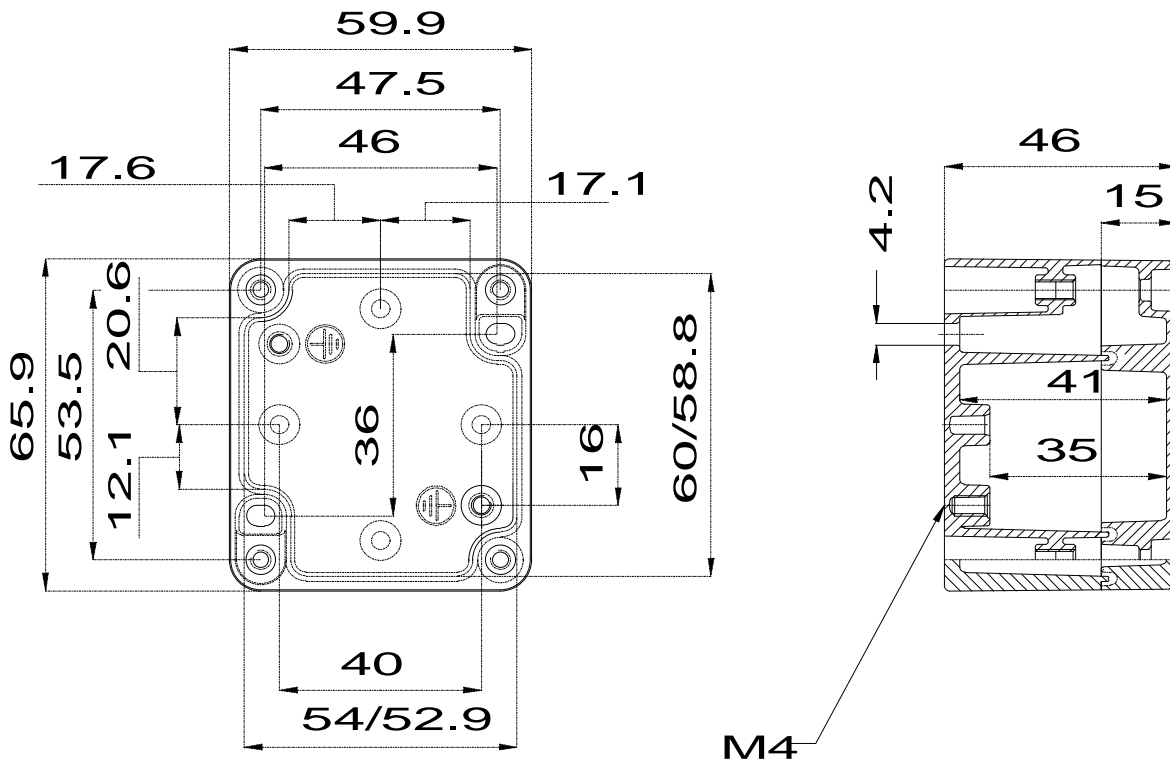

**TECHNICAL INFORMATION:**

Standard colour: RAL 7001  
 Ingress protection: IP 67 (IEC 529)  
 Flame resistance:

Temp.range in cont. use: Max. +80 °C  
 Temp. range of material: - 50 °C - + 120 °C

**ACCESSORIES**

DIN-Rail	ARH 12	DIN-Rail	ARH 26	DIN-Rail	ARM 0818
DIN-Rail	ARH 16	DIN-Rail	ARH 36	DIN-Rail	ARM 0825
DIN-Rail	ARH 1636	DIN-Rail	ARH 40	Fastening lug	MRS 28540
DIN-Rail	ARH 1656	DIN-Rail	ARH 60	Fastening lug	MRS 28541
DIN-Rail	ARH 22	DIN-Rail	ARM 0610		
DIN-Rail	ARH 2320	DIN-Rail	ARM 0615		
DIN-Rail	ARH 2328	DIN-Rail	ARM 0808		
DIN-Rail	ARH 2333	DIN-Rail	ARM 0813		

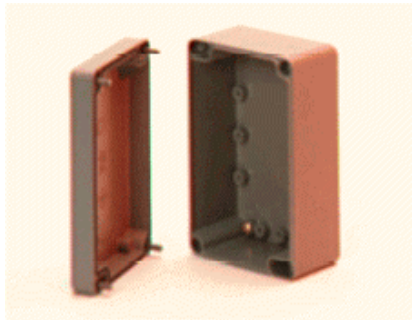

This is a sample photo.

**ORDER SYMBOL:** AL 061005

**EL.number** **EAN:** 6418074004093  
 Sweden: 2536307  
 Denmark: 8212004621  
 Finland: 3423605

**INCLUDING:**  
 Enclosure body, cover with PUR gasket, cover screws, and 2 earth screws.

**APPROVALS:**  
 USA: UL Type 1, 4, 4X, 12, 13 (E75645 Vol.1 Sec.6)  
 EURO: IP 67/IP 66  
 OTHERS: IEC 529

FIBOX EURONORM II AL

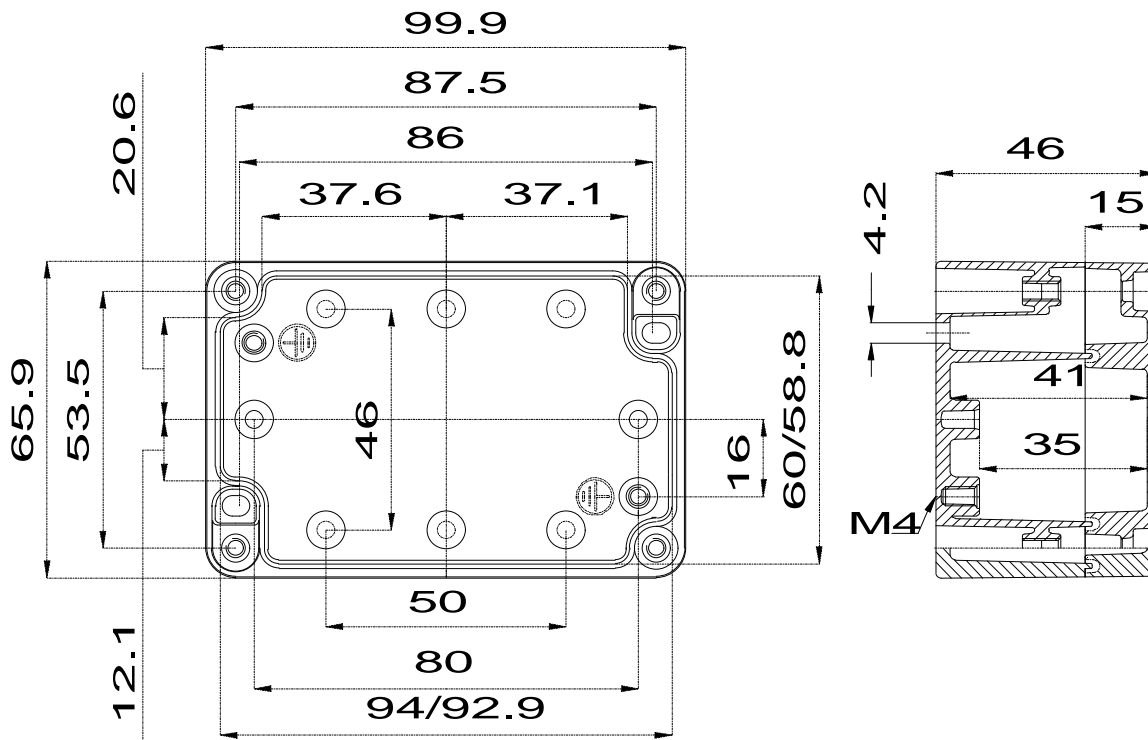

**TECHNICAL INFORMATION:**

Standard colour: RAL 7001  
 Ingress protection: IP 67 (IEC 529)  
 Flame resistance:

Temp.range in cont. use: Max. +80 °C  
 Temp. range of material: - 50 °C - + 120 °C

**ACCESSORIES**

DIN-Rail	ARH 12	DIN-Rail	ARH 26	DIN-Rail	ARM 0818
DIN-Rail	ARH 16	DIN-Rail	ARH 36	DIN-Rail	ARM 0825
DIN-Rail	ARH 1636	DIN-Rail	ARH 40	Fastening lug	MRS 28540
DIN-Rail	ARH 1656	DIN-Rail	ARH 60	Fastening lug	MRS 28541
DIN-Rail	ARH 22	DIN-Rail	ARM 0610		
DIN-Rail	ARH 2320	DIN-Rail	ARM 0615		
DIN-Rail	ARH 2328	DIN-Rail	ARM 0808		
DIN-Rail	ARH 2333	DIN-Rail	ARM 0813		

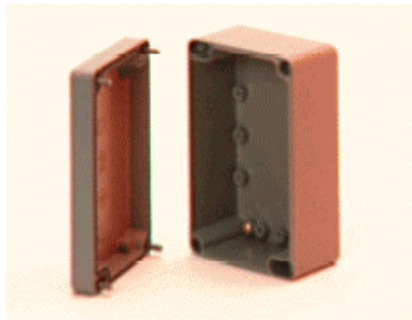

This is a sample photo.

**ORDER SYMBOL:** AL 061505

**EL.number** **EAN:** 6418074004109  
 Sweden: 2536309  
 Denmark: 8212004634  
 Finland: 3423607

**INCLUDING:**  
 Enclosure body, cover with PUR gasket, cover screws, and 2 earth screws.

**APPROVALS:**  
 USA: UL Type 1, 4, 4X, 12, 13 (E75645 Vol.1 Sec.6)  
 EURO: IP 67/IP 66  
 OTHERS: IEC 529

FIBOX EURONORM II AL

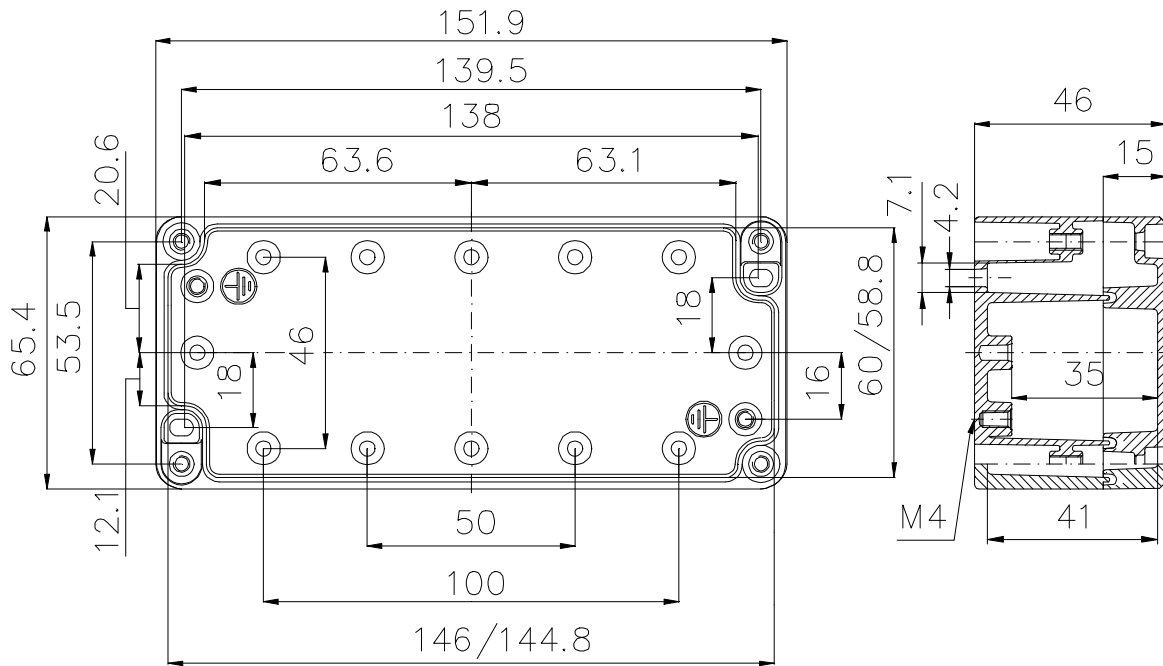

**TECHNICAL INFORMATION:**

Standard colour: RAL 7001  
 Ingress protection: IP 67 (IEC 529)  
 Flame resistance:

Temp.range in cont. use: Max. +80 °C  
 Temp. range of material: - 50 °C - + 120 °C

**ACCESSORIES**

DIN-Rail	ARH 12	DIN-Rail	ARH 26	DIN-Rail	ARM 0818
DIN-Rail	ARH 16	DIN-Rail	ARH 36	DIN-Rail	ARM 0825
DIN-Rail	ARH 1636	DIN-Rail	ARH 40	Fastening lug	MRS 28540
DIN-Rail	ARH 1656	DIN-Rail	ARH 60	Fastening lug	MRS 28541
DIN-Rail	ARH 22	DIN-Rail	ARM 0610		
DIN-Rail	ARH 2320	DIN-Rail	ARM 0615		
DIN-Rail	ARH 2328	DIN-Rail	ARM 0808		
DIN-Rail	ARH 2333	DIN-Rail	ARM 0813		



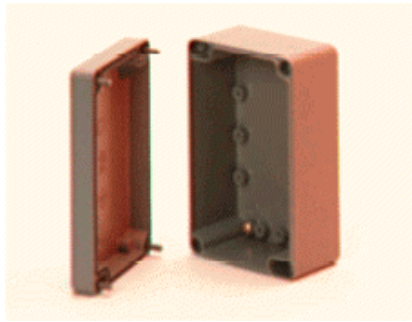

This is a sample photo.

**ORDER SYMBOL:** AL 080806

**EL.number** **EAN:** 6418074004116  
 Sweden: 2536311  
 Denmark: 8212004647  
 Finland: 3423609

**INCLUDING:**  
 Enclosure body, cover with PUR gasket, cover screws, 4 mounting screws and 2 earth screws.

**APPROVALS:**  
 USA: UL Type 1, 4, 4X, 12, 13 (E75645 Vol.1 Sec.6)  
 EURO: IP 67/IP 66  
 OTHERS: IEC 529

**FIBOX EURONORM II AL**

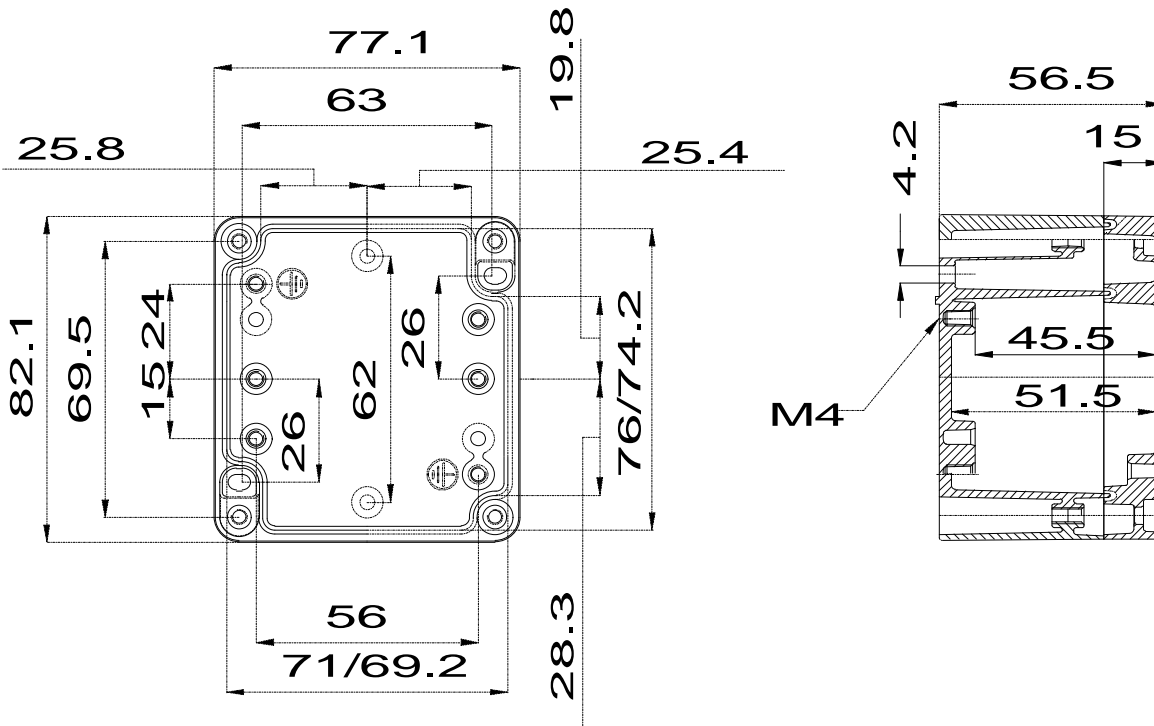

**TECHNICAL INFORMATION:**

Standard colour: RAL 7001  
 Ingress protection: IP 67 (IEC 529)  
 Flame resistance:

Temp.range in cont. use: Max. +80 °C  
 Temp. range of material: - 50 °C - + 120 °C

**ACCESSORIES**

DIN-Rail	ARH 12	DIN-Rail	ARH 26	DIN-Rail	ARM 0818
DIN-Rail	ARH 16	DIN-Rail	ARH 36	DIN-Rail	ARM 0825
DIN-Rail	ARH 1636	DIN-Rail	ARH 40	Fastening lug	MRS 28540
DIN-Rail	ARH 1656	DIN-Rail	ARH 60	Fastening lug	MRS 28541
DIN-Rail	ARH 22	DIN-Rail	ARM 0610		
DIN-Rail	ARH 2320	DIN-Rail	ARM 0615		
DIN-Rail	ARH 2328	DIN-Rail	ARM 0808		
DIN-Rail	ARH 2333	DIN-Rail	ARM 0813		

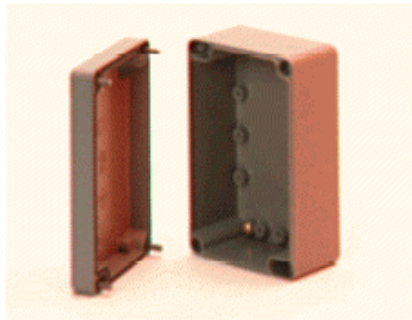

This is a sample photo.

**ORDER SYMBOL:** AL 081306

**EL.number** **EAN:** 6418074004123  
 Sweden: 2536313  
 Denmark: 8212004650  
 Finland: 3423611

**INCLUDING:**  
 Enclosure body, cover with PUR gasket, cover screws, 4 mounting screws and 2 earth screws.

**APPROVALS:**  
 USA: UL Type 1, 4, 4X, 12, 13 (E75645 Vol.1 Sec.6)  
 EURO: IP 67/IP 66  
 OTHERS: IEC 529

**FIBOX EURONORM II AL**

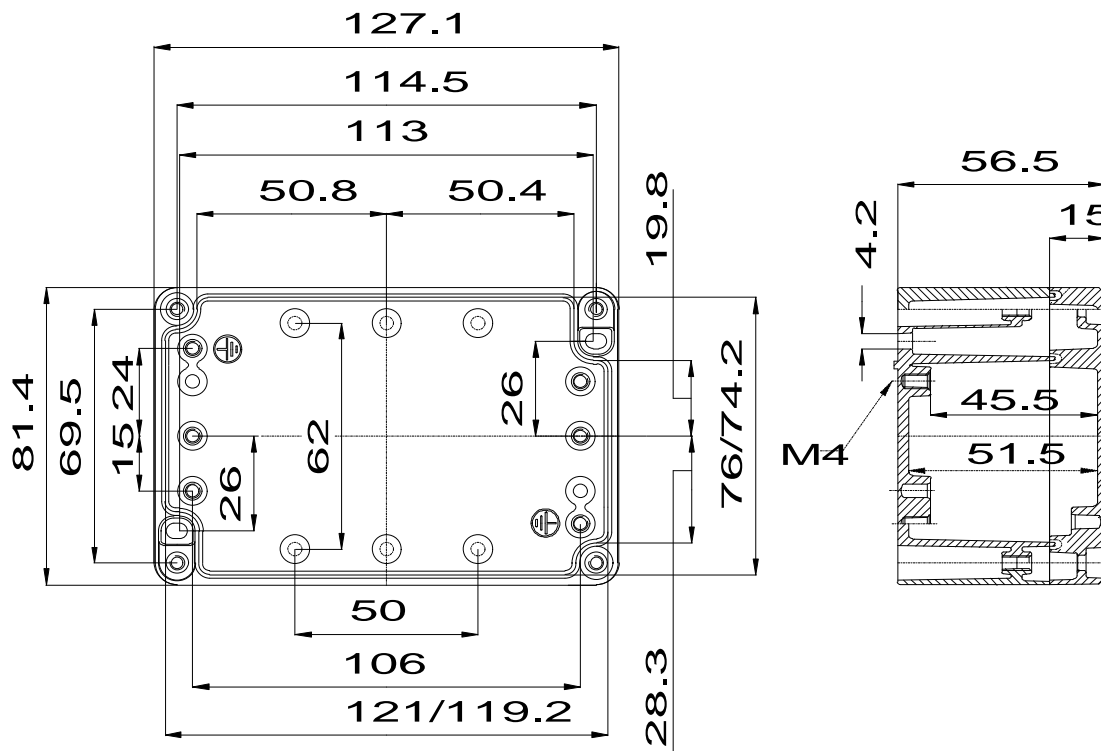

**TECHNICAL INFORMATION:**

Standard colour: RAL 7001  
 Ingress protection: IP 67 (IEC 529)  
 Flame resistance:

Temp.range in cont. use: Max. +80 °C  
 Temp. range of material: - 50 °C - + 120 °C

**ACCESSORIES**

DIN-Rail	ARH 12	DIN-Rail	ARH 26	DIN-Rail	ARM 0818
DIN-Rail	ARH 16	DIN-Rail	ARH 36	DIN-Rail	ARM 0825
DIN-Rail	ARH 1636	DIN-Rail	ARH 40	Fastening lug	MRS 28540
DIN-Rail	ARH 1656	DIN-Rail	ARH 60	Fastening lug	MRS 28541
DIN-Rail	ARH 22	DIN-Rail	ARM 0610		
DIN-Rail	ARH 2320	DIN-Rail	ARM 0615		
DIN-Rail	ARH 2328	DIN-Rail	ARM 0808		
DIN-Rail	ARH 2333	DIN-Rail	ARM 0813		

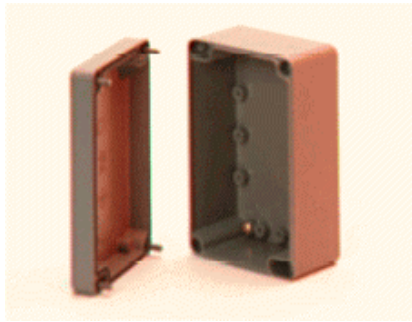

This is a sample photo.

**ORDER SYMBOL:** AL 081806

**EL.number** **EAN:** 6418074004130  
 Sweden: 2536315  
 Denmark: 8212004663  
 Finland: 3423613

**INCLUDING:**  
 Enclosure body, cover with PUR gasket, cover screws, 4 mounting screws and 2 earth screws.

**APPROVALS:**  
 USA: UL Type 1, 4, 4X, 12, 13 (E75645 Vol.1 Sec.6)  
 EURO: IP 67/IP 66  
 OTHERS: IEC 529

FIBOX EURONORM II AL

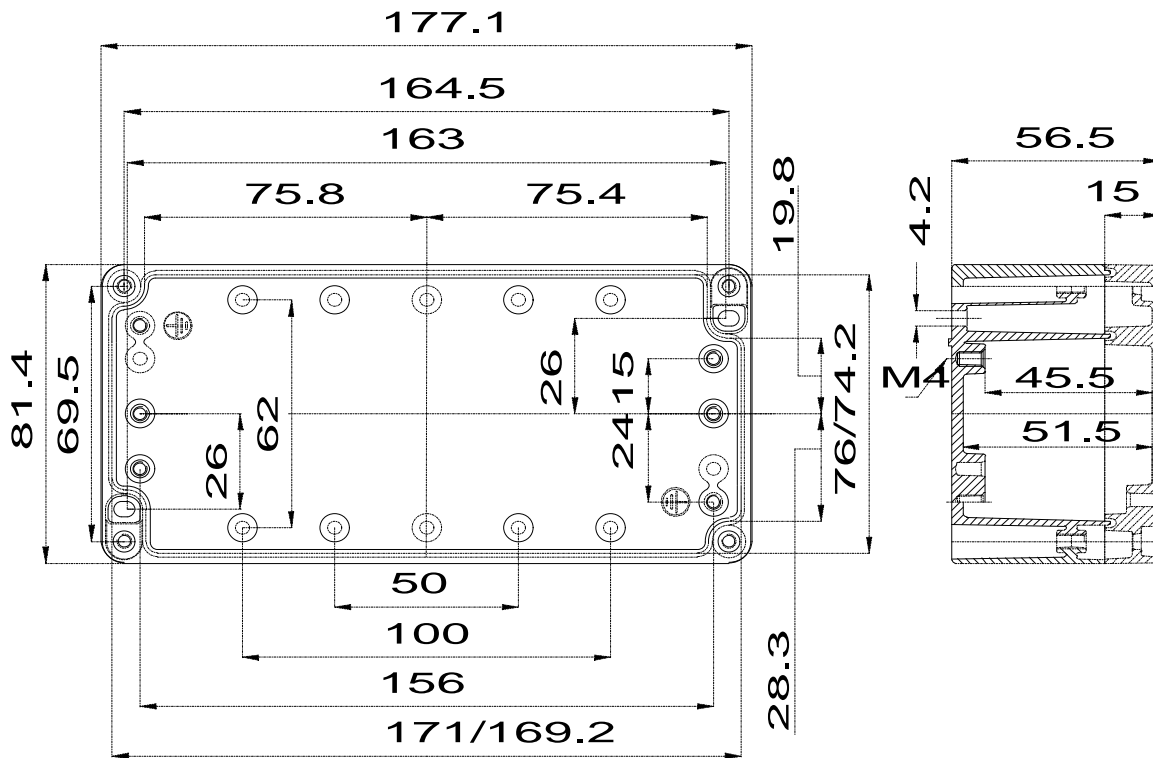

**TECHNICAL INFORMATION:**

Standard colour: RAL 7001  
 Ingress protection: IP 67 (IEC 529)  
 Flame resistance:

Temp.range in cont. use: Max. +80 °C  
 Temp. range of material: - 50 °C - + 120 °C

**ACCESSORIES**

DIN-Rail	ARH 12	DIN-Rail	ARH 26	DIN-Rail	ARM 0818
DIN-Rail	ARH 16	DIN-Rail	ARH 36	DIN-Rail	ARM 0825
DIN-Rail	ARH 1636	DIN-Rail	ARH 40	Fastening lug	MRS 28540
DIN-Rail	ARH 1656	DIN-Rail	ARH 60	Fastening lug	MRS 28541
DIN-Rail	ARH 22	DIN-Rail	ARM 0610		
DIN-Rail	ARH 2320	DIN-Rail	ARM 0615		
DIN-Rail	ARH 2328	DIN-Rail	ARM 0808		
DIN-Rail	ARH 2333	DIN-Rail	ARM 0813		

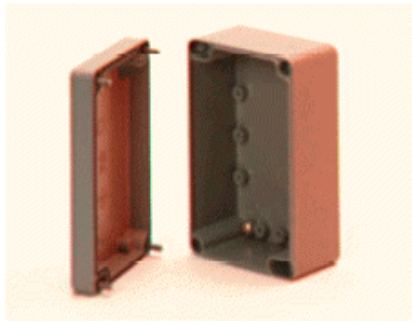

This is a sample photo.

**ORDER SYMBOL:** AL 082506

**EL.number** **EAN:** 6418074004147  
 Sweden: 2536317  
 Denmark: 8212004676  
 Finland: 3423615

**INCLUDING:**  
 Enclosure body, cover with PUR gasket, cover screws, 4 mounting screws and 2 earth screws.

**APPROVALS:**  
 USA: UL Type 1, 4, 4X, 12, 13 (E75645 Vol.1 Sec.6)  
 EURO: IP 67/IP 66  
 OTHERS: IEC 529

FIBOX EURONORM II AL

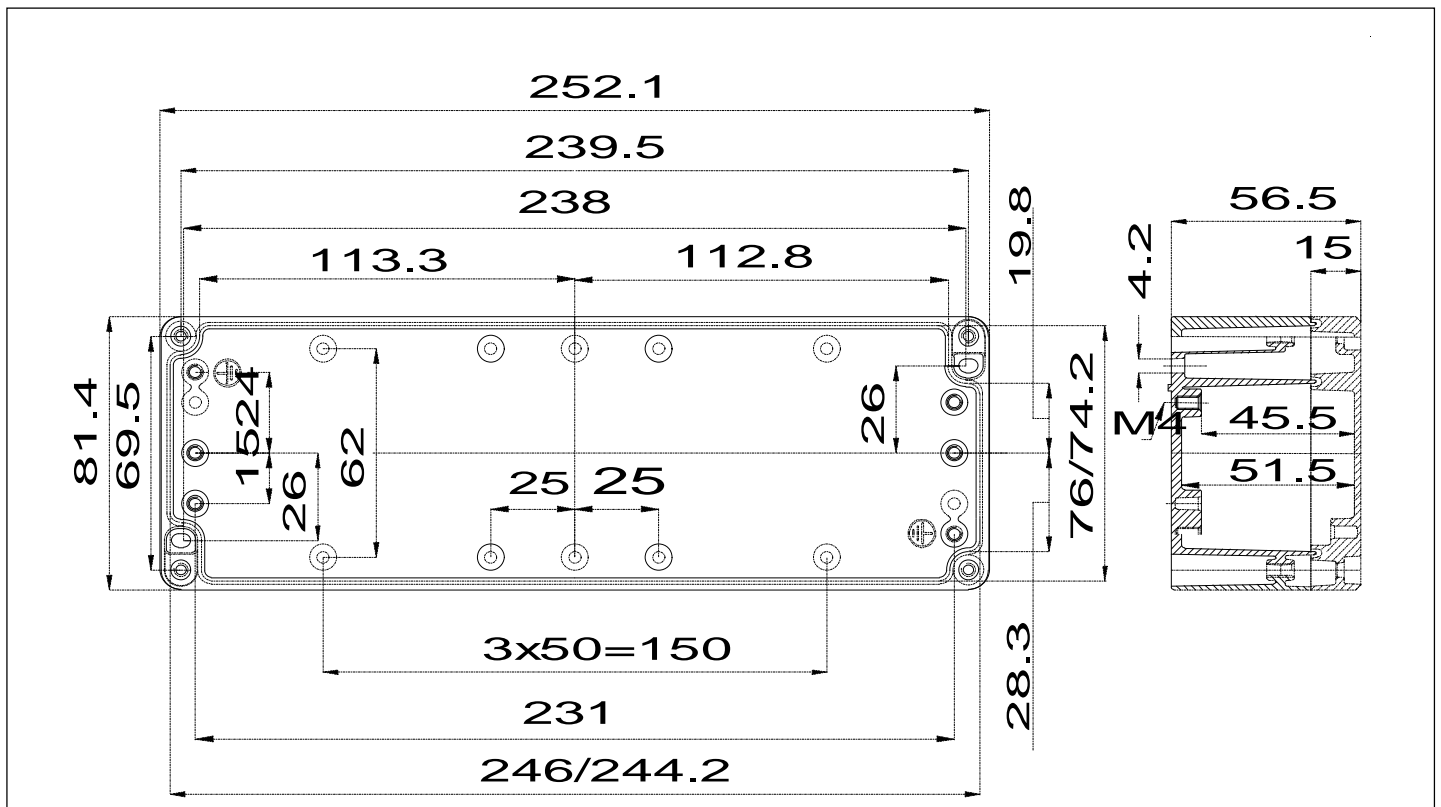

**TECHNICAL INFORMATION:**

Standard colour: RAL 7001  
 Ingress protection: IP 67 (IEC 529)  
 Flame resistance:

Temp.range in cont. use: Max. +80 °C  
 Temp. range of material: - 50 °C - + 120 °C

**ACCESSORIES**

DIN-Rail	ARH 12	DIN-Rail	ARH 26	DIN-Rail	ARM 0818
DIN-Rail	ARH 16	DIN-Rail	ARH 36	DIN-Rail	ARM 0825
DIN-Rail	ARH 1636	DIN-Rail	ARH 40	Fastening lug	MRS 28540
DIN-Rail	ARH 1656	DIN-Rail	ARH 60	Fastening lug	MRS 28541
DIN-Rail	ARH 22	DIN-Rail	ARM 0610		
DIN-Rail	ARH 2320	DIN-Rail	ARM 0615		
DIN-Rail	ARH 2328	DIN-Rail	ARM 0808		
DIN-Rail	ARH 2333	DIN-Rail	ARM 0813		

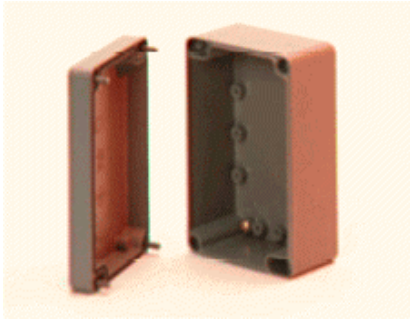

This is a sample photo.

**ORDER SYMBOL:** AL 121208

**EL.number** **EAN:** 6418074004154  
 Sweden: 2536319  
 Denmark: 8212004689  
 Finland: 3423617

**INCLUDING:**  
 Enclosure body, cover with PUR gasket, cover screws, 4 mounting screws and 2 earth screws.

**APPROVALS:**  
 USA: UL Type 1, 4, 4X, 12, 13 (E75645 Vol.1 Sec.6)  
 EURO: IP 67/IP 66  
 OTHERS: IEC 529

FIBOX EURONORM II AL

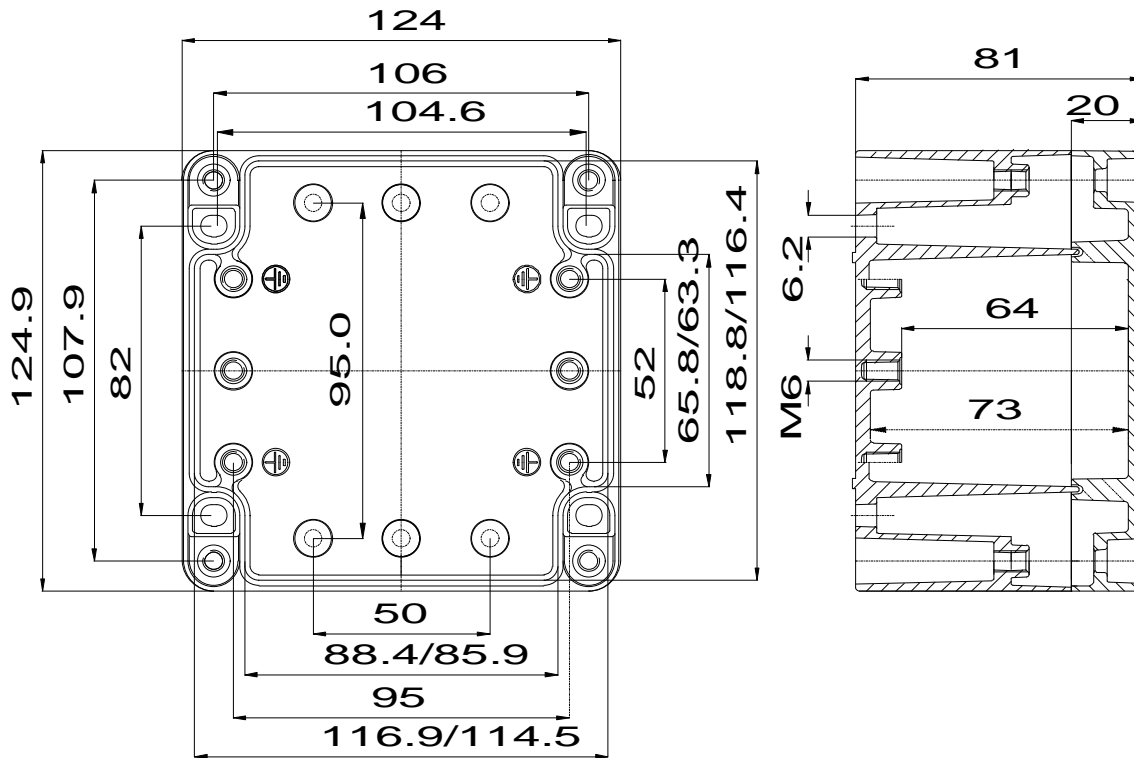

**TECHNICAL INFORMATION:**

Standard colour: RAL 7001  
 Ingress protection: IP 67 (IEC 529)  
 Flame resistance:

Temp.range in cont. use: Max. +80 °C  
 Temp. range of material: - 50 °C - + 120 °C

**ACCESSORIES**

DIN-Rail	ARH 12	DIN-Rail	ARH 26	DIN-Rail	ARM 0818
DIN-Rail	ARH 16	DIN-Rail	ARH 36	DIN-Rail	ARM 0825
DIN-Rail	ARH 1636	DIN-Rail	ARH 40	Fastening lug	MRS 28540
DIN-Rail	ARH 1656	DIN-Rail	ARH 60	Fastening lug	MRS 28541
DIN-Rail	ARH 22	DIN-Rail	ARM 0610		
DIN-Rail	ARH 2320	DIN-Rail	ARM 0615		
DIN-Rail	ARH 2328	DIN-Rail	ARM 0808		
DIN-Rail	ARH 2333	DIN-Rail	ARM 0813		

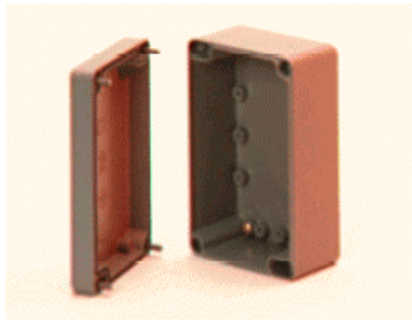

This is a sample photo.

**ORDER SYMBOL:** AL 122208

**EL.number** **EAN:** 6418074004161  
 Sweden: 2536321  
 Denmark: 8212004702  
 Finland: 3423619

**INCLUDING:**  
 Enclosure body, cover with PUR gasket, cover screws, 4 mounting screws and 2 earth screws.

**APPROVALS:**  
 USA: UL Type 1, 4, 4X, 12, 13 (E75645 Vol.1 Sec.6)  
 EURO: IP 67/IP 66  
 OTHERS: IEC 529

**FIBOX EURONORM II AL**

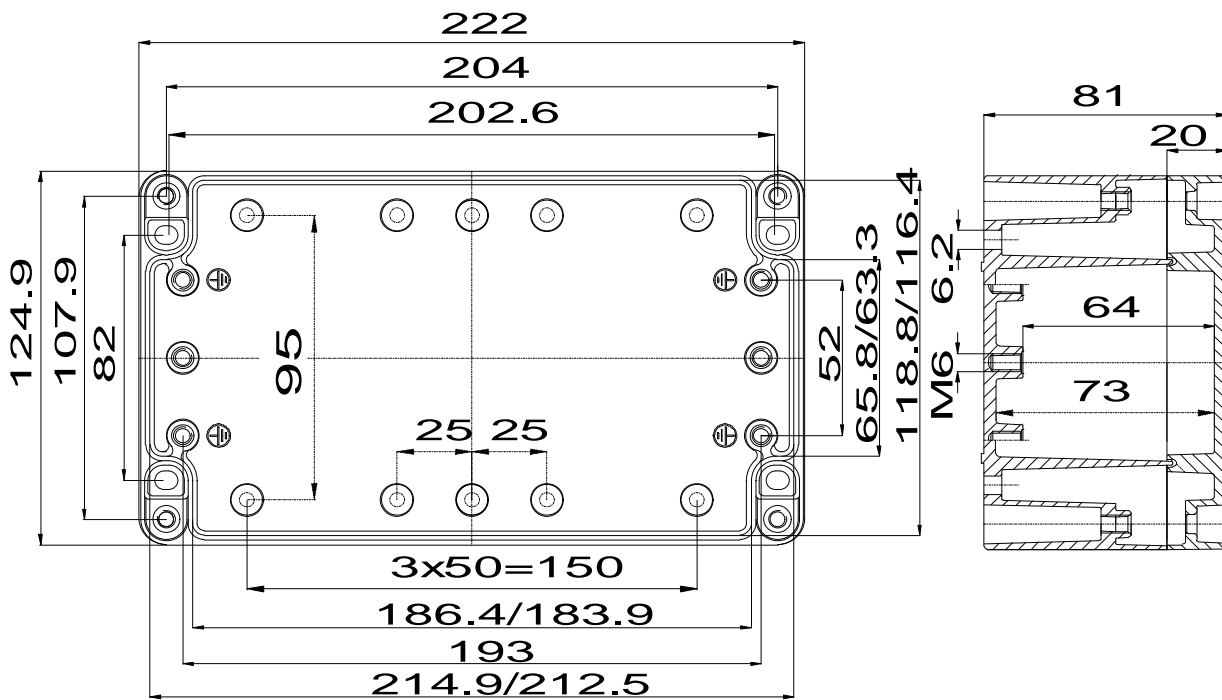

**TECHNICAL INFORMATION:**

Standard colour: RAL 7001  
 Ingress protection: IP 67 (IEC 529)  
 Flame resistance:

Temp.range in cont. use: Max. +80 °C  
 Temp. range of material: - 50 °C - + 120 °C

**ACCESSORIES**

DIN-Rail	ARH 12	DIN-Rail	ARH 26	DIN-Rail	ARM 0818
DIN-Rail	ARH 16	DIN-Rail	ARH 36	DIN-Rail	ARM 0825
DIN-Rail	ARH 1636	DIN-Rail	ARH 40	Fastening lug	MRS 28540
DIN-Rail	ARH 1656	DIN-Rail	ARH 60	Fastening lug	MRS 28541
DIN-Rail	ARH 22	DIN-Rail	ARM 0610		
DIN-Rail	ARH 2320	DIN-Rail	ARM 0615		
DIN-Rail	ARH 2328	DIN-Rail	ARM 0808		
DIN-Rail	ARH 2333	DIN-Rail	ARM 0813		

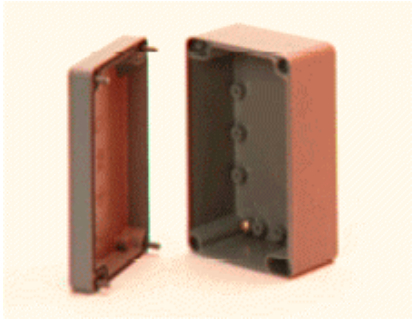

This is a sample photo.

**ORDER SYMBOL:** AL 123608

**EL.number** **EAN:** 6418074004178  
 Sweden: 2536323  
 Denmark: 8212004728  
 Finland: 3423621

**INCLUDING:**  
 Enclosure body, cover with PUR gasket, cover screws, 4 mounting screws and 2 earth screws.

**APPROVALS:**  
 USA: UL Type 1, 4, 4X, 12, 13 (E75645 Vol.1 Sec.6)  
 EURO: IP 67/IP 66  
 OTHERS: IEC 529

FIBOX EURONORM II AL

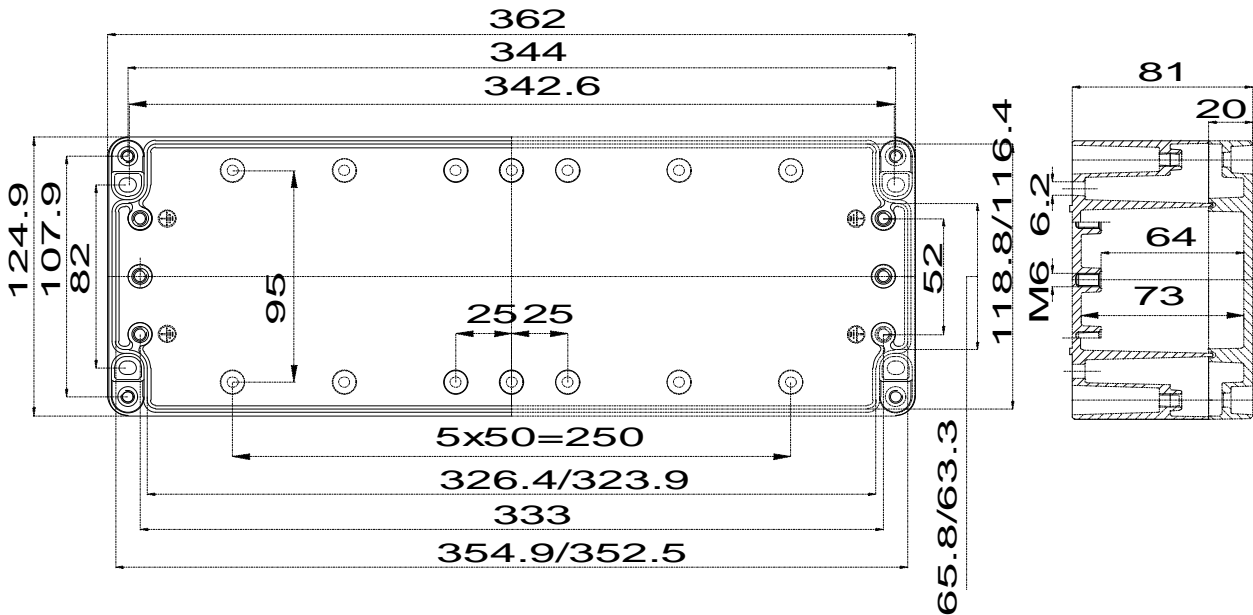

**TECHNICAL INFORMATION:**

Standard colour: RAL 7001  
 Ingress protection: IP 67 (IEC 529)  
 Flame resistance:

Temp.range in cont. use: Max. +80 °C  
 Temp. range of material: - 50 °C - + 120 °C

**ACCESSORIES**

DIN-Rail	ARH 12	DIN-Rail	ARH 26	DIN-Rail	ARM 0818
DIN-Rail	ARH 16	DIN-Rail	ARH 36	DIN-Rail	ARM 0825
DIN-Rail	ARH 1636	DIN-Rail	ARH 40	Fastening lug	MRS 28540
DIN-Rail	ARH 1656	DIN-Rail	ARH 60	Fastening lug	MRS 28541
DIN-Rail	ARH 22	DIN-Rail	ARM 0610		
DIN-Rail	ARH 2320	DIN-Rail	ARM 0615		
DIN-Rail	ARH 2328	DIN-Rail	ARM 0808		
DIN-Rail	ARH 2333	DIN-Rail	ARM 0813		

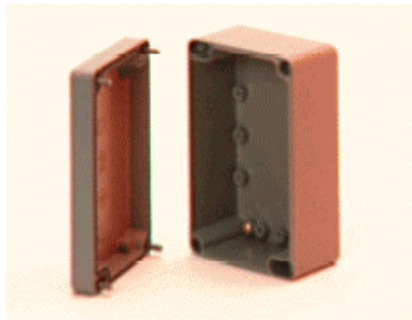

This is a sample photo.

**ORDER SYMBOL:** AL 161609

**EL.number** **EAN:** 6418074004185  
 Sweden: 2536325  
 Denmark: 8212004731  
 Finland: 3423623

**INCLUDING:**  
 Enclosure body, cover with PUR gasket, cover screws, 4 mounting screws and 2 earth screws.

**APPROVALS:**  
 USA: UL Type 1, 4, 4X, 12, 13 (E75645 Vol.1 Sec.6)  
 EURO: IP 67/IP 66  
 OTHERS: IEC 529

FIBOX EURONORM II AL

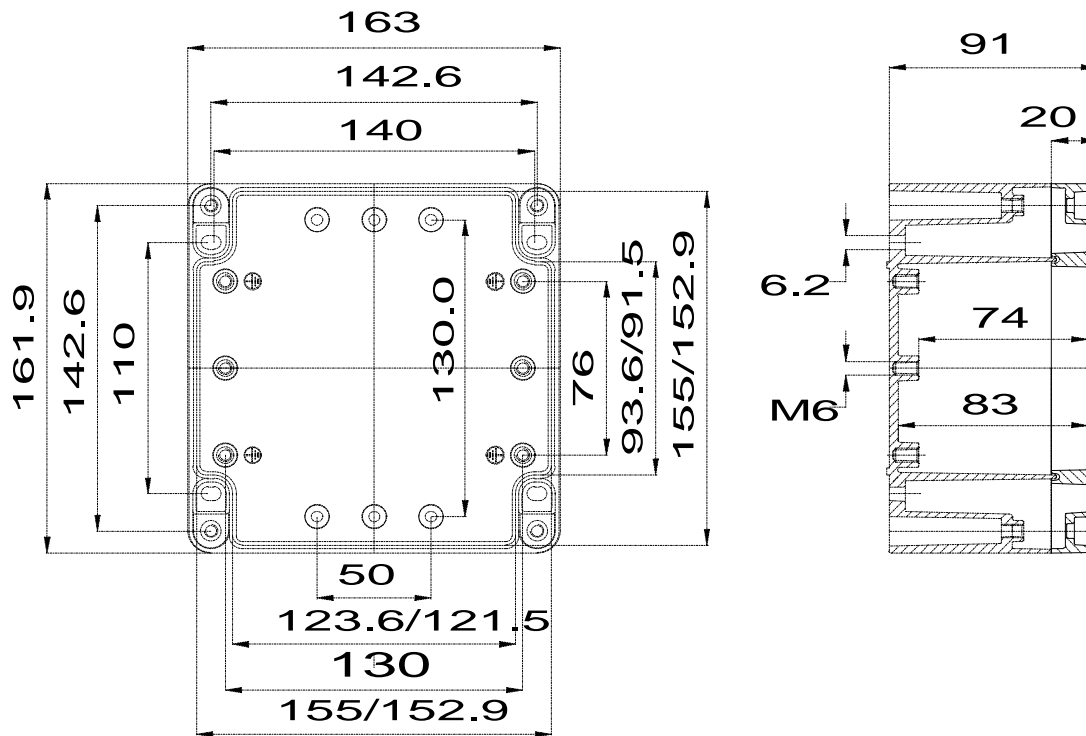

**TECHNICAL INFORMATION:**

Standard colour: RAL 7001  
 Ingress protection: IP 67 (IEC 529)  
 Flame resistance:

Temp.range in cont. use: Max. +80 °C  
 Temp. range of material: - 50 °C - + 120 °C

**ACCESSORIES**

DIN-Rail	ARH 12	DIN-Rail	ARH 26	DIN-Rail	ARM 0818
DIN-Rail	ARH 16	DIN-Rail	ARH 36	DIN-Rail	ARM 0825
DIN-Rail	ARH 1636	DIN-Rail	ARH 40	Fastening lug	MRS 28540
DIN-Rail	ARH 1656	DIN-Rail	ARH 60	Fastening lug	MRS 28541
DIN-Rail	ARH 22	DIN-Rail	ARM 0610		
DIN-Rail	ARH 2320	DIN-Rail	ARM 0615		
DIN-Rail	ARH 2328	DIN-Rail	ARM 0808		
DIN-Rail	ARH 2333	DIN-Rail	ARM 0813		



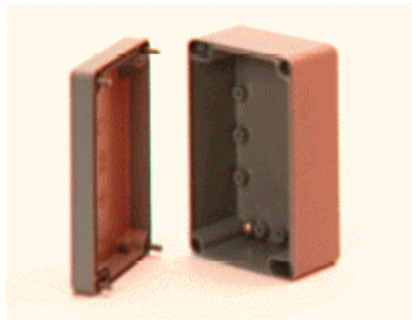

This is a sample photo.

**ORDER SYMBOL:** AL 162609

**EL.number** **EAN:** 6418074004192  
 Sweden: 2536327  
 Denmark: 8212004744  
 Finland: 3423625

**INCLUDING:**  
 Enclosure body, cover with PUR gasket, cover screws, 4 mounting screws and 2 earth screws.

**APPROVALS:**  
 USA: UL Type 1, 4, 4X, 12, 13 (E75645 Vol.1 Sec.6)  
 EURO: IP 67/IP 66  
 OTHERS: IEC 529

FIBOX EURONORM II AL

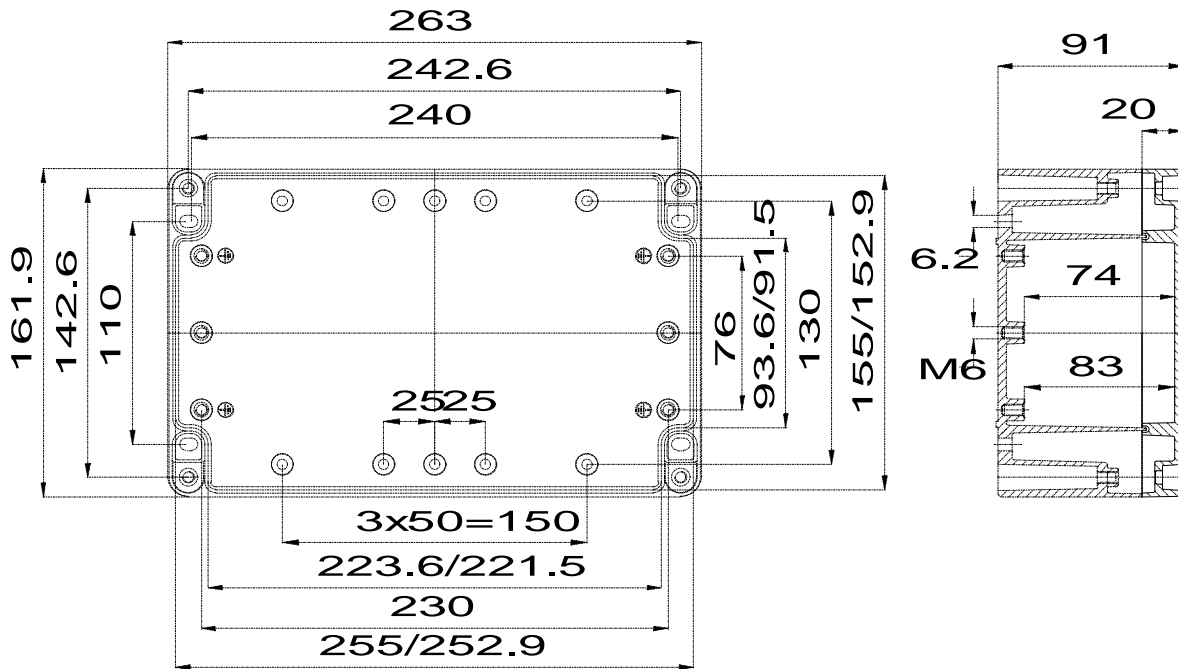

**TECHNICAL INFORMATION:**

Standard colour: RAL 7001  
 Ingress protection: IP 67 (IEC 529)  
 Flame resistance:

Temp.range in cont. use: Max. +80 °C  
 Temp. range of material: - 50 °C - + 120 °C

**ACCESSORIES**

DIN-Rail	ARH 12	DIN-Rail	ARH 26	DIN-Rail	ARM 0818
DIN-Rail	ARH 16	DIN-Rail	ARH 36	DIN-Rail	ARM 0825
DIN-Rail	ARH 1636	DIN-Rail	ARH 40	Fastening lug	MRS 28540
DIN-Rail	ARH 1656	DIN-Rail	ARH 60	Fastening lug	MRS 28541
DIN-Rail	ARH 22	DIN-Rail	ARM 0610		
DIN-Rail	ARH 2320	DIN-Rail	ARM 0615		
DIN-Rail	ARH 2328	DIN-Rail	ARM 0808		
DIN-Rail	ARH 2333	DIN-Rail	ARM 0813		

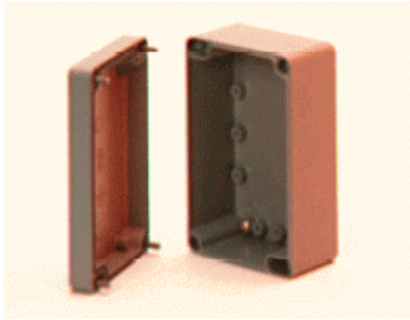

This is a sample photo.

**ORDER SYMBOL:** AL 163609

**EL.number** **EAN:** 6418074004208  
 Sweden: 2536329  
 Denmark: 8212004757  
 Finland: 3423627

**INCLUDING:**  
 Enclosure body, cover with PUR gasket, cover screws, 4 mounting screws and 2 earth screws.

**APPROVALS:**  
 USA: UL Type 1, 4, 4X, 12, 13 (E75645 Vol.1 Sec.6)  
 EURO: IP 67/IP 66  
 OTHERS: IEC 529

**FIBOX EURONORM II AL**

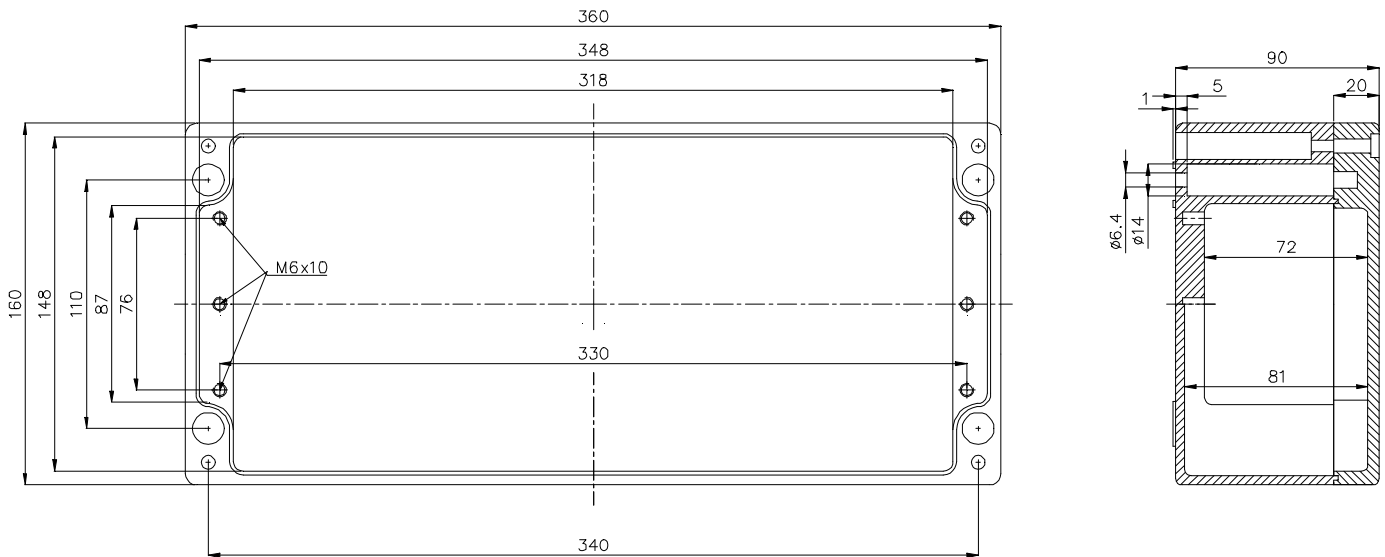

**TECHNICAL INFORMATION:**

Standard colour: RAL 7001  
 Ingress protection: IP 67 (IEC 529)  
 Flame resistance:

Temp.range in cont. use: Max. +80 °C  
 Temp. range of material: - 50 °C - + 120 °C

**ACCESSORIES**

DIN-Rail	ARH 12	DIN-Rail	ARH 26	DIN-Rail	ARM 0818
DIN-Rail	ARH 16	DIN-Rail	ARH 36	DIN-Rail	ARM 0825
DIN-Rail	ARH 1636	DIN-Rail	ARH 40	Fastening lug	MRS 28540
DIN-Rail	ARH 1656	DIN-Rail	ARH 60	Fastening lug	MRS 28541
DIN-Rail	ARH 22	DIN-Rail	ARM 0610		
DIN-Rail	ARH 2320	DIN-Rail	ARM 0615		
DIN-Rail	ARH 2328	DIN-Rail	ARM 0808		
DIN-Rail	ARH 2333	DIN-Rail	ARM 0813		

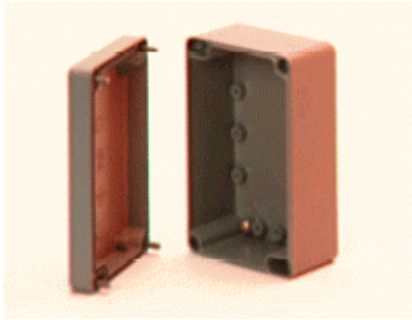

This is a sample photo.

**ORDER SYMBOL:** AL 165609

**EL.number** **EAN:** 6418074004215  
 Sweden: 2536331  
 Denmark: 8212004760  
 Finland: 3423629

**INCLUDING:**  
 Enclosure body, cover with PUR gasket, cover screws, 4 mounting screws and 2 earth screws.

**APPROVALS:**  
 USA: UL Type 1, 4, 4X, 12, 13 (E75645 Vol.1 Sec.6)  
 EURO: IP 67/IP 66  
 OTHERS: IEC 529

**FIBOX EURONORM II AL**

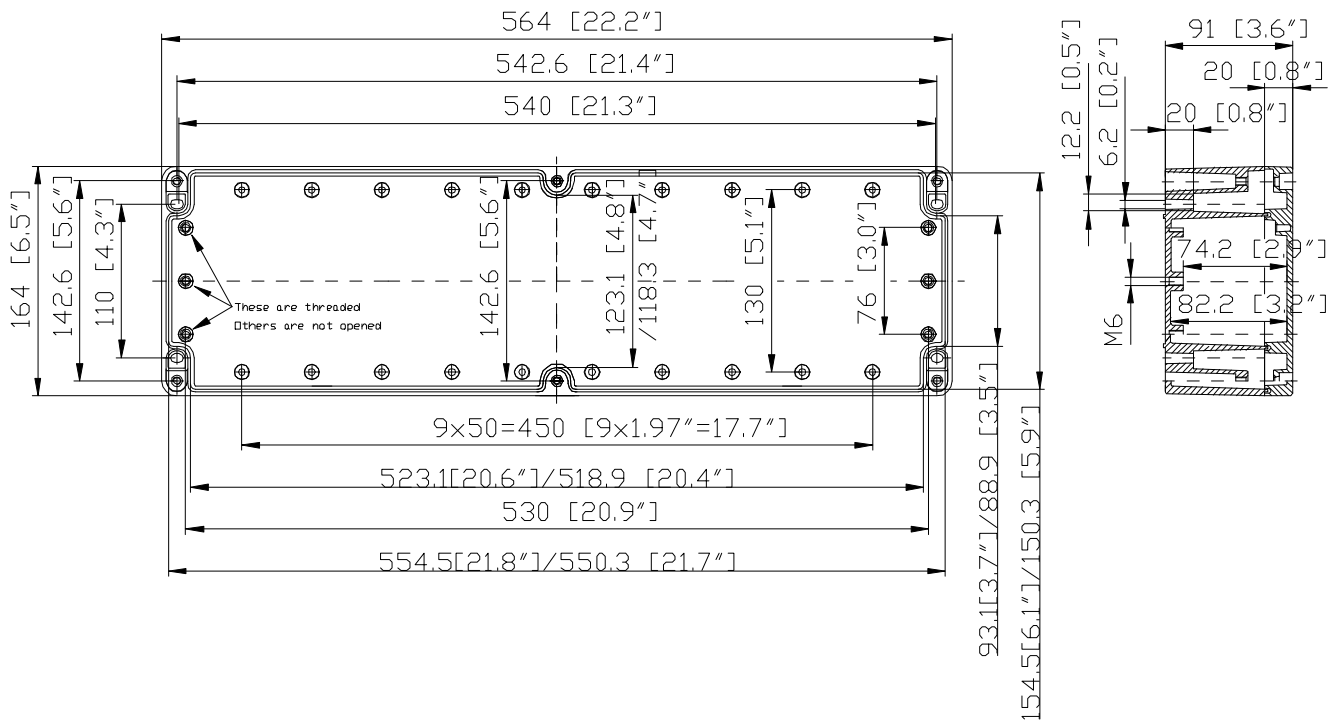

**TECHNICAL INFORMATION:**

Standard colour: RAL 7001  
 Ingress protection: IP 67 (IEC 529)  
 Flame resistance:

Temp.range in cont. use: Max. +80 °C  
 Temp. range of material: - 50 °C - + 120 °C

**ACCESSORIES**

DIN-Rail	ARH 12	DIN-Rail	ARH 26	DIN-Rail	ARM 0818
DIN-Rail	ARH 16	DIN-Rail	ARH 36	DIN-Rail	ARM 0825
DIN-Rail	ARH 1636	DIN-Rail	ARH 40	Fastening lug	MRS 28540
DIN-Rail	ARH 1656	DIN-Rail	ARH 60	Fastening lug	MRS 28541
DIN-Rail	ARH 22	DIN-Rail	ARM 0610		
DIN-Rail	ARH 2320	DIN-Rail	ARM 0615		
DIN-Rail	ARH 2328	DIN-Rail	ARM 0808		
DIN-Rail	ARH 2333	DIN-Rail	ARM 0813		

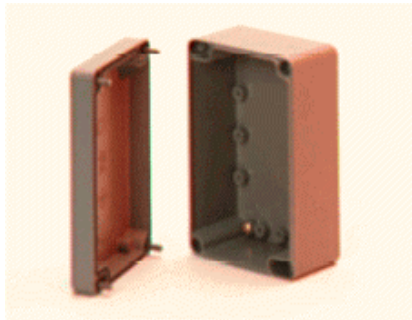

This is a sample photo.

**ORDER SYMBOL:** AL 232011

**EL.number** **EAN:** 6418074004222  
 Sweden: 2536333  
 Denmark: 8212004786  
 Finland: 3423631

**INCLUDING:**  
 Enclosure body, cover with PUR gasket, cover screws, 4 mounting screws and 2 earth screws.

**APPROVALS:**  
 USA: UL Type 1, 4, 4X, 12, 13 (E75645 Vol.1 Sec.6)  
 EURO: IP 67/IP 66  
 OTHERS: IEC 529

**FIBOX EURONORM II AL**

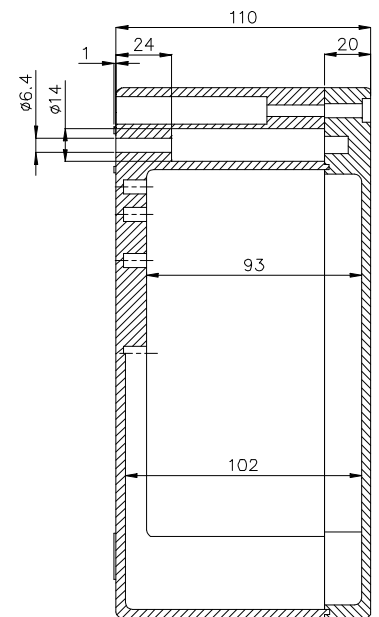
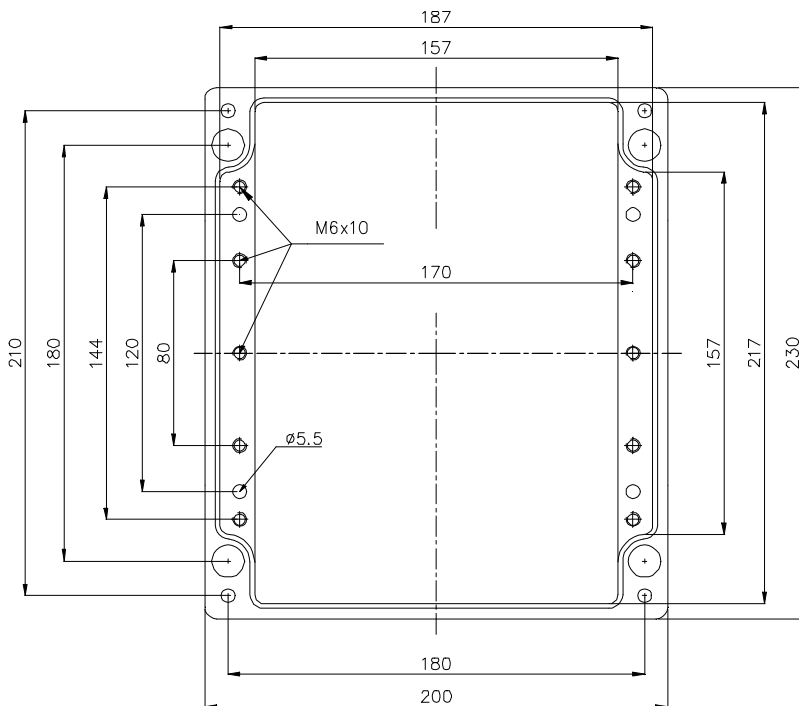

**TECHNICAL INFORMATION:**

Standard colour: RAL 7001  
 Ingress protection: IP 67 (IEC 529)  
 Flame resistance:

Temp.range in cont. use: Max. +80 °C  
 Temp. range of material: - 50 °C - + 120 °C

**ACCESSORIES**

DIN-Rail	ARH 12	DIN-Rail	ARH 26	DIN-Rail	ARM 0818
DIN-Rail	ARH 16	DIN-Rail	ARH 36	DIN-Rail	ARM 0825
DIN-Rail	ARH 1636	DIN-Rail	ARH 40	Fastening lug	MRS 28540
DIN-Rail	ARH 1656	DIN-Rail	ARH 60	Fastening lug	MRS 28541
DIN-Rail	ARH 22	DIN-Rail	ARM 0610		
DIN-Rail	ARH 2320	DIN-Rail	ARM 0615		
DIN-Rail	ARH 2328	DIN-Rail	ARM 0808		
DIN-Rail	ARH 2333	DIN-Rail	ARM 0813		

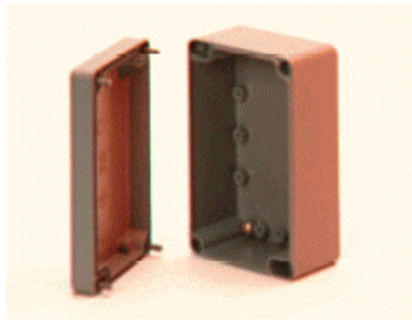

This is a sample photo.

**ORDER SYMBOL:** AL 232018

**EL.number** **EAN:** 6418074004239  
 Sweden: 2536335  
 Denmark: 8212004799  
 Finland: 3423633

**INCLUDING:**  
 Enclosure body, cover with Neoprene gasket, cover screws, and earth screws.

**APPROVALS:**  
 USA: UL Type 1, 4, 4X, 12, 13 (E75645 Vol.1 Sec.6)  
 EURO: IP 67/IP 66  
 OTHERS: IEC 529

**FIBOX EURONORM II AL**

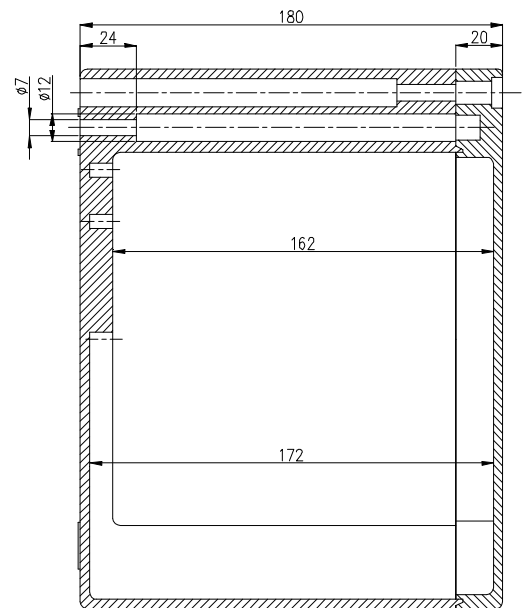
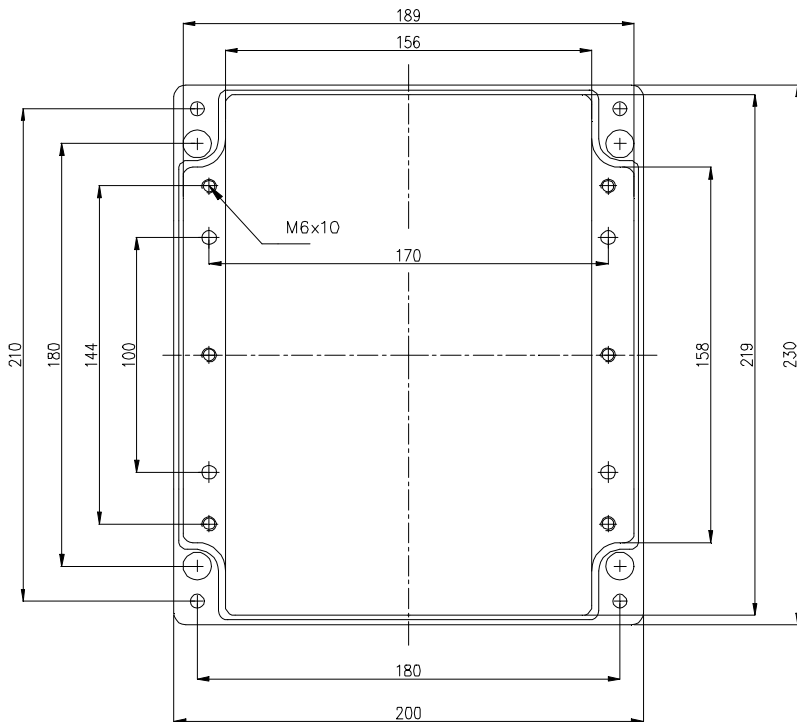

**TECHNICAL INFORMATION:**

Standard colour: RAL 7001  
 Ingress protection: IP 67 (IEC 529)  
 Flame resistance:

Temp.range in cont. use: Max. +80 °C  
 Temp. range of material: - 50 °C - + 120 °C

**ACCESSORIES**

DIN-Rail	ARH 12	DIN-Rail	ARH 26	DIN-Rail	ARM 0818
DIN-Rail	ARH 16	DIN-Rail	ARH 36	DIN-Rail	ARM 0825
DIN-Rail	ARH 1636	DIN-Rail	ARH 40	Fastening lug	MRS 28540
DIN-Rail	ARH 1656	DIN-Rail	ARH 60	Fastening lug	MRS 28541
DIN-Rail	ARH 22	DIN-Rail	ARM 0610		
DIN-Rail	ARH 2320	DIN-Rail	ARM 0615		
DIN-Rail	ARH 2328	DIN-Rail	ARM 0808		
DIN-Rail	ARH 2333	DIN-Rail	ARM 0813		

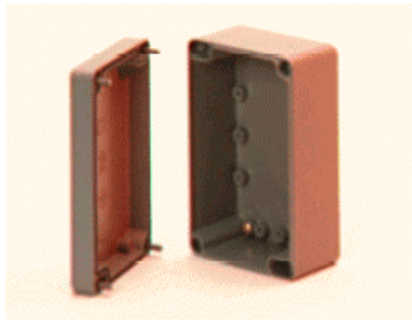

This is a sample photo.

**ORDER SYMBOL:** AL 232811

**EL.number** **EAN:** 6418074004246  
 Sweden: 2536337  
 Denmark: 8212004809  
 Finland: 3423635

**INCLUDING:**  
 Enclosure body, cover with PUR gasket, cover screws, 4 mounting screws and 2 earth screws.

**APPROVALS:**  
 USA: UL Type 1, 4, 4X, 12, 13 (E75645 Vol.1 Sec.6)  
 EURO: IP 67/IP 66  
 OTHERS: IEC 529

**FIBOX EURONORM II AL**

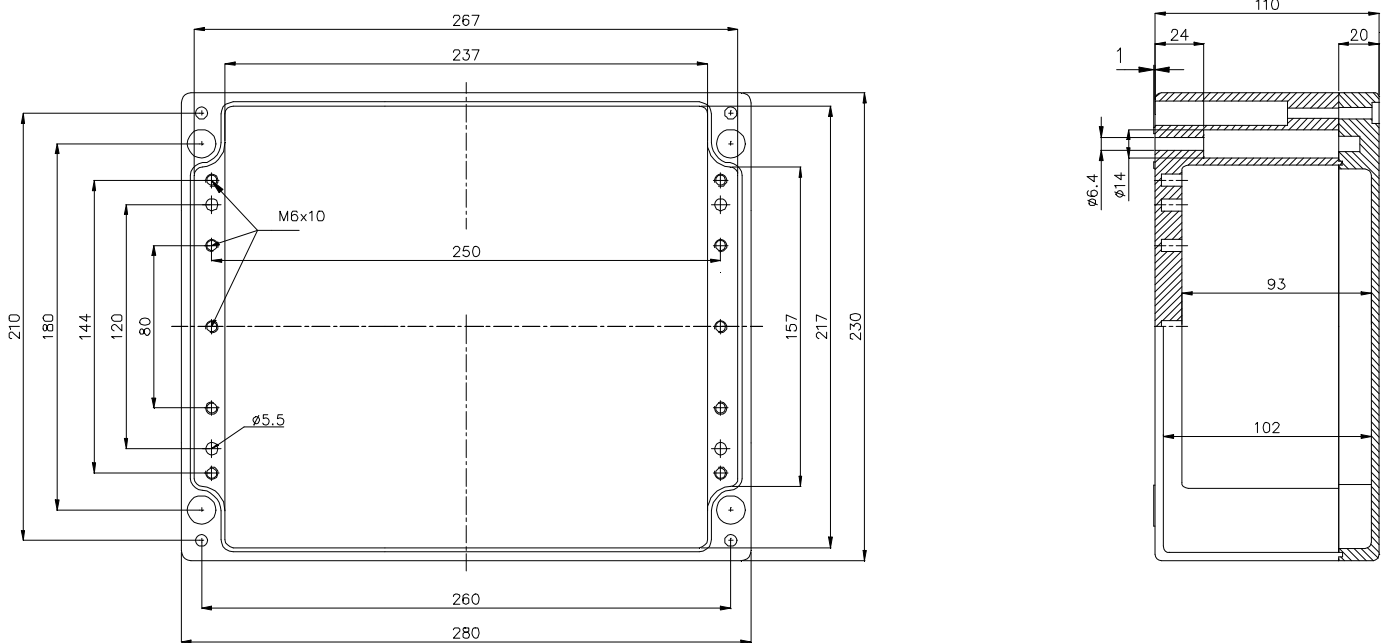

**TECHNICAL INFORMATION:**

Standard colour: RAL 7001  
 Ingress protection: IP 67 (IEC 529)  
 Flame resistance:

Temp.range in cont. use: Max. +80 °C  
 Temp. range of material: - 50 °C - + 120 °C

**ACCESSORIES**

DIN-Rail	ARH 12	DIN-Rail	ARH 26	DIN-Rail	ARM 0818
DIN-Rail	ARH 16	DIN-Rail	ARH 36	DIN-Rail	ARM 0825
DIN-Rail	ARH 1636	DIN-Rail	ARH 40	Fastening lug	MRS 28540
DIN-Rail	ARH 1656	DIN-Rail	ARH 60	Fastening lug	MRS 28541
DIN-Rail	ARH 22	DIN-Rail	ARM 0610		
DIN-Rail	ARH 2320	DIN-Rail	ARM 0615		
DIN-Rail	ARH 2328	DIN-Rail	ARM 0808		
DIN-Rail	ARH 2333	DIN-Rail	ARM 0813		