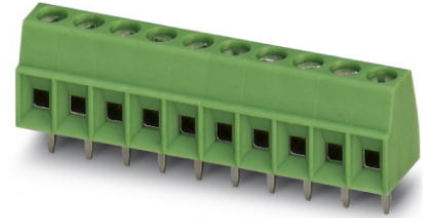

MKDS 1/12-3,5

Order No.: 1751345

The figure shows a 10-position version of the product

<http://eshop.phoenixcontact.de/phoenix/treeViewClick.do?UID=1751345>

PC terminal block, Nominal current: 10 A, Nom. voltage: 160 V,
Pitch: 3.5 mm, Number of positions: 12, Type of connection: Screw
connection, Assembly: Soldering, Conductor/PCB connection
direction: 0 °, Color: green

Commercial data

EAN	4017918103903
Pack	50 pcs.
Customs tariff	85369010
Weight/Piece	0.0062 KG
Catalog page information	Page 49 (CC-2007)

Product notes

WEEE/RoHS-compliant since:
01/01/2003



<http://www.download.phoenixcontact.com>
Please note that the data given here has been taken from the online catalog. For comprehensive information and data, please refer to the user documentation. The General Terms and Conditions of Use apply to Internet downloads.

Technical data

Dimensions / positions

Pitch	3.5 mm
Dimension a	38.5 mm
Number of positions	12

Pin dimensions	0,5 x 0,9 mm
Hole diameter	1.1 mm
Screw thread	M2
Tightening torque, min	0.22 Nm
Tightening torque max	0.25 Nm

Technical data

Insulating material group	I
Rated surge voltage (III/3)	2.5 kV
Rated surge voltage (III/2)	2.5 kV
Rated surge voltage (II/2)	2.5 kV
Rated voltage (III/2)	200 V
Rated voltage (II/2)	400 V
Connection in acc. with standard	EN-VDE
Nominal current I_N	10 A
Nominal voltage U_N	160 V
Nominal cross section	1 mm ²
Maximum load current	12 A
Insulating material	PA
Inflammability class acc. to UL 94	V0
Stripping length	5 mm

Connection data

Conductor cross section solid min.	0.14 mm ²
Conductor cross section solid max.	1.5 mm ²
Conductor cross section stranded min.	0.14 mm ²
Conductor cross section stranded max.	1 mm ²
Conductor cross section stranded, with ferrule without plastic sleeve min.	0.25 mm ²
Conductor cross section stranded, with ferrule without plastic sleeve max.	0.5 mm ²
Conductor cross section stranded, with ferrule with plastic sleeve min.	0.25 mm ²
Conductor cross section stranded, with ferrule with plastic sleeve max.	0.5 mm ²
Conductor cross section AWG/kcmil min.	26
Conductor cross section AWG/kcmil max	16
2 conductors with same cross section, solid min.	0.14 mm ²

2 conductors with same cross section, solid max.	0.5 mm ²
2 conductors with same cross section, stranded min.	0.14 mm ²
2 conductors with same cross section, stranded max.	0.2 mm ²

Certificates / Approvals



Certification CB, CCA, CSA, CUL, GOST, SEV, UL

CSA

Nominal voltage U_N	300 V
Nominal current I_N	10 A
AWG/kcmil	28-16

CUL

Nominal voltage U_N	300 V
Nominal current I_N	10 A
AWG/kcmil	30-16

UL

Nominal voltage U_N	300 V
Nominal current I_N	10 A
AWG/kcmil	30-16

Drawings

Drilling diagram

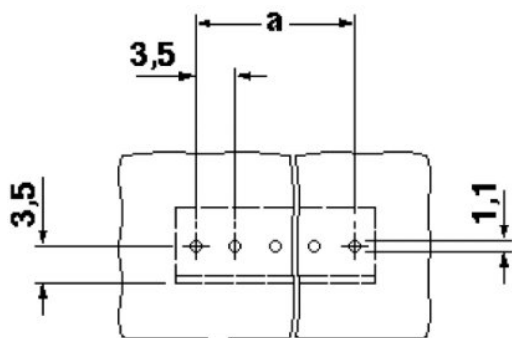

Dimensioned drawing

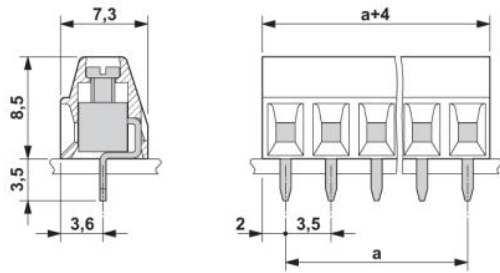

Address

PHOENIX CONTACT GmbH & Co. KG
Flachmarktstr. 8
32825 Blomberg, Germany
Phone +49 5235 3 00
Fax +49 5235 3 41200
<http://www.phoenixcontact.de>



© 2009 Phoenix Contact
Technical modifications reserved;