

## The Company

*Amphenol Canada Corp.* a subsidiary of Amphenol Corporation, is an international leader in the manufacture of *Filtered Connectors* and *Specialty Interconnect Devices*, and has been pioneering EMI and EMP technologies for more than 40 years.

Located in Toronto, Canada, our ISO 9001 certified facility employs approximately 400 people. Our activities are dedicated to the design, development and manufacture of EMI/EMP filter

connector products which are used in Commercial, Industrial, Communications, Military and Aerospace applications worldwide. Our expertise in understanding and supporting our customers' filter interconnect needs has earned Amphenol Canada a reputation of quality and excellence among the world's leading users of electronic components.

## What is a Filtered Connector?

A **filtered connector** is the combination of filter elements in a connector, forming one neat, compact interconnect device that can filter unwanted EMI. The most popular configuration is when

capacitors are mounted inside the connector between each of the contacts and the connector ground shell.

## Benefits

**Better EMI Control** – With minimized lead inductances and short, direct paths to ground of the filter, performance will typically out perform the same filter components on a P.C.B. by a factor of three to one.

**PCB Space Savings** – Incorporating filter elements into the connector, enables simplification of the required filter schematic for the necessary performance plus a savings of 2-4 square inches.

**Cost Savings** – Filter elements, such as inductors and capacitors, must no longer be purchased, stocked, assembled or tested. Fewer components means greater reliability at lower cost.

**Easy EMI/RFI Upgrade** – These compact filtered connectors fit standard non-filtered connector footprints. For improved EMC performance, simply replace the existing connector with a filtered connector.

**EMC Compliance & Immunity** – EMI that is generated from the electronic device, radiated or conducted, will be re-directed to chassis ground through the connector shell. This same device will also protect the system from external EMI/RFI noise (such as radio transmitters, ESD, or natural phenomena such as lightning) in the same way.

## Choosing the Right Capacitance for Your Filter Connector

- (1) Determine the highest frequency that the filter connector needs to pass unaffected.
- (2) Which frequencies are causing trouble, either with emissions or with immunity to interference?

- (3) Scan the Insertion Loss charts on page 2 to select a filter which provides little or no insertion loss (filtering) at the frequency determined from step 1, yet gives the greatest possible insertion loss at the frequencies determined in step 2.

Nominal Insertion Loss values described in this catalog are based on the Mil-STD-220 test method - a 50 ohm balanced load and source impedance. Different systems will differ from this and

hence, the filter connector may perform differently. The final decision will be determined from actual EMI/RFI testing of the equipment in question.

# FCC17 & FCC57 Series

## ELECTRICAL DATA

**Contact Resistance:** 15 milliohms maximum per MIL-STD-1344 Method 3002  
**Insulation Resistance:** 3000 megohms minimum per MIL-STD-1344 Method 3003.1  
**Current Rating:** 5 Amps DC maximum  
 2 Amps RF filtering maximum  
**FCC17 Combo:** 20-40 Amps

### Filter Performance:

Filter Capacitance (pF) @25°C, 1 kHz, 1.0 VRMS	50	180	330	470	820	1000	1200	2200	5600	47000	
	± 15%	± 15%	± 15%	± 15%	± 15%	± 15%	± 15%	± 15%	± 20%	± 20%	
Dielectric Material: NPO or X7R											
Insertion Loss (dB) (per MIL-STD-220 @ 25°C)	.5 MHz								3	15	
	1 MHz								5	20	
	5 MHz			1	1	1	1	5	11	27	
	10 MHz			1	2	3	3	4	8	16	32
	50 MHz		4	7	11	16	16	17	23	32	32
	100 MHz	2	12	15	22	30	30	30	32	32	32
	200 MHz	12	27	28	30	32	32	32	32	32	32
	1000 MHz	32	32	32	32	32	32	32	32	32	32
Working Voltage (VDC)	300	300	300	300	200	200	200	200	200	50	
DWV (VDC) *	600	600	600	600	600	600	600	600	600	150	

NOTE: A larger range of capacitors available - consult factory.

\* FCC57 connectors can be specified to meet the requirements of FCC Docket 20780, Part 68, Subpart F (1000 VAC for one minute. Consult factory for details).

FCC17 and FCC57 connectors can withstand a transient voltage spike of 700 V with a rise time of 1 µsec (500 V for 47000 pF).

FCC17 and FCC57 connectors can be specified to meet higher DWV and transient voltage requirement (consult factory).

## Typical Insertion Loss Performance (dB) (Per MIL-STD-220, no load)

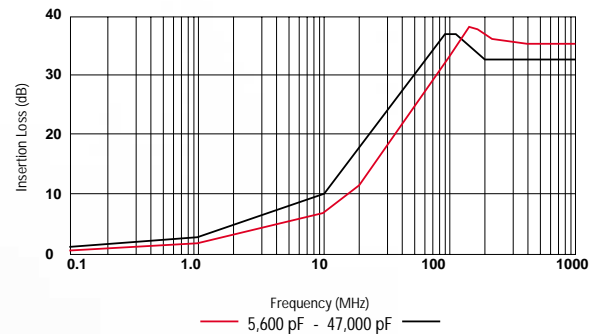
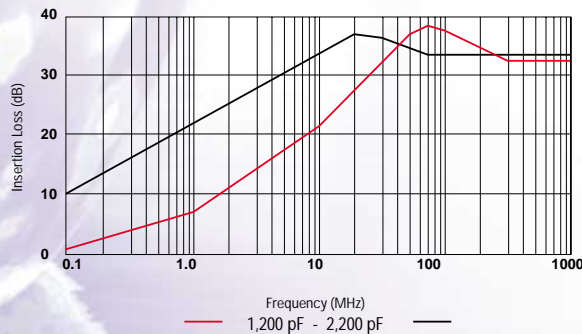
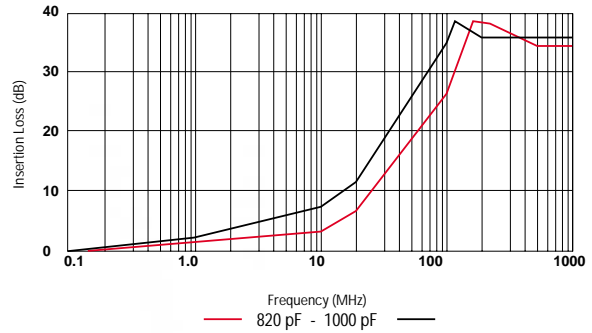
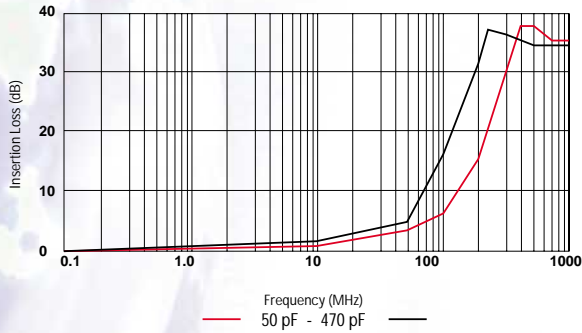

# FCC17 & FCC57 Series

## MECHANICAL DATA

### FCC17 Series Construction

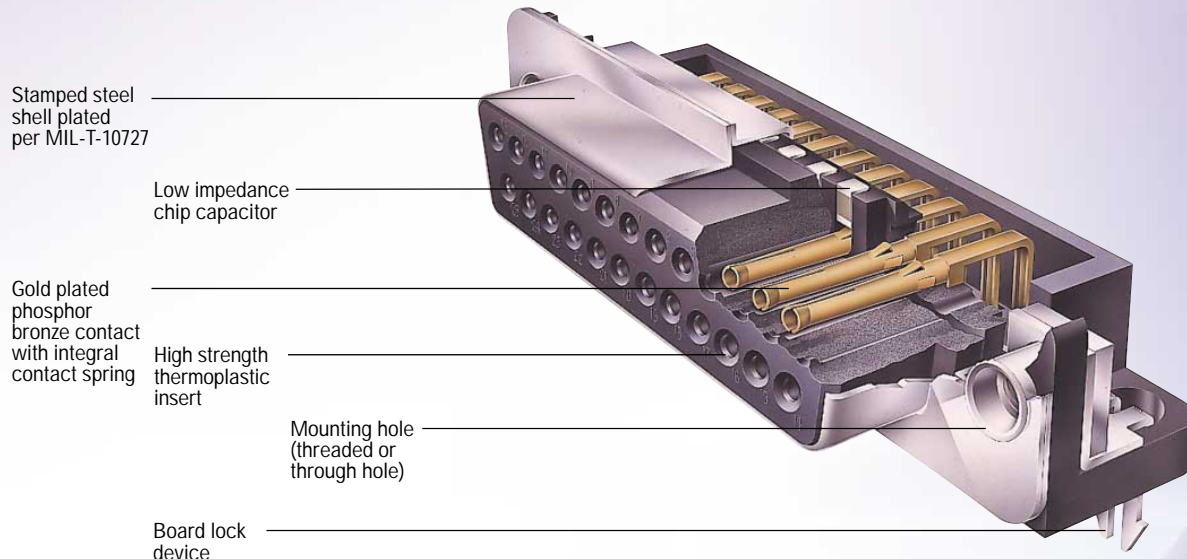

### FCC17 & FCC57 Mechanical & Environmental Data

#### MATERIALS

##### FCC17

**Shell** Stamped Steel;  
Tin Plated

**Contacts** Phosphor Bronze;  
15 $\mu$  inches  
[0.38 microns]  
Au over Ni  
Optional 50 $\mu$  inches  
[1.27 microns]  
Au available

##### FCC17 Combo

Copper Alloy  
30 $\mu$  inches  
[0.76 microns]  
Au over Ni

**Inserts** High Strength  
Thermoplastic.  
Complies with UL  
flammability  
requirements of  
94V-0 per UL-STD-94.

##### FCC57

**Shell** Stamped Steel,  
Zinc or Aluminum  
Diecast; Tin Plated

**Contacts** Phosphor Bronze;  
30 $\mu$  inches  
[0.76 microns]  
Au over Ni  
Optional 50 $\mu$  inches  
[1.27 microns]  
Au available

**Inserts** High Strength  
Thermoplastic.  
Complies with UL  
flammability  
requirements of  
94V-0 per UL-STD-94.

#### ENVIRONMENTAL

##### FCC17 & FCC57

**OPERATING TEMPERATURE** • -40°C to +85°C

**TEMPERATURE CYCLING** • To MIL-STD-1344,  
Method 1003, Test Cond. A

**HUMIDITY** • To MIL-STD-1344,  
Method 1002, Type I,  
Test Condition C

**VIBRATION** • To MIL-STD-1344,  
Method 2005, Test Cond. III

**DURABILITY** • 200 Cycles Minimum,  
to MIL-STD-1344,  
Method 2016

**UL File #** E135615  
**CSA File #** LR68598

# FCC17 Series

## FILTERED D-SUB CONNECTORS

### Specifications

Filter Characteristics: See Page 2  
 Electrical Data: See Page 2  
 Material and Finishes: See Page 3  
 Environmental Data: See Page 3  
 UL File # : E135615  
 CSA File # : LR68598



These products are protected by U.S. Patent # 4500159

### Ordering Information – D-Sub

**FCC17 - B25 S C - 4 4 0 G**

<p><b>FCC17</b> SERIES DESIGNATION</p> <p><b>B25</b> SIZE E09 A15 B25 C37</p> <p><b>S</b> CONNECTOR TYPE A - Adapter P - Pin S - Socket</p> <p><b>C</b> TERMINATION TYPE A - Right Angle PC Tail, .318" [8.08 mm] Footprint B - Right Angle PC Tail, .405" [10.29 mm] Footprint C - Right Angle PC Tail, .590" [14.99 mm] Footprint D - Pin/Socket Adapter E - Vertical Mount PC Tail M - Solder Cup N - Vertical Mount PC Tail - Long Body</p> <p><b>4</b> MOUNTING OPTIONS* A: 4-40 Threaded PC Tail Standoffs with Boardlock, Vertical Mount Only E: 4-40 Hex Jack Sockets (supplied loose) F: 4-40 Round Fixed Jack Sockets 2: .120 [3.05 mm] diameter Through hole 3: Self-Locking 4-40 Threaded Inserts 4: 4-40 Threaded Inserts (Standard) 5: 4-40 Threaded Stand-Offs, Vertical Mount 6: M3 Threaded inserts</p>	<p><b>SPECIALS</b> No Digit: Standard 15µ inches gold G: 50 micro inches gold K: 30 micro inches gold L: Standard Connector with added ferrite block</p> <p><b>MODIFIER</b> 0 = Standard Product (Boardlocks on Right Angle D-Subs) B = Metal Mounting Brackets, for Right Angle D-Subs D = .315" to Boardlock for .590" footprint E = Plastic Bracket - No Boardlock F = No Boardlock, No plastic or metal Bracket - Alignment Strip Only X = Specials or Custom Versions</p> <p><b>FILTER CAPACITANCE [pF]*</b> D: 50 pF B: 100 pF 0: 180 pF F: 330 pF 1: 470 pF 4: 820 pF 5: 1,000 pF 7: 1,200 pF E: 2,200 pF 9: 5,600 pF 8: 47,000 pF</p>	<p><b>G</b></p> <p><b>0</b></p> <p><b>4</b></p>
--	---	---

\* For Additional Mounting Options and Filter Capacitance - Consult Factory

# FCC17 Series

## FILTERED D-SUB CONNECTORS

### Pin

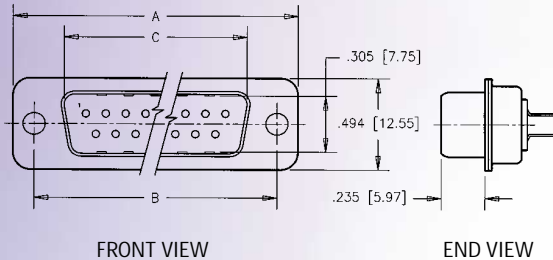

### Socket

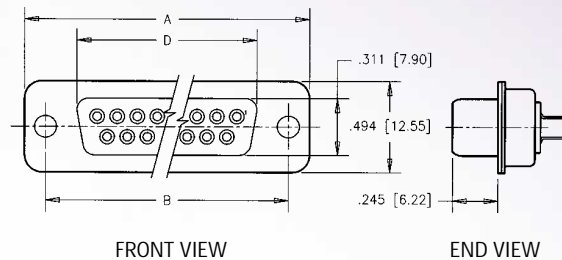

All Dimensions in Inches (mm)

Shell Size	Standard Number of Contacts	A	B	C (for pin connector)	D (for socket connector)
E	9	1.213 [30.81]	.984 [24.99]	.666 [16.92]	.643 [16.33]
A	15	1.541 [39.14]	1.312 [33.32]	.994 [25.25]	.971 [24.66]
B	25	2.088 [53.04]	1.852 [47.04]	1.534 [38.96]	1.511 [38.38]
C	37	2.729 [69.32]	2.500 [63.50]	2.182 [55.42]	2.159 [54.84]

## Mounting Dimensions

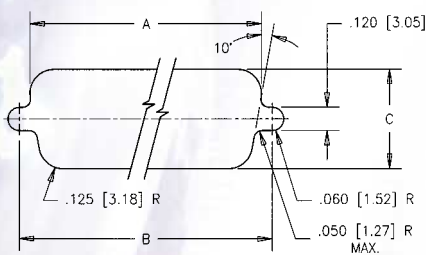

FRONT MOUNTING CUT-OUT

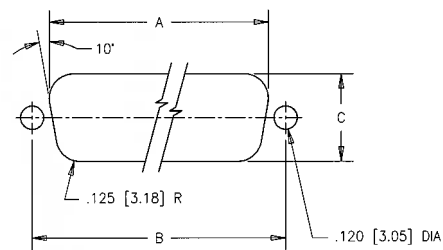

REAR MOUNTING CUT-OUT

Size	Mounting	A	B	C
9	Front	.875 [22.23]	.984 [24.99]	.512 [13.00]
	Rear	.807 [20.50]	.984 [24.99]	.449 [11.40]
15	Front	1.200 [30.48]	1.312 [33.32]	.512 [13.00]
	Rear	1.134 [28.80]	1.312 [33.32]	.449 [11.40]
25	Front	1.744 [44.30]	1.852 [47.04]	.512 [13.00]
	Rear	1.673 [42.49]	1.852 [47.04]	.449 [11.40]
37	Front	2.389 [60.68]	2.500 [63.50]	.512 [13.00]
	Rear	2.326 [59.08]	2.500 [63.50]	.449 [11.40]

# FCC17 Series

## FILTERED D-SUB CONNECTORS

### Vertical Mount

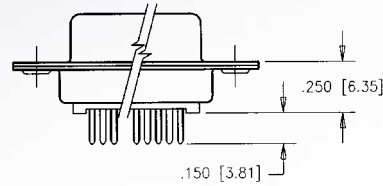

Termination Type E

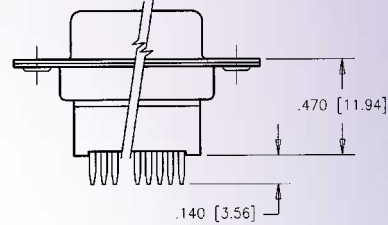

Termination Type N

### Right Angle, with Boardlocks & Plastic Mounting Brackets

.318" FOOTPRINT

.405" FOOTPRINT

.590" FOOTPRINT

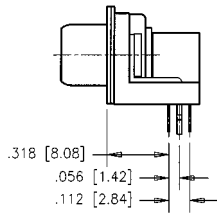

Termination Type A  
with Modifier option O

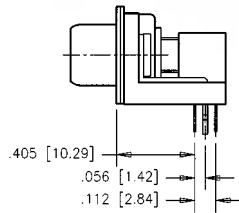

Termination Type B  
with Modifier option O

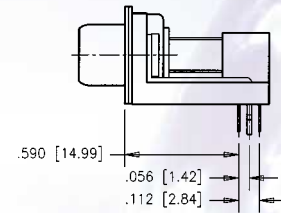

Termination Type C  
with Modifier option O

### Right Angle, with Metal Mounting Brackets

.318" FOOTPRINT

.405" FOOTPRINT

.590" FOOTPRINT

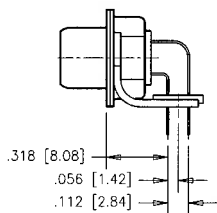

Termination Type A  
with Modifier option B

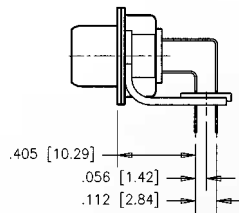

Termination Type B  
with Modifier option B

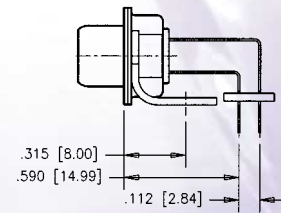

Termination Type C  
with Modifier option B

# FCC17 Series

## FILTERED D-SUB CONNECTORS

### Solder Cup Termination

Termination type M

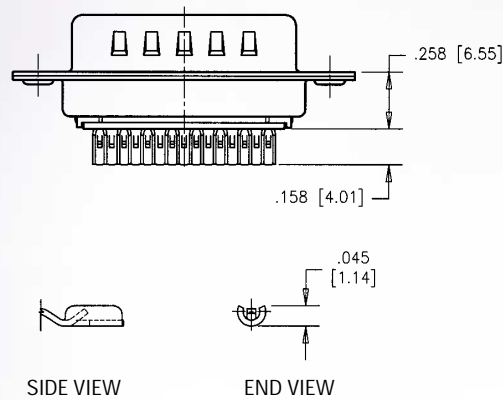

SOLDER CUP DETAIL  
(ACCEPTS UP TO 20 AWG WIRE)

### Pin-to-Socket Adapter

Termination type D

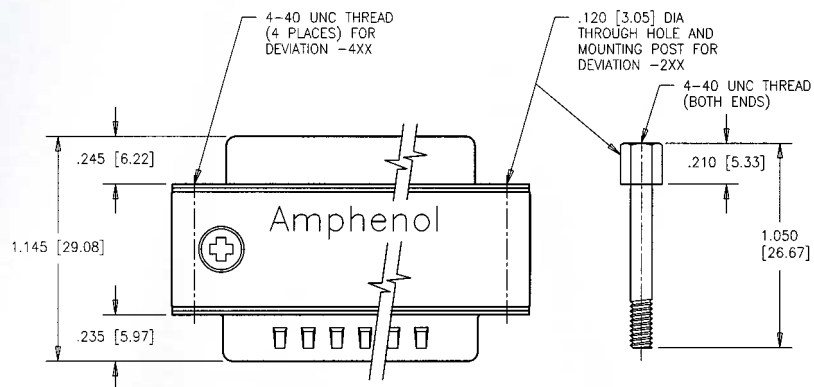

**Mounting Options**  
Through Hole with Mounting Post  
4-40 Threaded Inserts

**Part No. Example**  
FCC17-B25AD-2x0  
FCC17-B25AD-4x0

x = To complete the P/N, see page 5 to assign Filter Capacitance Code.  
For electrical and mechanical specifications, see pages 2 and 3.

### Mounting Options (on Flange)

Shown for Vertical Mount Connectors. Codes 2, 3, 4, 6, E and F also available on right angle connectors.

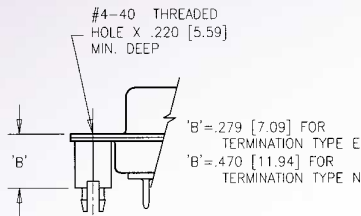

**-Axx**  
4-40 Threaded Standoffs with Boardlocks (Vertical Mount only)  
Mounting code A

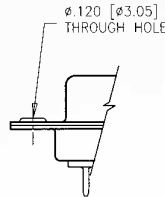

**-2xx**  
.120" (3.05 mm) diameter thru hole  
Mounting code 2

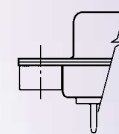

**-3xx, 4xx and 6xx**  
4-40 Threaded Inserts - Self locking  
4-40 Threaded inserts (standard)  
M3 threaded inserts  
Mounting codes 3, 4 and 6

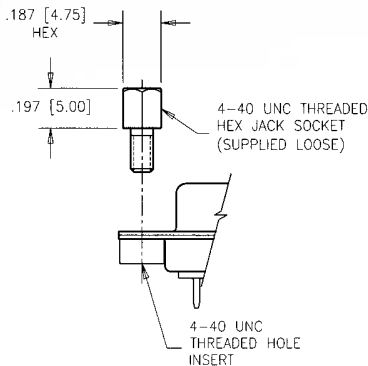

**-Exx**  
4-40 Hex Jack Sockets (supplied loose)  
Mounting code E

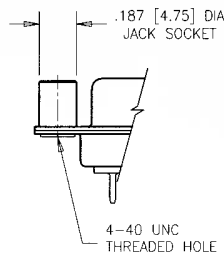

**-Fxx**  
4-40 Round fixed Jack Sockets  
Mounting code F

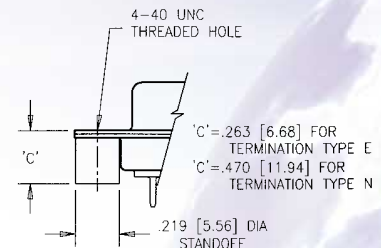

**-5xx**  
4-40 Threaded Standoff (vertical mount only)  
Mounting code 5

### Bracket Options & Specials

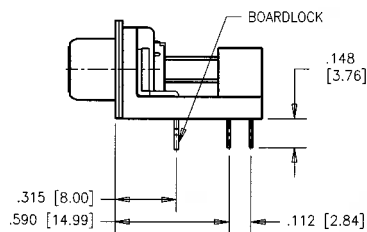

**-xxD**  
.315" to Boardlock for .590" Footprint only  
Modifier option D

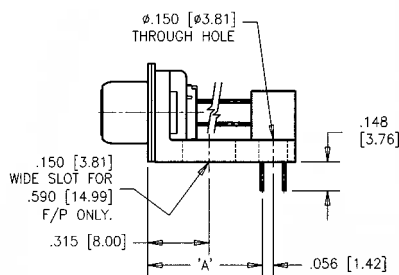

**-xxE**  
Plastic bracket only  
Modifier option E

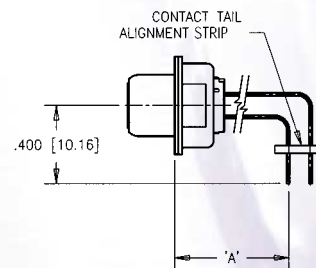

**-xxF**  
Alignment Strip Only  
No bracket or boardlocks  
Modifier option F

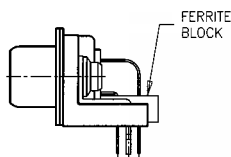

**FERRITE**  
Consult Factory for details

Termination Type	"A" Dimension
A	.318 (8.08)
B	.405 (10.29)
C	.590 (14.99)



# FCC17 Series

## FILTERED D-SUB CONNECTORS

### PCB Layout

#### 9 SIZE

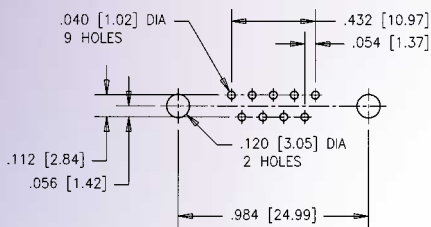

Standard PCB layout

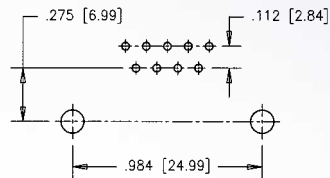

PCB layout for .590° footprint with Modifier Options B or D only

#### 15 SIZE

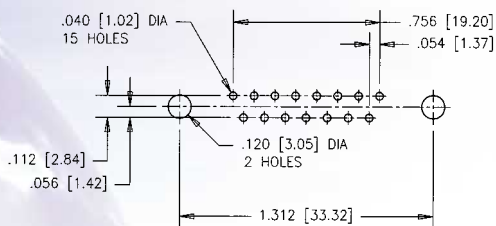

Standard PCB layout

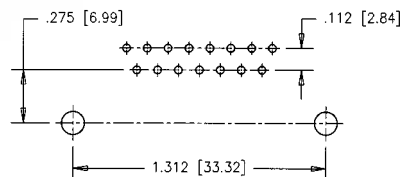

PCB layout for .590° footprint with Modifier Options B or D only

#### 25 SIZE

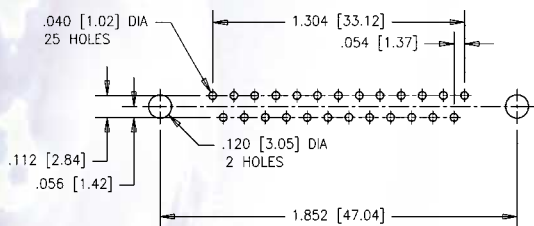

Standard PCB layout

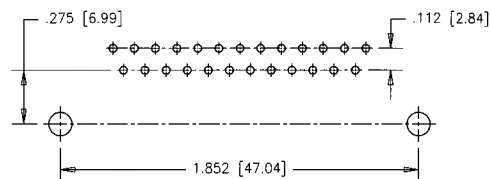

PCB layout for .590° footprint with Modifier Options B or D only

#### 37 SIZE

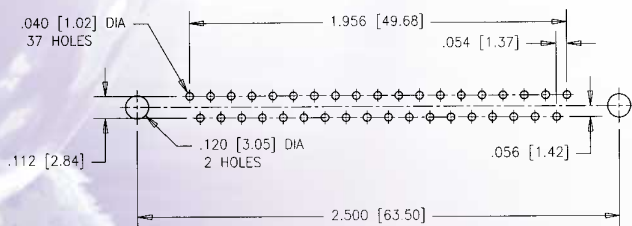

Standard PCB layout

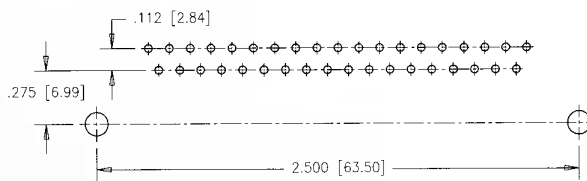

PCB layout for .590° footprint with Modifier Options B or D only