

Photoelectric sensor in compact stainless steel housing

E3ZM

- Compact size SUS 316L housing for highest mechanical protection
- Tested detergent and chemical resistance (certified by Henkel-Ecolab)
- Watertight construction for highest protection when cleaned with high pressure



Application

Detergent resistance

proven in intensive testing



Product name	Concentration	Temperature	Time
Sodium hydroxide (NaOH)	1.5 %	70 °C	240 h
Potassium hydroxide (KOH)	1.5 %	70 °C	240 h
Phosphoric acid (H ₃ PO ₄)	2.5 %	70 °C	240 h
Sodium hypochlorite (NaClO)	0.3 %	25 °C	240 h
Hydrogen peroxide (H ₂ O ₂)	6.5 %	25 °C	240 h
P3-topax-66s (Manufactured by Ecolab)	3.0 %	70 °C	240 h
P3-topax-56 (Manufactured by Ecolab)	5.0 %	70 °C	240 h
P3-oxonia active 90 (Manufactured by Ecolab)	1.0 %	25 °C	240 h
TEK121 (Manufactured by ABC Compounding)	1.1 %	25 °C	240 h

Product concept for highest machine hygiene



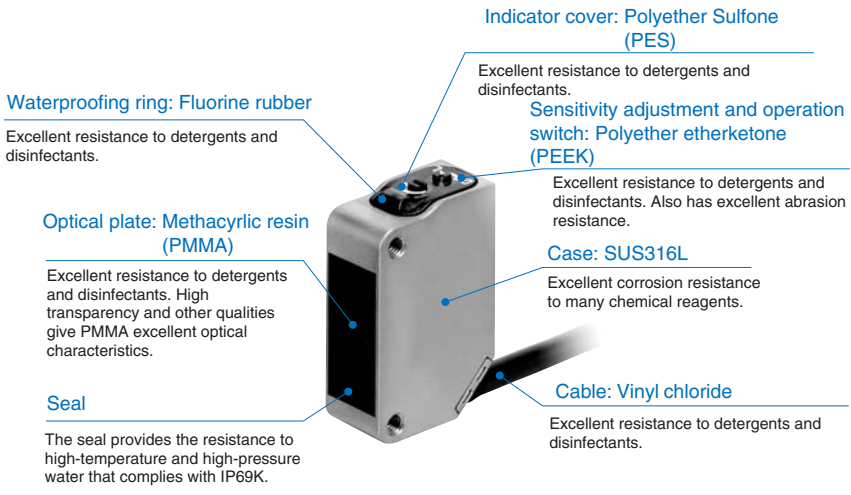
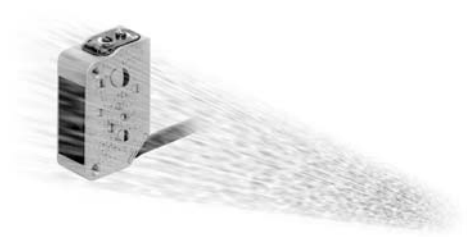



and often cleaned environments.

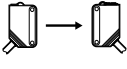

Ordering Information

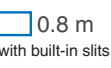
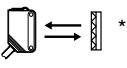
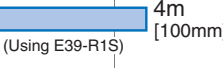
Sensors

 Red light  Infrared light

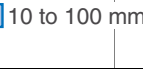
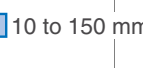
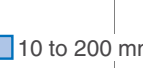
Sensor type	Appearance	Connection method	Sensing distance	Model	
				NPN output	PNP output
Through-beam *1		Pre-wired (2 m) *2	 15m	E3ZM-T61	E3ZM-T81
		Connector type (M8, 4 pins) *3		E3ZM-T66	E3ZM-T86
		Pre-wired (2 m) *2	 0.8 m with built-in slits	E3ZM-T63	E3ZM-T83
		Connector type (M8, 4 pins) *3		E3ZM-T68	E3ZM-T88
Retroreflective (with M.S.R. function)	 *4	Pre-wired (2 m) *2	 4m [100mm] *5 (Using E39-R1S)	E3ZM-R61	E3ZM-R81
		Connector type (M8, 4 pins) *3		E3ZM-R66	E3ZM-R86
Diffuse-reflective		Pre-wired (2 m) *2	 1m	E3ZM-D62	E3ZM-D82
		Connector type (M8, 4 pins) *3		E3ZM-D67	E3ZM-D87
BGS reflective (fixed distance)		Pre-wired (2 m) *2	 10 to 100 mm	E3ZM-LS61H	E3ZM-LS81H
		Connector type (M8, 4 pins) *3		E3ZM-LS66H	E3ZM-LS86H
		Pre-wired (2 m) *2	 10 to 150 mm	E3ZM-LS62H	E3ZM-LS82H
		Connector type (M8, 4 pins) *3		E3ZM-LS67H	E3ZM-LS87H
		Pre-wired (2 m) *2	 10 to 200 mm	E3ZM-LS64H	E3ZM-LS84H
		Connector type (M8, 4 pins) *3		E3ZM-LS69H	E3ZM-LS89H

- *1. Through-beam Models are also available with a light emission stop function. When ordering, add "-G0" to the end of the model number (e.g., E3ZM-T61-G0).
- *2. Pre-wired Models with a 5 m cable are also available for these products. When ordering, specify the cable length by adding "5M" to the end of the model number (e.g., E3ZM-LT61 5M).
M12 Pre-wired Connector Models are also available. When ordering, add "-M1J" to the end of the model number (e.g., E3ZM-R61-M1J 0.3m).
- *3. M8 Connector Models are also available with three-pin connectors. When ordering, add "-M5" to the end of the model number (e.g., E3ZM-T66-M5).
This does not apply to BGS Reflective Models, however, because they require 4 pins.
- *4. The Reflector is sold separately. Select the Reflector model most suited to the application.
- *5. Values in parentheses indicate the minimum required distance between the Sensor and Reflector..









Accessories

Reflectors

Name	E3ZM-R Sensing distance (typical) *1	Model	Quantity	Remarks
Reflector	3 m [100 mm] (rated value)	E39-R1	1	<ul style="list-style-type: none"> • Reflectors are not provided with Retro-reflective models. • The MSR function is enabled.
	4 m [100 mm] (rated value)	E39-R1S	1	
	5 m [100 mm]	E39-R2	1	
	2.5 m [100 mm]	E39-R9	1	
	3.5 m [100 mm]	E39-R10	1	
Fog preventing	3 m [100 mm]	E39-R1K	1	
Small reflector	1.5 m [50 mm]	E39-R3	1	
Tape Reflector	700 mm [150 mm]	E39-RS1	1	
	1.1 m [150 mm]	E39-RS2	1	
	1.4 m [150 mm]	E39-RS3	1	

- *1. Values in parentheses indicate the minimum required distance between the Sensor and Reflector.
- Note: 1. When using a Reflector without a rated value, use 0.7 times typical value as a guideline for the sensing distance.
2. For stainless steel and glass covered reflectors please contact your OMRON representative.

Mounting Brackets







Shape	Model	Quantity	Remarks	Appearance	Model	Quantity	Remarks
	E39-L153	1	Mounting Brackets		E39-L98	1	Metal Protective Cover Bracket *1
	E39-L104	1			E39-L150	One set	(Sensor adjuster)
	E39-L43	1	Horizontal Mounting Bracket *1		E39-L151	One set	Easily mounted to the aluminum frame rails of conveyors and easily adjusted. For left to right adjustment
	E39-L142	1	Horizontal Protective Cover Bracket *1				
	E39-L44	1	Rear Mounting Bracket		E39-L144	1	Compact Protective Cover Bracket *1

*1. Cannot be used for Standard Connector models.

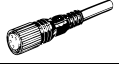
Note: 1. When using Through-beam Models, order one bracket for the Receiver and one for the Emitter.

Sensor I/O Connectors

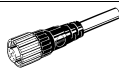
General Purpose

Size	Cable	Appearance	Cable type		Model
M8 (4 pins)	Standard	Straight 	2 m	4-wire type	XS3F-M421-402-A
			5 m		XS3F-M421-405-A
		L-shaped 	2 m		XS3F-M422-402-A
			5 m		XS3F-M422-405-A
M12 (For -M1J models)		Straight 	2 m	3-wire type	XS2F-D421-DC0-A
			5 m		XS2F-D421-GC0-A
			2 m		XS2F-D422-DC0-A
			L-shaped 	5 m	XS2F-D422-GC0-A
	Straight 			2 m	4-wire type
			5 m	XS2F-D421-G80-A	
		2 m	XS2F-D422-D80-A		
	L-shaped 	5 m	XS2F-D422-G80-A		

Note: Depending on the connector specification, the IP67 performance applies. When using high-pressure washing, use a suitable connector.

Detergent resistant sensor I/O connectors

Please contact your OMRON representative for sensor connectors with stainless steel nuts.

Rating and Specifications

		Through-beam		Retroreflective model (with M.S.R. function)	Diffuse-reflective Models	
Item	Sensor method					
	Model	NPN output	E3ZM-T61 E3ZM-T66	E3ZM-T63 E3ZM-T68	E3ZM-R61 E3ZM-R66	E3ZM-D62 E3ZM-D67
		PNP output	E3ZM-T81 E3ZM-T86	E3ZM-T83 E3ZM-T88	E3ZM-R81 E3ZM-R86	E3ZM-D82 E3ZM-D87
Sensing distance		15 m	0.8 m	4 m [100 mm] (Using E39-R1S) 3 m [100 mm] (Using E39-R1)	1 m (White paper 300 x 300 mm)	
Spot Diameter (typical)		---				
Standard sensing object		Opaque: 12 mm dia. min.	Opaque: 2 mm dia. min.	Opaque: 75 mm dia. min.	---	
Differential travel		---			20% max. of sensing distance max.	
Black/white error		---				
Directional angle		Emitter and Receiver: 3° to 15°		Sensor: 3° to 10° Reflector: 30°	---	
Light source (wave length)		Infrared LED (870 nm)		Red LED (660 nm)	Infrared LED (860 nm)	
Power supply voltage		10 to 30 VDC, including 10% ripple (p-p)				
Current consumption		Emitter, Receiver: 20 mA max. each		25 mA max.		
Control output		Load power supply voltage: 30 VDC max., Load current: 100 mA max. (Residual voltage: 2 V max.) Open-collector output (NPN/PNP output depending on model) Light-ON/Dark-ON switch selectable				
Protection circuits		Reversed power supply polarity protection, Output short-circuit protection, and Reversed output polarity protection		Reversed power supply polarity protection, Output short-circuit protection, Mutual interference prevention, and Reversed output polarity protection		
Response time		Operate or reset: 1 ms max.				
Sensitivity adjustment		One-turn adjuster				
Ambient illumination (Receiver side)		Incandescent lamp: 3,000 lx max. Sunlight 10,000 lx max.				
Ambient temperature range		Operating: -25°C to 55°C, Storage: -40°C to 70°C (with no icing or condensation)				
Ambient humidity range		Operating: 35% to 85%, Storage: 35% to 95% (with no condensation)				
Insulation resistance		20 MΩ min. at 500 VDC				
Dielectric strength		1,000 VAC at 50/60 Hz for 1 min				
Vibration resistance		Destruction: 10 to 55 Hz, 1.5 mm double amplitude for 2 hours each in X, Y, and Z directions				
Shock resistance		Destruction: 500 m/s ² 3 times each in X, Y, and Z directions				
Degree of protection *1		IEC: IP67, DIN 40050-9: IP69K				
Connection method		Pre-wired cable (standard length: 2 m) Standard M8 4-pin Connector				
Indicator		Operation indicator (yellow), Stability indicator (green) (Emitter has only power supply indicator (green).)				
Weight (packed state)	Pre-wired cable	Approx. 150 g		Approx. 90 g		
	Standard Connector	Approx. 60 g		Approx. 40 g		
Materials	Case	SUS316L				
	Lens	Methacrylic resin				
	Display	PES (polyether sulfone)				
	Sensitivity adjustment and operation switch	PEEK (polyether ether ketone)				
	Seals	Fluoro rubber				
Accessories		Instruction sheet (Note: Reflectors and Mounting Brackets are sold separately.)				

*1. IP69K Degree of Protection Specification IP69K is a protection standard against high temperature and high-pressure water defined in the German standard DIN 40050, Part 9. The test piece is sprayed with water at 80°C at a water pressure of 80 to 100 BAR using a specified nozzle shape. The distance between the test piece and nozzle is 10 to 15 cm, and water is sprayed horizontally for 30 seconds each at 0°, 30°, 60°, and 90° while rotating the test object on a horizontal plane.

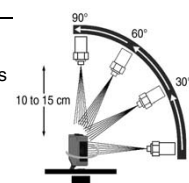

Rating and Specifications

Sensor method		BGS Reflective Models		
Item	Model			
	NPN output	E3ZM-LS61H E3ZM-LS66H	E3ZM-LS62H E3ZM-LS67H	E3ZM-LS64H E3ZM-LS69H
	PNP output	E3ZM-LS81H E3ZM-LS86H	E3ZM-LS82H E3ZM-LS87H	E3ZM-LS84H E3ZM-LS89H
Sensing distance		10 to 100 mm (White paper 100 × 100 mm)	10 to 150 mm (White paper 100 × 100 mm)	10 to 200 mm (White paper 100 × 100 mm)
Spot Diameter (typical)		4 mm dia. at sensing distance of 100 mm	12 mm dia. at sensing distance of 150 mm	18 mm dia. at sensing distance of 200 mm
Standard sensing object		---		
Differential travel		3% of sensing distance max.	15% of sensing distance max.	20% of sensing distance max.
Black/white error		5% of sensing distance max.	10% of sensing distance max.	20% of sensing distance max.
Directional angle		---		
Light source (wave length)		Red LED (650 nm)	Red LED (660 nm)	
Power supply voltage		10 to 30 VDC, including 10% ripple (p-p)		
Current consumption		25 mA max.		
Control output		Load power supply voltage: 30 VDC max., Load current: 100 mA max. (Residual voltage: 2 V max.) Open-collector output (NPN/PNP output depending on model) Light-ON/Dark-ON cable connection selectable		
Protection circuits		Reversed power supply polarity protection, Output short-circuit protection, Reversed output polarity protection, Mutual interference protection		
Response time		Operate or reset: 1 ms max.		
Sensitivity adjustment		---		
Ambient illumination (Receiver side)		Incandescent lamp: 3,000 lx max. Sunlight 10,000 lx max.		
Ambient temperature range		Operating: -25°C to 55°C, Storage: -40°C to 70°C (with no icing or condensation)		
Ambient humidity range		Operating: 35% to 85%, Storage: 35% to 95% (with no condensation)		
Insulation resistance		20 MΩ min. at 500 VDC		
Dielectric strength		1,000 VAC at 50/60 Hz for 1 minute		
Vibration resistance		Destruction: 10 to 55 Hz, 1.5 mm double amplitude for 2 hours each in X, Y, and Z directions		
Shock resistance		Destruction: 500 m/s ² 3 times each in X, Y, and Z directions		
Degree of protection *1		IEC: IP67, DIN 40050-9: IP69K		
Connection method		Pre-wired cable (standard length: 2 m) Standard M8 4-pin Connector		
Indicator		Operation indicator (yellow), Stability indicator (green)		
Weight (packed state)	Pre-wired cable	Approx. 90 g		
	Standard Connector	Approx. 40 g		
Materials	Case	SUS316L		
	Lens	Methacrylic resin		
	Display	PES (polyether sulfone)		
	Sensitivity adjustment and operation switch	PEEK (polyether ether ketone)		
	Seals	Fluoro rubber		
Accessories		Instruction sheet (Note: Mounting Brackets are sold separately.)		

*1. IP69K Degree of Protection Specification

*2. IP69K is a protection standard against high temperature and high-pressure water defined in the German standard DIN 40050,

*3. Part 9. The test piece is sprayed with water at 80°C at a water pressure of 80 to 100 BAR using a specified nozzle shape.

*4. The distance between the test piece and nozzle is 10 to 15 cm, and water is sprayed horizontally for 30 seconds

*5. each at 0°, 30°, 60°, and 90° while rotating the test object on a horizontal plane.

Engineering data (Typical)

Parallel Operating Range

Through-beam Models

E3ZM-T□1(T□6)

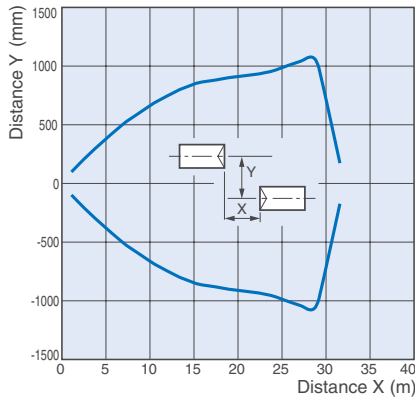

Retro-reflective Models

E3ZM-R□1(R□6)

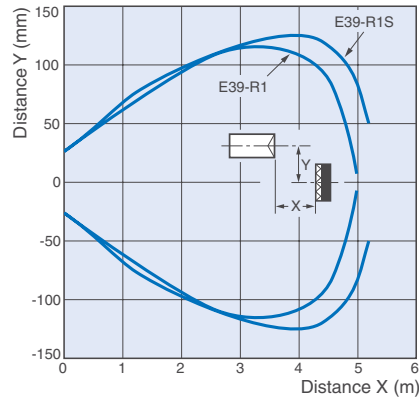

Operating Range

Diffuse-reflective Models

E3ZM-S□2(D□7)

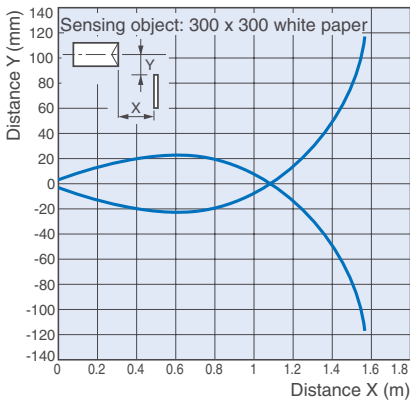

BGS Reflective Models

E3ZM-LS□1H(LS□6H), Top to Bottom

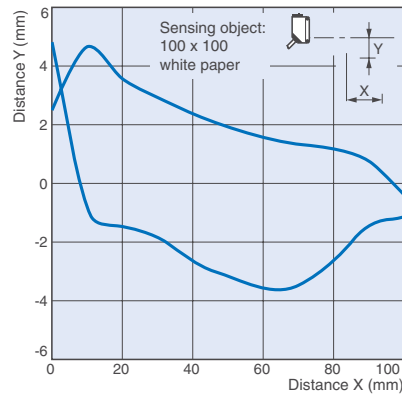

E3ZM-LS□1H(LS□6H), Left to Right

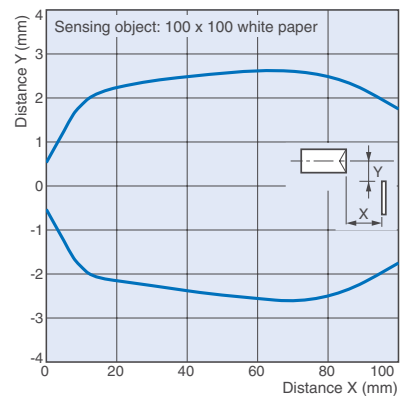

E3ZM-LS□2H(LS□7H), Top to Bottom

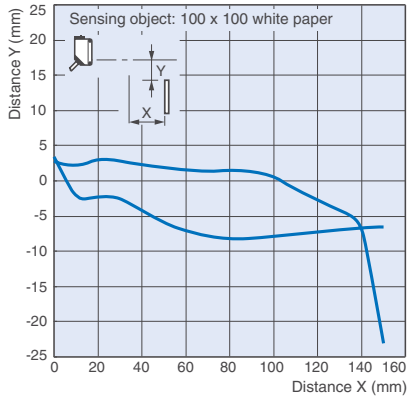

E3ZM-LS□2H(LS□7H), Left to Right

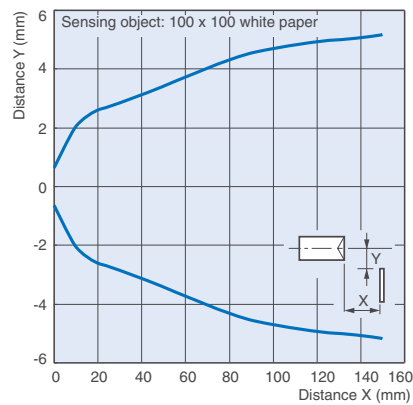

E3ZM-LS□4H(LS□9H), Top to Bottom

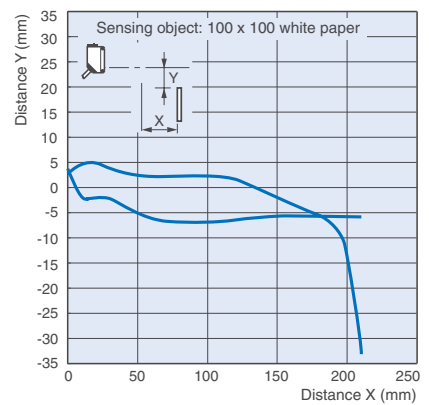

E3ZM-LS□4H(LS□9H), Left to Right

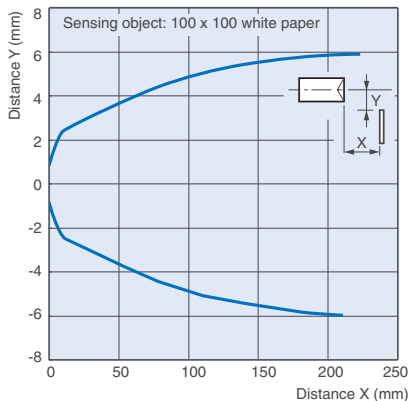

Excess Gain vs. Distance

Through-beam Models

E3ZM-T□1(T□6)

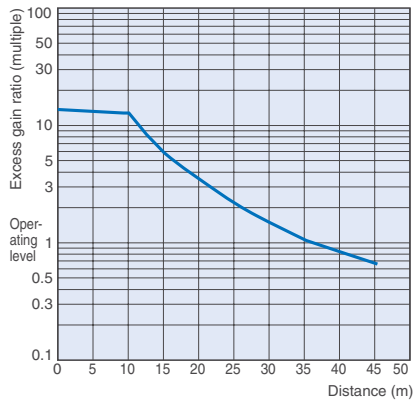

Retro-reflective Models

E3ZM-R□1(R□6)

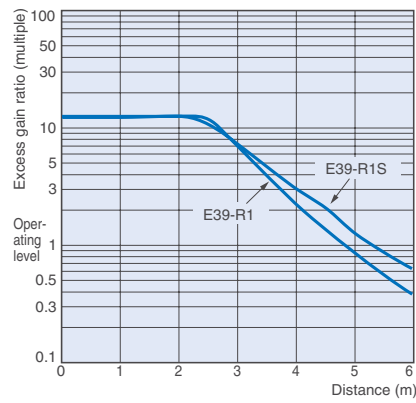

Diffuse-reflective Models

E3ZM-D□2(D□7)

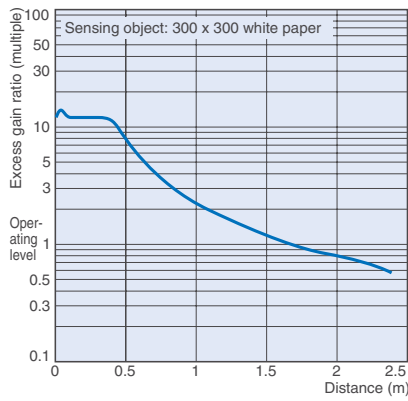

Sensing Object Size vs. Distance

Diffuse-reflective Models

E3ZM-D□2(D□7)

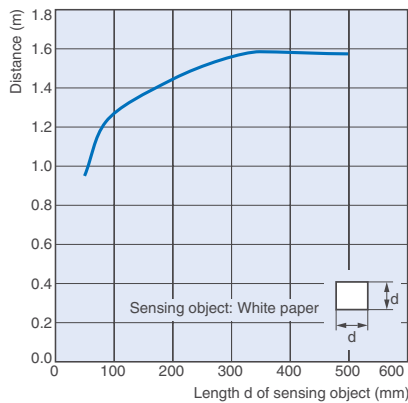

Spot Diameter vs. Distance

BGS Reflective Models

E3ZM-LS□1H(LS□6H)

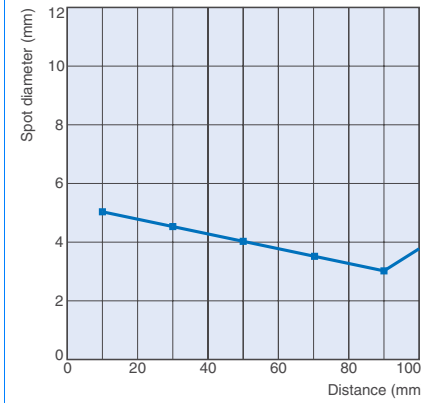

E3ZM-LS□2H/LS□4H(LS□7H/LS□9H)

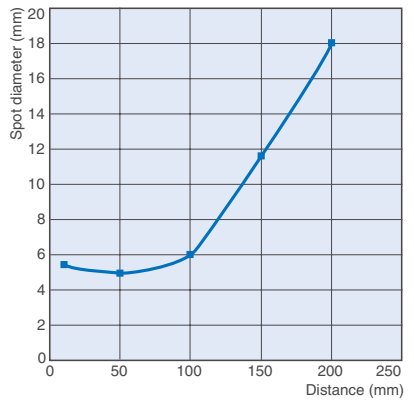

Sensing Distance vs. Sensing Object Material

BGS Reflective Models

E3ZM-LS□1H(LS□6H)

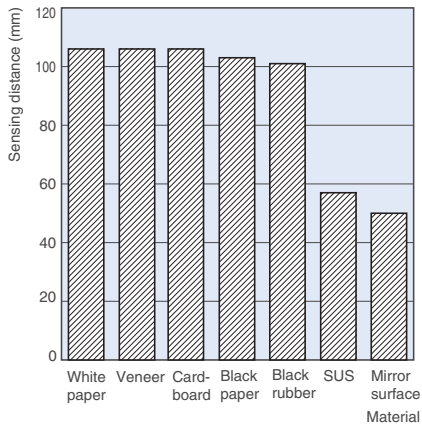

E3ZM-LS□2H(LS□7H)

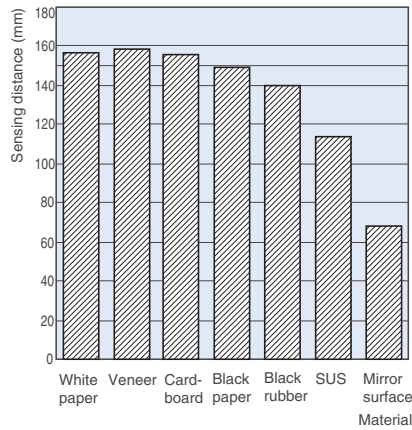

E3ZM-LS□4H(LS□9H)

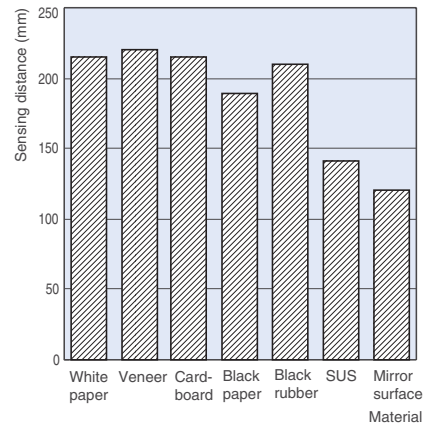

Inclination Characteristics (Vertical)

BGS Reflective Models

E3ZM-LS□1H(LS□6H)

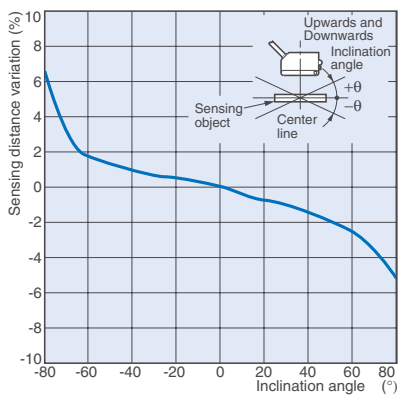

E3ZM-LS□2H(LS□7H)

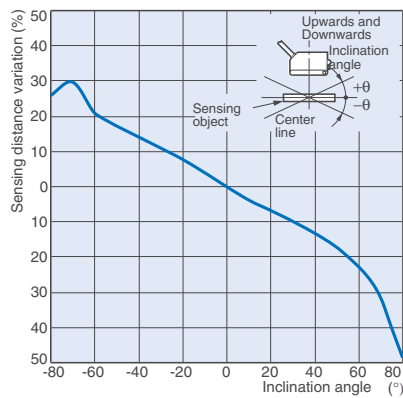

E3ZM-LS□4H(LS□9H)

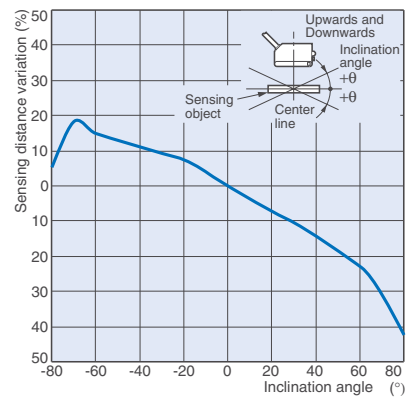

Inclination Characteristics (Horizontal)

BGS Reflective Models

E3ZM-LS□1H(LS□6H)

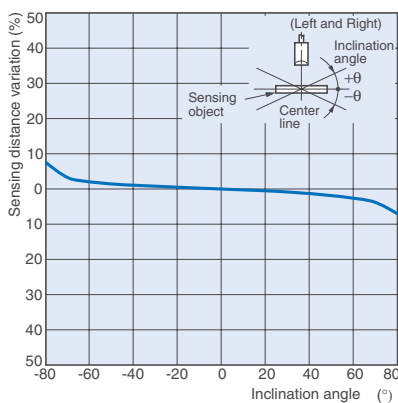

E3ZM-LS□2H(LS□7H)

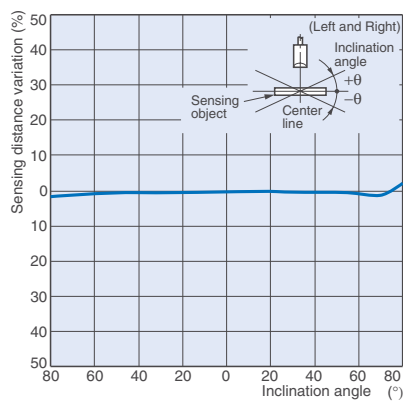

E3ZM-LS□4H(LS□9H)

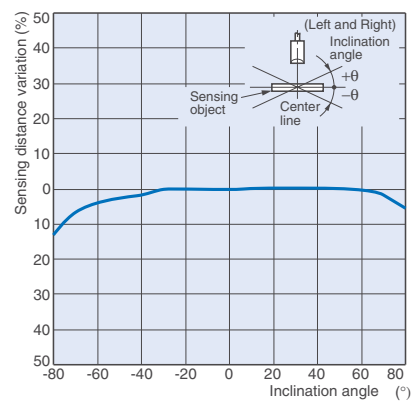

Output Circuit Diagram

NPN output

Model	Operation mode	Timing charts	Mode selector switch	Output circuit
E3ZM-T61 E3ZM-T63 E3ZM-T66 E3ZM-T68 E3ZM-R61 E3ZM-R66 E3ZM-D62 E3ZM-D67	Light ON		L side (LIGHT ON)	<p>Through-beam Receivers, Retro-reflective Models, Diffuse-reflective Models</p>
	Dark ON		D side (DARK ON)	
<p>Through-beam Emitter</p>				
E3ZM-T61-G0 E3ZM-T63-G0 E3ZM-T66-G0 E3ZM-T68-G0	---	<p>Light emission stop function</p> <p>Emitter LED</p> <p>Indicator (green)</p>	---	<p>Through-beam Emitter</p>
E3ZM-LS61H E3ZM-LS66H E3ZM-LS62H E3ZM-LS67H E3ZM-LS64H E3ZM-LS69H	Light ON		Connect pink lead (2) to brown lead (1).	
	Dark ON		Connect pink lead (2) to blue lead (3) or leave open.	

E3ZM

PNP output

Model	Operation mode	Timing charts	Mode selector switch	Output circuit
E3ZM-T81 E3ZM-T83 E3ZM-T86 E3ZM-T88 E3ZM-R81 E3ZM-R86 E3ZM-D81 E3ZM-D86 E3ZM-D82 E3ZM-D87	Light ON		L side (LIGHT ON)	
	Dark ON		D side (DARK ON)	
E3ZM-T81-G0 E3ZM-T83-G0 E3ZM-T86-G0 E3ZM-T88-G0	---		---	
E3ZM-LS81H E3ZM-LS86H E3ZM-LS82H E3ZM-LS87H E3ZM-LS84H E3ZM-LS89H	Light ON		Connect pink lead (2) to brown lead (1).	
	Dark ON		Connect pink lead (2) to blue lead (3) or leave open.	

Connector Pin Arrangement

M12 Pre-wired Connector (-M1J)
M12 Connector Pin Arrangement



M8 Connector/M8 Pre-wired Connector (-M3J)
M8 4-pin Connector Pin Arrangement



M8 Pre-wired 3-pin Connector (-M5J)
M8 3-pin Connector Pin Arrangement



Connectors (Sensor I/O connectors)

M8 4-pin Connectors

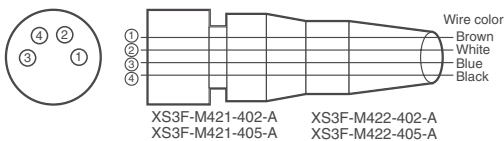

M12 4-wire Connectors

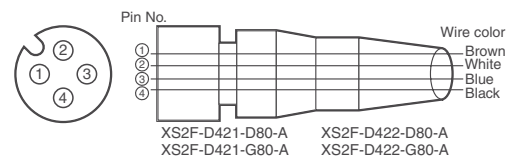

M12 3-wire Connectors

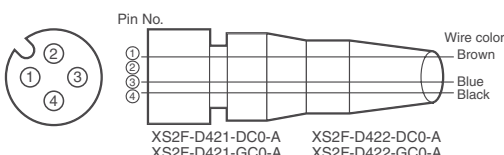

Classification	Wire color	Connector pin No.	Application
DC	Brown	①	Power supply (+V)
	White	②	Light emission stop input/operation selection
	Blue	③	Power supply (0 V)
	Black	④	Output

Note: The above M8 and M12 Connectors made by OMRON are IP67. Do not use in an environment where IP69K is required.

Nomenclature

Sensors with Sensitivity Adjustment and Mode Selector Switch

[Through-beam Models](#)

E3ZM-T□□ (Receiver)

[Retro-reflective Models](#)

E3ZM-R□□

[Diffuse-reflective Models](#)

E3ZM-D□□



Infinite Adjustment Emitter

[BGS Reflective Models](#)

E3ZM-LS□□H

[Through-beam Models](#)

E3ZM-T□□ (Emitter)



Safety Precautions

Refer to Warranty and Limitations of Liability on page 20.

Warning

This product is not designed or rated for ensuring safety of persons. Do not use it for such purpose.



Caution

Do not use the product with voltage in excess of the rated voltage. Excess voltage may result in malfunction or fire.



Never use the product with an AC power supply. Otherwise, explosion may result.



When cleaning the product, do not apply a concentrated spray of water to one location. Otherwise, parts may become damaged and the degree of protection may be degraded.



High-temperature environments may result in burn injury.



Precautions for Safe Use

The following precautions must be observed to ensure safe operation of the Sensor.

[Operating Environment](#)

Do not use the Sensor in an environment where explosive or flammable gas is present.

[Connecting Connectors](#)

Be sure to hold the connector cover when inserting or removing the connector. Be sure to tighten the connector lock by hand; do not use pliers or other tools. If the tightening is insufficient, the degree of protection will not be maintained and the Sensor may become loose due to vibration. The appropriate tightening torque is 0.3 to 0.4 N-m.

[Load](#)

Do not use a load that exceeds the rated load.

[Low-temperature Environments](#)

Do not touch the metal surface with your bare hands when the temperature is low. Touching the surface may result in a cold burn.

[Rotation Torque for Sensitivity Adjustment and Selector Switch](#)

Adjust with a torque of 0.06 N-m or less.

[Oily Environments](#)

Do not use the Sensor in oily environments.

[Modifications](#)

Do not attempt to disassemble, repair, or modify the Sensor.

[Outdoor Use](#)

Do not use the Sensor in locations subject to direct sunlight.

[Cleaning](#)

Do not use thinner, alcohol, or other organic solvents. Otherwise, the optical properties and degree of protection may be degraded.

[Washing](#)

Do not use highly concentrated detergents. They may cause malfunction. Do not use high-pressure water spray in excess of the specifications.

[Surface Temperature](#)

Burn injury may occur. The Sensor surface temperature rises depending on application conditions, such as the surrounding temperature and the power supply voltage. Use caution when operating or washing the Sensor.

Precautions for Safe Use

Do not install the Sensor in the following locations.

- (1) Locations subject to direct sunlight
- (2) Locations subject to condensation due to high humidity
- (3) Locations subject to corrosive gas
- (4) Locations where the Sensor may receive direct vibration or shock

Connecting and Mounting

- (1) The maximum power supply voltage is 30 VDC. Before turning the power ON, make sure that the power supply voltage does not exceed the maximum voltage.
- (2) Laying Sensor wiring in the same conduit or duct as high-voltage wires or power lines may result in malfunction or damage due to induction. As a general rule, wire the Sensor in a separate conduit or use shielded cable.
- (3) Use an extension cable with a minimum thickness of 0.3 mm² and less than 100 m long.
- (4) Do not pull on the cable with excessive force.
- (5) Pounding the Photoelectric Sensor with a hammer or other tool during mounting will impair water resistance. Also, use M3 screws.
- (6) Mount the Sensor either using the bracket (sold separately) or on a flat surface.
- (7) Be sure to turn OFF the power supply before inserting or removing the connector.

Cleaning

Never use thinner or other solvents. Otherwise, the Sensor surface may be dissolved.

Power Supply

If a commercial switching regulator is used, ground the FG (frame ground) terminal.

Power Supply Reset Time

The Sensor will be able to detect objects 100 ms after the power supply is turned ON. Start using the Sensor 100 ms or more after turning ON the power supply. If the load and the Sensor are connected to separate power supplies, be sure to turn ON the Sensor first.

Turning OFF the Power Supply

Output pulses may be generated even when the power supply is OFF. Therefore, it is recommended to first turn OFF the power supply for the load or the load line.

Load Short-circuit Protection

This Sensor is equipped with load short-circuit protection, but be sure to not short circuit the load. Be sure to not use an output current flow that exceeds the rated current. If a load short circuit occurs, the output will turn OFF, so check the wiring before turning ON the power supply again. The short-circuit protection circuit will be reset. The load shortcircuit protection will operate when the current flow reaches 1.8 times the rated load current. When using an L load, use an inrush current of 1.8 times the rated load current or higher.

Water Resistance

Do not use the Sensor in water, rainfall, or outdoors.

When disposing of the Sensor, treat it as industrial waste.

Mounting Diagram

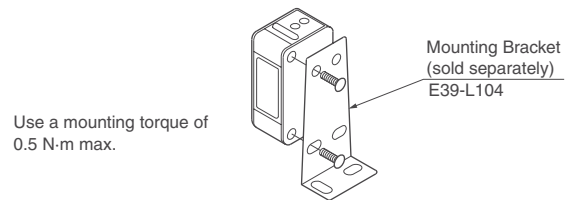

Resistance to Detergents, Disinfectants, and Chemicals

- Performance is assured for typical detergents and disinfectants, but performance may not be maintained for some detergents and disinfectants. Refer to the following table when using these agents.
- The E3ZM passed testing for resistance to detergents and disinfectants performed using the items in the following table. Refer to this table when considering use of detergents and disinfectants.

Category	Product name	Concentration	Temperature	Time
Chemical	Sodium hydroxide (NaOH)	1.5 %	70 °C	240 h
	Potassium hydroxide (KOH)	1.5 %	70 °C	240 h
	Phosphoric acid (H ₃ PO ₄)	2.5 %	70 °C	240 h
	Sodium hypochlorite (NaClO)	0.3 %	25 °C	240 h
	Hydrogen peroxide (H ₂ O ₂)	6.5 %	25 °C	240 h
Alkaline foam detergent	P3-topax-66s (Manufactured by Ecolab)	3.0 %	70 °C	240 h
Acidic foam detergent	P3-topax-56 (Manufactured by Ecolab)	5.0 %	70 °C	240 h
Disinfectant	P3-oxonia active 90 (Manufactured by Ecolab)	1.0 %	25 °C	240 h
	TEK121 (Manufactured by ABC Compounding)	1.1 %	25 °C	240 h

Note: The Sensor was immersed in the chemicals, detergents, and disinfectants listed above at the temperatures in the table for 240 hours and then passed an insulation resistance of 100 MΩ min.

Dimensions

Sensors

Through-beam Models

Pre-wired Models

E3ZM-T61(-G0)

E3ZM-T81(-G0)

E3ZM-T63(-G0)

E3ZM-T83(-G0)



Emitter

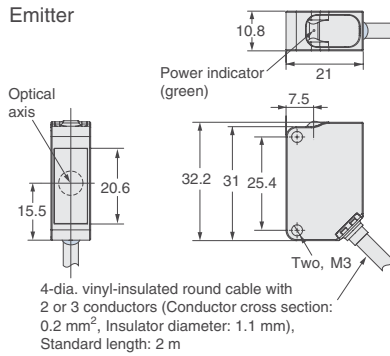

M12 Pre-wired Connector (E3ZM-□□□-M1J)

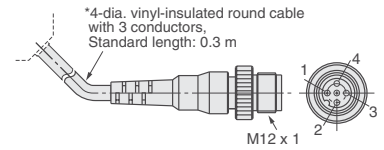

Terminal No.	Specifications
1	+V
2	Light emission stop input (-G0 only)
3	0V
4	---

Receiver

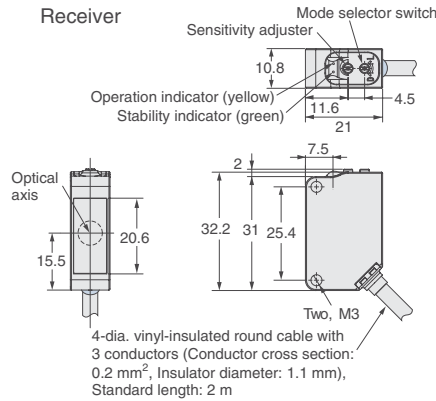

M12 Pre-wired Connector (E3ZM-□□□-M1J)

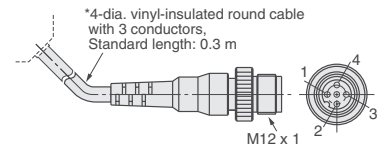

Terminal No.	Specifications
1	+V
2	---
3	0V
4	Output

Through-beam Models

Standard Connector

E3ZM-T66(-G0)

E3ZM-T86(-G0)

E3ZM-T68(-G0)

E3ZM-T88(-G0)



Receiver

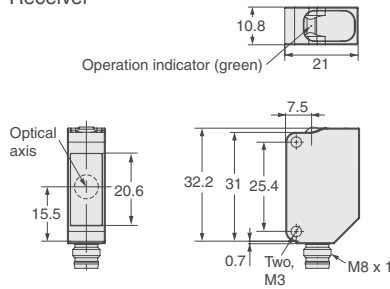

Terminal No.	Specifications
1	+V
2	Light emission stop input (-G0 only)
3	0V
4	---

Receiver

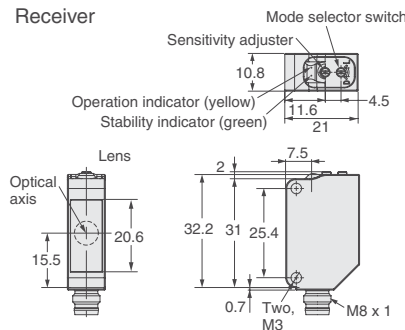

Terminal No.	Specifications
1	+V
2	---
3	0V
4	Output

Retro-reflective Models

Pre-wired Models

- E3ZM-R61
- E3ZM-R81

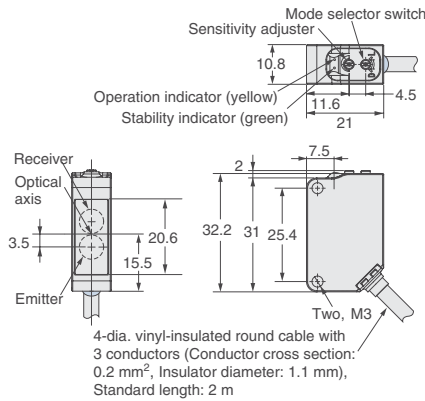

M12 Pre-wired Connector (E3ZM-□□□-M1J)

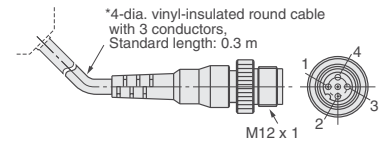

Terminal No.	Specifications
1	+V
2	---
3	0V
4	Output

Retro-reflective Models

Pre-wired Models

- E3ZM-R66
- E3ZM-R86

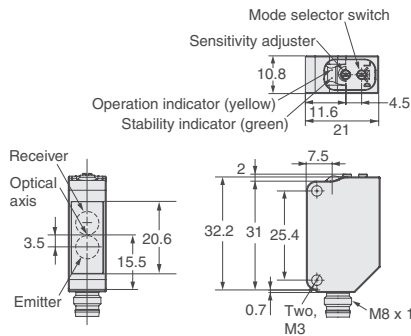

Terminal No.	Specifications
1	+V
2	---
3	0V
4	Output

Diffuse-reflective Models

Standard Connector

- E3ZM-D67
- E3ZM-D87

BGS Reflective Models

Pre-wired Models

- E3ZM-LS61H
- E3ZM-LS62H
- E3ZM-LS64H
- E3ZM-LS81H
- E3ZM-LS82H
- E3ZM-LS84H

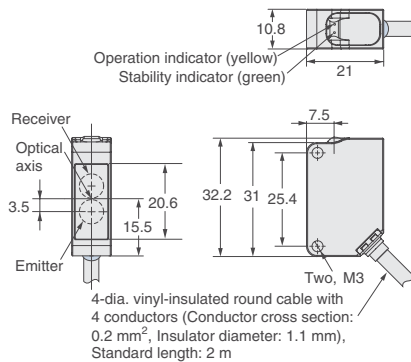

M12 Pre-wired Connector (E3ZM-□□□-M1J)

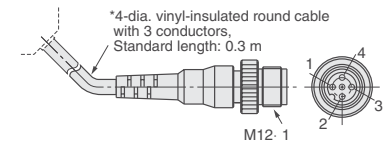

Terminal No.	Specifications
1	+V
2	Operation selection
3	0V
4	Output

BGS Reflective Models

Standard Connector

- E3ZM-LS66H
- E3ZM-LS67H
- E3ZM-LS69H
- E3ZM-LS86H
- E3ZM-LS87H
- E3ZM-LS89H

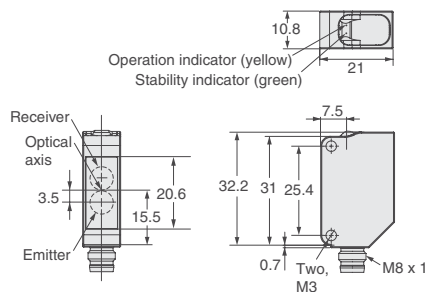

Terminal No.	Specifications
1	+V
2	Operation selection
3	0V
4	Output

WARRANTY

OMRON's exclusive warranty is that the products are free from defects in materials and workmanship for a period of one year (or other period if specified) from date of sale by OMRON.

OMRON MAKES NO WARRANTY OR REPRESENTATION, EXPRESS OR IMPLIED, REGARDING NON-INFRINGEMENT, MERCHANTABILITY, OR FITNESS FOR PARTICULAR PURPOSE OF THE PRODUCTS. ANY BUYER OR USER ACKNOWLEDGES THAT THE BUYER OR USER ALONE HAS DETERMINED THAT THE PRODUCTS WILL SUITABLY MEET THE REQUIREMENTS OF THEIR INTENDED USE. OMRON DISCLAIMS ALL OTHER WARRANTIES, EXPRESS OR IMPLIED.

LIMITATIONS OF LIABILITY

OMRON SHALL NOT BE RESPONSIBLE FOR SPECIAL, INDIRECT, OR CONSEQUENTIAL DAMAGES, LOSS OF PROFITS OR COMMERCIAL LOSS IN ANY WAY CONNECTED WITH THE PRODUCTS, WHETHER SUCH CLAIM IS BASED ON CONTRACT, WARRANTY, NEGLIGENCE, OR STRICT LIABILITY.

In no event shall responsibility of OMRON for any act exceed the individual price of the product on which liability is asserted.

IN NO EVENT SHALL OMRON BE RESPONSIBLE FOR WARRANTY, REPAIR, OR OTHER CLAIMS REGARDING THE PRODUCTS UNLESS OMRON'S ANALYSIS CONFIRMS THAT THE PRODUCTS WERE PROPERLY HANDLED, STORED, INSTALLED, AND MAINTAINED AND NOT SUBJECT TO CONTAMINATION, ABUSE, MISUSE, OR INAPPROPRIATE MODIFICATION OR REPAIR.

SUITABILITY FOR USE

THE PRODUCTS CONTAINED IN THIS DOCUMENT ARE NOT SAFETY RATED. THEY ARE NOT DESIGNED OR RATED FOR ENSURING SAFETY OF PERSONS, AND SHOULD NOT BE RELIED UPON AS A SAFETY COMPONENT OR PROTECTIVE DEVICE FOR SUCH PURPOSES. Please refer to separate catalogs for OMRON's safety rated products.

OMRON shall not be responsible for conformity with any standards, codes, or regulations that apply to the combination of products in the customer's application or use of the product.

At the customer's request, OMRON will provide applicable third party certification documents identifying ratings and limitations of use that apply to the products. This information by itself is not sufficient for a complete determination of the suitability of the products in combination with the end product, machine, system, or other application or use.

The following are some examples of applications for which particular attention must be given. This is not intended to be an exhaustive list of all possible uses of the products, nor is it intended to imply that the uses listed may be suitable for the products:

- Outdoor use, uses involving potential chemical contamination or electrical interference, or conditions or uses not described in this document.
- Nuclear energy control systems, combustion systems, railroad systems, aviation systems, medical equipment, amusement machines, vehicles, safety equipment, and installations subject to separate industry or government regulations.
- Systems, machines, and equipment that could present a risk to life or property.

Please know and observe all prohibitions of use applicable to the products.

NEVER USE THE PRODUCTS FOR AN APPLICATION INVOLVING SERIOUS RISK TO LIFE OR PROPERTY WITHOUT ENSURING THAT THE SYSTEM AS A WHOLE HAS BEEN DESIGNED TO ADDRESS THE RISKS, AND THAT THE OMRON PRODUCT IS PROPERLY RATED AND INSTALLED FOR THE INTENDED USE WITHIN THE OVERALL EQUIPMENT OR SYSTEM.

PERFORMANCE DATA

Performance data given in this document is provided as a guide for the user in determining suitability and does not constitute a warranty. It may represent the result of OMRON's test conditions, and the users must correlate it to actual application requirements. Actual performance is subject to the OMRON Warranty and Limitations of Liability.

CHANGE IN SPECIFICATIONS

Product specifications and accessories may be changed at any time based on improvements and other reasons.

It is our practice to change model numbers when published ratings or features are changed, or when significant construction changes are made. However, some specifications of the product may be changed without any notice. When in doubt, special model numbers may be assigned to fix or establish key specifications for your application on your request. Please consult with your OMRON representative at any time to confirm actual specifications of purchased products.

DIMENSIONS AND WEIGHTS

Dimensions and weights are nominal and are not to be used for manufacturing purposes, even when tolerances are shown.

ERRORS AND OMISSIONS

The information in this document has been carefully checked and is believed to be accurate; however, no responsibility is assumed for clerical, typographical, or proofreading errors, or omissions.

PROGRAMMABLE PRODUCTS

OMRON shall not be responsible for the user's programming of a programmable product, or any consequence thereof.

Cat. No. E369-E2-01-X

In the interest of product improvement, specifications are subject to change without notice.

OMRON EUROPE B.V.

Wegalaan 67-69,
NL-2132 JD, Hoofddorp,
The Netherlands
Phone: +31 23 568 13 00
Fax: +31 23 568 13 88
www.eu.omron.com
