

# LED Driver for High Power LEDs

## ILD4001

Step down LED Controller for high power LEDs

### Data Sheet

Revision 2.0, 2011-06-09

Industrial and Multimarket

**Edition 2011-06-09**

**Published by  
Infineon Technologies AG  
81726 Munich, Germany**

**© 2011 Infineon Technologies AG  
All Rights Reserved.**

### **Legal Disclaimer**

The information given in this document shall in no event be regarded as a guarantee of conditions or characteristics. With respect to any examples or hints given herein, any typical values stated herein and/or any information regarding the application of the device, Infineon Technologies hereby disclaims any and all warranties and liabilities of any kind, including without limitation, warranties of non-infringement of intellectual property rights of any third party.

### **Information**

For further information on technology, delivery terms and conditions and prices, please contact the nearest Infineon Technologies Office ([www.infineon.com](http://www.infineon.com)).

### **Warnings**

Due to technical requirements, components may contain dangerous substances. For information on the types in question, please contact the nearest Infineon Technologies Office.

Infineon Technologies components may be used in life-support devices or systems only with the express written approval of Infineon Technologies, if a failure of such components can reasonably be expected to cause the failure of that life-support device or system or to affect the safety or effectiveness of that device or system. Life support devices or systems are intended to be implanted in the human body or to support and/or maintain and sustain and/or protect human life. If they fail, it is reasonable to assume that the health of the user or other persons may be endangered.

### Revision History

Page or Item	Subjects (major changes since previous revision)
<b>Revision 2.0, 2011-06-09</b>	
All	Preliminary status removed
<b>Table 4</b>	DC characteristics updated
<b>Table 5</b>	Switching characteristics updated
<b>Chapter 6.4</b>	LED current vs $T_S$ added
<b>Revision 1.5, 2011-05-30</b>	
Table 2	ESD capability updated
Table 5	AC characteristics updated
Table 7	Analog dimming updated
Chapter 6.4	All figures updated

### Trademarks of Infineon Technologies AG

AURIX™, BlueMoon™, C166™, CanPAK™, CIPOS™, CIPURSE™, COMNEON™, EconoPACK™, CoolMOS™, CoolSET™, CORECONTROL™, CROSSAVE™, DAVE™, EasyPIM™, EconoBRIDGE™, EconoDUAL™, EconoPIM™, EiceDRIVER™, eupec™, FCOS™, HITFET™, HybridPACK™, I<sup>2</sup>RF™, ISOFACE™, IsoPACK™, MIPAQ™, ModSTACK™, my-d™, NovalithIC™, OmniTune™, OptiMOS™, ORIGATM™, PRIMARION™, PrimePACK™, PrimeSTACK™, PRO-SIL™, PROFET™, RASIC™, ReverSave™, SatRIC™, SIEGETM™, SINDRION™, SIPMOS™, SMARTi™, SmartLEWIS™, SOLID FLASH™, TEMPFET™, thinQ!™, TRENCHSTOP™, TriCore™, X-GOLD™, X-PMU™, XMM™, XPOSYS™.

### Other Trademarks

Advance Design System™ (ADS) of Agilent Technologies, AMBA™, ARM™, MULTI-ICE™, KEIL™, PRIMECELL™, REALVIEW™, THUMB™, μVision™ of ARM Limited, UK. AUTOSAR™ is licensed by AUTOSAR development partnership. Bluetooth™ of Bluetooth SIG Inc. CAT-iq™ of DECT Forum. COLOSSUS™, FirstGPS™ of Trimble Navigation Ltd. EMV™ of EMVCo, LLC (Visa Holdings Inc.). EPCOS™ of Epcos AG. FLEXGO™ of Microsoft Corporation. FlexRay™ is licensed by FlexRay Consortium. HYPERTERMINAL™ of Hilgraeve Incorporated. IEC™ of Commission Electrotechnique Internationale. IrDA™ of Infrared Data Association Corporation. ISO™ of INTERNATIONAL ORGANIZATION FOR STANDARDIZATION. MATLAB™ of MathWorks, Inc. MAXIM™ of Maxim Integrated Products, Inc. MICROTEC™, NUCLEUS™ of Mentor Graphics Corporation. Mifare™ of NXP. MIPI™ of MIPI Alliance, Inc. MIPS™ of MIPS Technologies, Inc., USA. muRata™ of MURATA MANUFACTURING CO., MICROWAVE OFFICE™ (MWO) of Applied Wave Research Inc., OmniVision™ of OmniVision Technologies, Inc. Openwave™ Openwave Systems Inc. RED HAT™ Red Hat, Inc. RFMD™ RF Micro Devices, Inc. SIRIUS™ of Sirius Satellite Radio Inc. SOLARIS™ of Sun Microsystems, Inc. SPANSION™ of Spansion LLC Ltd. Symbian™ of Symbian Software Limited. TAIYO YUDEN™ of Taiyo Yuden Co. TEAKLITE™ of CEVA, Inc. TEKTRONIX™ of Tektronix Inc. TOKO™ of TOKO KABUSHIKI KAISHA TA. UNIX™ of X/Open Company Limited. VERILOG™, PALLADIUM™ of Cadence Design Systems, Inc. VLYNQ™ of Texas Instruments Incorporated. VXWORKS™, WIND RIVER™ of WIND RIVER SYSTEMS, INC. ZETEX™ of Diodes Zetex Limited.

Last Trademarks Update 2010-10-26

## Table of Contents

	<b>Table of Contents</b> .....	4
	<b>List of Figures</b> .....	5
	<b>List of Tables</b> .....	6
<b>1</b>	<b>Features</b> .....	7
<b>2</b>	<b>Product Brief</b> .....	8
<b>3</b>	<b>Maximum Ratings</b> .....	10
<b>4</b>	<b>Thermal Characteristics</b> .....	11
<b>5</b>	<b>Electrical Characteristics</b> .....	12
5.1	DC Characteristics .....	12
5.2	Switching Characteristics .....	13
5.3	Digital Signals .....	14
<b>6</b>	<b>Basic Application Information</b> .....	15
6.1	External MOSFET .....	15
6.2	Setting the Average LED Current .....	15
6.3	Dimming of the LEDs .....	16
6.4	Switching Parameters .....	18
<b>7</b>	<b>Application Circuit</b> .....	24
<b>8</b>	<b>Evaluation Board</b> .....	24
<b>9</b>	<b>Package Information</b> .....	25

## List of Figures

Figure 1	Block Diagram	8
Figure 2	Total Power Dissipation vs. Soldering Point Temperature $T_S$	11
Figure 3	Analog Voltage Dimming (12V, 3 LEDs, $T_A=25^\circ\text{C}$ ) vs. $R_{\text{sense}}$	16
Figure 4	Analog Voltage Dimming (Relative) vs. $R_{\text{sense}}$	17
Figure 5	Analog Voltage Dimming vs. $T_A$ (12V, 3 LEDs, 110 m $\Omega$ , 47 $\mu\text{H}$ )	17
Figure 6	PWM Dimming: 3 dB Deviation of Contrast Ratio to Linear Dimming (12 V, 68 $\mu\text{H}$ , 3 LEDs)	18
Figure 7	Application Circuit	24
Figure 8	ILD4001 on Evaluation Board Using BSP318S	24
Figure 9	Package Outline SC74	25
Figure 10	Recommended PCB Footprint for Reflow Soldering	25
Figure 11	Tape Loading	25

## List of Tables

Table 1	Pin Definition and Function .....	9
Table 2	Maximum Ratings .....	10
Table 3	Maximum Thermal Resistance .....	11
Table 4	DC Characteristics .....	12
Table 5	Switching Characteristics .....	13
Table 6	Digital Control Parameter at Pin EN/PWM .....	14

## Step down LED Controller for high power LEDs

### 1 Features

- Wide input voltage range: 4.5 V ... 42 V
- Capable to drive N-channel MOSFETs that provide up to 3 A output current and up to 98% efficiency
- Temperature shut down mechanism
- Switching frequency up to 500 kHz
- Analog and PWM dimming possible
- Typical 3 % output current accuracy
- Very low LED current drift over temperature
- Minimum external component required
- Small package: SC-74

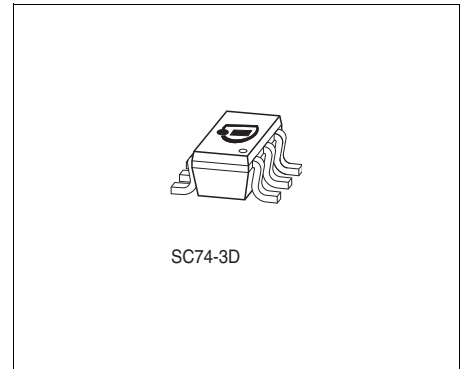

### Applications

- LED controller for indoor and outdoor illumination
- LED replacement lamps, e.g. MR16 halogen replacement
- Retail, office and residential high power luminaires
- Architectural lighting
- Downlights and light engines
- Appliances, e.g. fridge / freezer

Product Name	Package	Pin Configuration						Marking
ILD4001	SC74-6-4	1 = $V_S$	2 = GND	3 = EN	4 = $V_{drive}$	5 = GND	6 = $V_{sense}$	01

## 2 Product Brief

The ILD4001 is a hysteretic buck LED controller IC for driving high power LEDs in indoor and outdoor lighting applications.

The LED controller is capable of driving an external MOSFET power transistor with the internal push-pull output stage to achieve LED currents of 350 mA up to 3 A and more depending on the dimensioning of the MOSFET, the thermal budget of the circuit board and the current sense resistor.

The ILD4001 is widely suitable for LED applications with supply voltages up to 42 V. A multifunctional enable pin allows dimming of the LEDs with DC voltage or a PWM signal. Furthermore the enable pin can be used to switch the LED controller on and off to minimize power consumption in standby.

The ILD4001 incorporates an integrated thermal shutdown function pulling low the  $V_{drive}$  output signal once the junction temperature exceeds the threshold temperature. Once the junction temperature drops below the threshold temperature the  $V_{drive}$  output is activated again.

To provide maximum design flexibility, the ILD4001 is housed in a small SC-74 package.

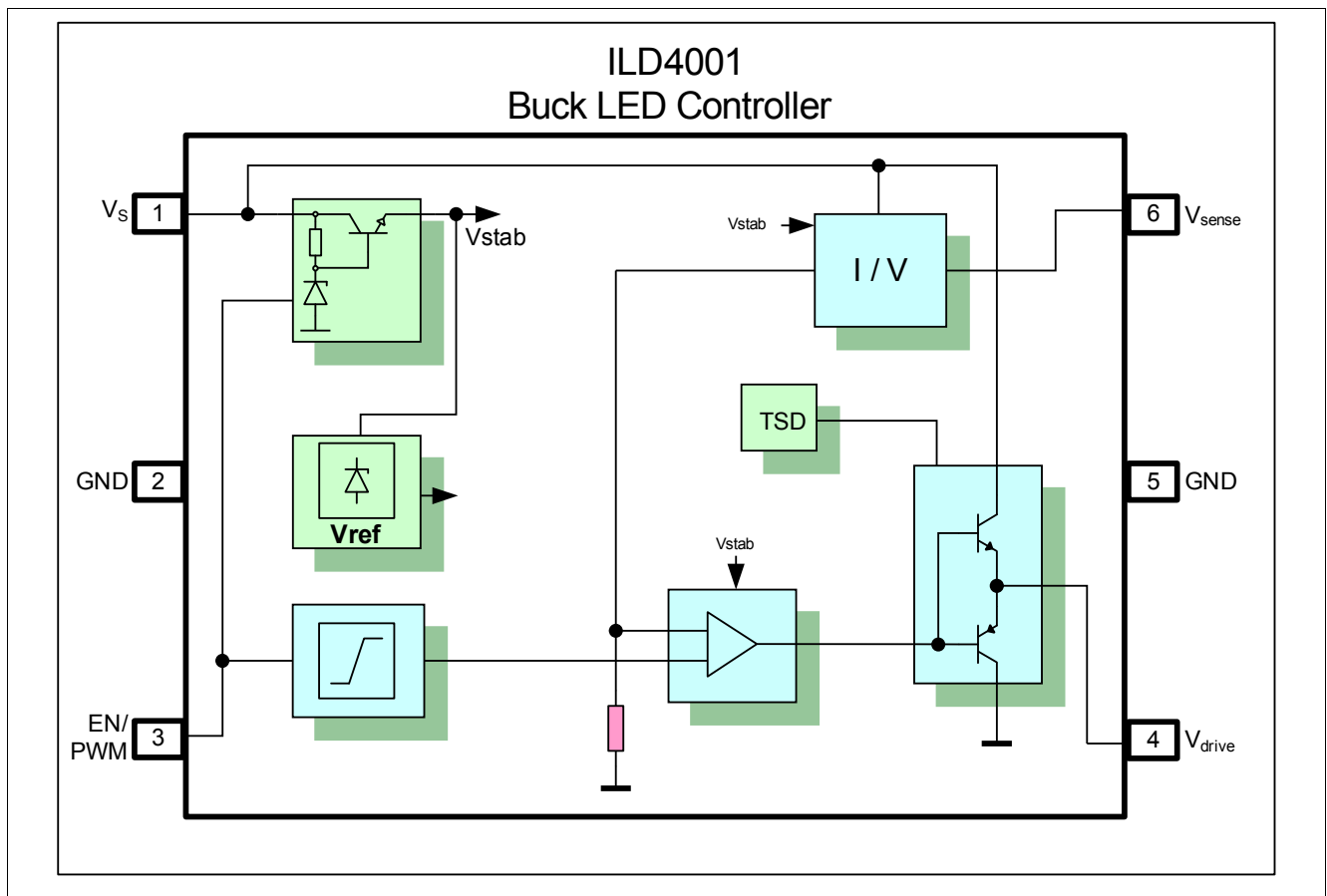

**Figure 1** Block Diagram



## Pin Definition

**Table 1 Pin Definition and Function**

Pin No.	Name	Pin Type	Buffer Type	Function
1	$V_s$	Input	–	Supply voltage
2	GND	GND	–	IC ground
3	EN / PWM	Input	–	Multifunctional pin: <ul style="list-style-type: none"><li>• Chip enable signal</li><li>• Analog dimming signal</li><li>• PWM dimming signal</li></ul>
4	$V_{drive}$	Output	–	Push-pull switch output pin
5	GND	GND	–	IC ground
6	$V_{sense}$	Input	–	LED current sense pin

### 3 Maximum Ratings

**Table 2** Maximum Ratings

Parameter	Symbol	Values			Unit	Note / Test Condition
		Min.	Typ.	Max.		
Supply voltage	$V_S$	–	–	45	V	–
Peak output current	$I_{drive}$	–	–	50	mA	–
Total power dissipation, $T_s \leq 115^\circ\text{C}$	$P_{tot}$	–	–	500	mW	–
Junction temperature	$T_J$	–	–	150	$^\circ\text{C}$	–
Solder temperature of GND pins	$T_{SGND}$	–	–	125	$^\circ\text{C}$	–
Storage temperature range	$T_{STG}$	-65	–	150	$^\circ\text{C}$	–
ESD capability at pin 4	$V_{ESD\ HBM}$	–	–	1	kV	HBM acc. to JESD22-A114
at all other pins		–	–	4		

**Attention:** Stresses above the max. values listed here may cause permanent damage to the device. Exposure to absolute maximum rating conditions for extended periods may affect device reliability. Maximum ratings are absolute ratings; exceeding only one of these values may cause irreversible damage to the integrated circuit.

## 4 Thermal Characteristics

**Table 3** Maximum Thermal Resistance

Parameter	Symbol	Values			Unit	Note / Test Condition
		Min.	Typ.	Max.		
Junction - soldering point <sup>1)</sup>	$R_{thJS}$	–	–	70	K/W	–

1) For calculation of  $R_{thJA}$  please refer to application note AN077, "Thermal Resistance Calculation"

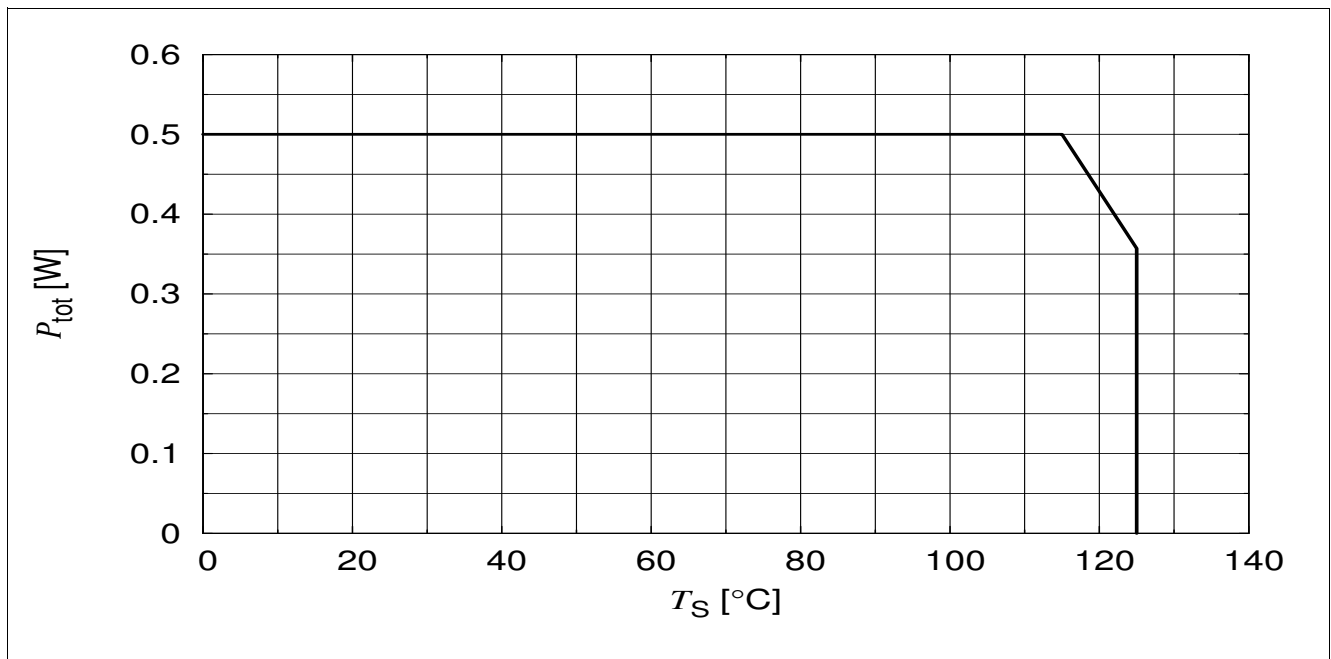

**Figure 2** Total Power Dissipation vs. Soldering Point Temperature  $T_S$

**Equation (1)** is a first estimation to calculate the power dissipation of the IC:

$$P_{tot} = V_S \cdot I_S + f_{Switch} \cdot C_{drive} \cdot V_S \cdot 5V \quad (1)$$

## 5 Electrical Characteristics

### 5.1 DC Characteristics

All parameters at  $T_A = 25\text{ }^\circ\text{C}$ ,  $V_S = 12\text{ V}$ ,  $V_{EN} = 3\text{ V}$ , unless otherwise specified.

**Table 4 DC Characteristics**

Parameter	Symbol	Values			Unit	Note / Test Condition
		Min.	Typ.	Max.		
Supply voltage	$V_S$	4.5	–	42	V	–
Overall current consumption open load	$I_{S\ open\ load}$	–	4.2	–	mA	$V_S = 4.5\text{ V}$ , $I_{LED} = 0\text{ mA}$
Overall current consumption open load	$I_{S\ open\ load}$	–	5.1	–	mA	$V_S = 40\text{ V}$ , $I_{LED} = 0\text{ mA}$
Overall current consumption open load	$I_{S\ open\ load}$	–	5.3	–	mA	$V_S = 42\text{ V}$ , $I_{LED} = 0\text{ mA}$
Overall standby current consumption	$I_{S\ standby}$	–	–	260	nA	$V_S = 4.5\text{ V}$ , $V_{EN} = 0.4\text{ V}$
Overall standby current consumption	$I_{S\ standby}$	–	–	360	nA	$V_S = 40\text{ V}$ , $V_{EN} = 0.4\text{ V}$
Enable voltage for standby mode <sup>1)</sup>	$V_{EN}$	0	–	0.4	V	
Enable voltage for analog dimming <sup>2)</sup>	$V_{EN}$	1	–	42	V	
Enable voltage for linear analog dimming	$V_{EN}$	1	–	2	V	linear dimming range
Input current of multifunctional control pin	$I_{EN}$	–	150	270	$\mu\text{A}$	$V_{EN} = 3\text{ V}$
Current of Sense input	$I_{sense}$	–	20	–	$\mu\text{A}$	At any LED current
Temperature shut down threshold	$T_{TSD}$	–	120	–	$^\circ\text{C}$	$V_{drive}$ gets pulled low, refers to $T_J$

- 1) In standby mode ILD4001 doesn't pull low the  $V_{drive}$  signal. Depending on gate capacitance driven a 10 - 100 k $\Omega$  shunt resistor to GND is required to avoid a floating gate of the MOSFET. A discharge time of about 1  $\mu\text{s}$  is recommended.
- 2)  $V_{drive}$  line requires a shunt resistor to GND to avoid a floating gate of the MOSFET for a  $V_{EN}$  voltage below the min. specified limit

## 5.2 Switching Characteristics

All parameters at  $T_A = 25\text{ °C}$ , unless otherwise specified.

$V_S = 12\text{ V}$ ,  $R_{\text{sense}} = 158\text{ m}\Omega$  ( $I_{\text{LED}} = 730\text{ mA}$ ),  $L = 68\text{ }\mu\text{H}$ ,  $V_{\text{EN}} = 3\text{ V}$

**Table 5 Switching Characteristics**

Parameter	Symbol	Values			Unit	Note / Test Condition
		Min.	Typ.	Max.		
Switching frequency	$f_{\text{Switch}}$	–	200	–	kHz	3 LEDs in series
Maximum switching frequency	$f_{\text{Switch max}}$	–		500	kHz	for any coil value
Output voltage in push-high condition	$V_{\text{drive\_high}}$	–	5	–	V	$I_{\text{drive}} = 10\text{ mA}$
Output voltage in pull-low condition	$V_{\text{drive\_low}}$	–	250	–	mV	$I_{\text{drive}} = -10\text{ mA}$
Voltage offset of $V_{\text{sense}}$ input <sup>1)</sup>	$V_{\text{sense}}$	–	116	–	mV	3 LEDs in series, $V_S - V_{\text{fLED}} \geq 3\text{ V}$
Sense threshold hysteresis	$V_{\text{sense hys}}$	–	$\pm 15$	–	%	At any LED current
Output current accuracy	$I_{\text{outacc}}$	–	$\pm 3$	–	%	3 LEDs in series
Output current drift over supply voltage	$I_{\text{outaccVs}}$	–	6	–	%	3 LEDs in series $V_S = 12 \dots 42\text{ V}$

1) Voltage offset below supply voltage  $V_S$

### 5.3 Digital Signals

All parameters at  $T_A = 25\text{ °C}$ , unless otherwise specified.

**Table 6 Digital Control Parameter at Pin EN/PWM**

Parameter	Symbol	Values			Unit	Note / Test Condition
		Min.	Typ.	Max.		
Input voltage for power on	$V_{On}$	2.5	3	42	V	Full LED current
Input voltage for power off <sup>1)</sup>	$V_{Off}$	-0.3	–	0.4	V	–
Min. power on puls duration	$t_{On}$	10			μs	

1) During power off ILD4001 doesn't pull low the  $V_{drive}$  signal. Depending on gate capacitance driven a 10 - 100 kΩ shunt resistor to GND is required to avoid a floating gate of the MOSFET. A discharge time of about 1 μs is recommended.

## 6 Basic Application Information

This section covers the basic information required for calculating the parameters for a certain LED application.

For detailed application information please check the application note **AN213** (Driving 2 - 5 W LEDs with ILD4001) or visit our web site <http://www.infineon.com/lowcostledrivers>

### 6.1 External MOSFET

An external MOSFET is required to drive the LEDs in the ILD4001 application. There are a few factors to be considered while choosing the suitable external MOSFET. First, choose the correct voltage and current rating of the MOSFET. Please ensure the  $V_{DS}$  breakdown voltage and  $I_{DS}$  current capability is sufficient and ensure that the external MOSFET is working within the safe operating area region of DC mode. Second, the logic high level from ILD4001 is 5 V and the external MOSFET must be able to be driven with a 5 V gate voltage. Third, choose a low  $R_{DS(ON)}$  MOSFET to improve the efficiency of the system.

The BSR302N is recommended for supply voltages up to 30 V and an output current up to 3.7 A. For higher supply voltages up to 42 V, the BSP318S is recommended with an output current of up to 2.6 A.

For an overview of all suitable MOSFETs please visit <http://www.infineon.com/smallsignalmosfets>

### 6.2 Setting the Average LED Current

The average output current for the LEDs is set by the external sense resistor  $R_{sense}$ . To calculate the value of this resistor a first approximation can be calculated using [Equation \(2\)](#).

$V_{sense}$  is dependent on the supply voltage  $V_s$  and the number of LEDs in series.

$$R_{sense} = \frac{V_{sense}}{I_{LED}} \tag{2}$$

#### Example Calculation

$V_s = 12\text{ V}$ ,  $I_{LED} = 730\text{ mA}$ ,  $L = 68\text{ }\mu\text{H}$ ,  $V_{fLED} = 3\text{ V}$ , 3 LEDs in series

For this configuration  $V_{sense}$  will settle at 116 mV.

→  $R_{sense} = 158\text{ m}\Omega$  according to [Equation \(2\)](#)

An easy way to achieve this resistor value is to connect several standard resistors in parallel.

### 6.3 Dimming of the LEDs

#### Analog Voltage Dimming

The voltage level of the EN/PWM pin can be used for analog dimming of the LED current. The analog dimming characteristic graph is shown in [Figure 3](#). To achieve a linear change in LED current versus control voltage the recommended voltage range at the EN/PWM pin is 1 V to 2 V. The maximum achievable LED current is defined by resistor  $R_{sense}$ . The maximum LED current will be achieved for  $V_{EN} \geq 2.5$  V as shown in [Figure 4](#).

Below 0.4 V the ILD4001 is set to standby mode and the output is switched off. In standby mode ILD4001 doesn't pull low the  $V_{drive}$  output signal driving the gate of the external MOSFET. Depending on gate capacitance driven a 10 - 100 k $\Omega$  shunt resistor to GND is required to avoid a floating gate of the MOSFET. Furthermore a gate discharge time of about 1  $\mu$ s is recommended.

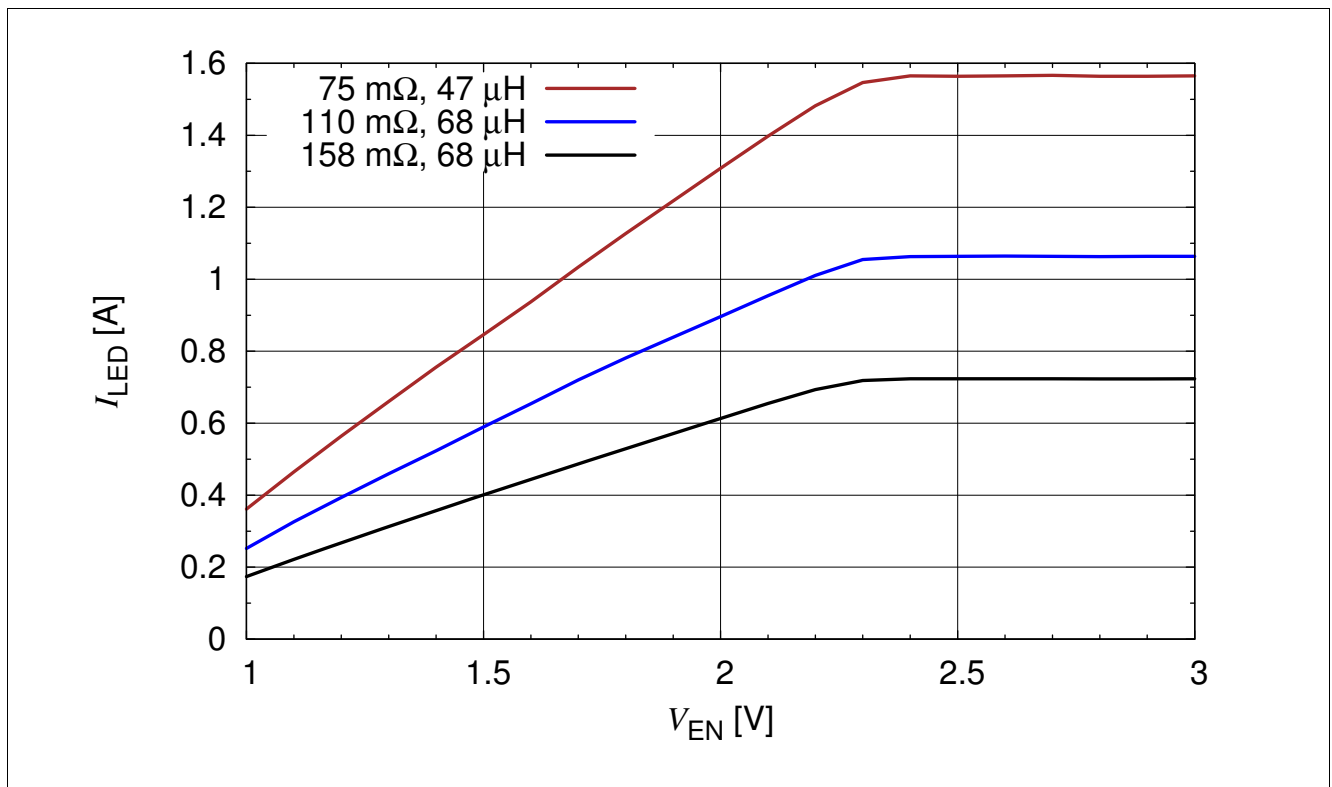

**Figure 3** Analog Voltage Dimming (12V, 3 LEDs,  $T_A=25^\circ\text{C}$ ) vs.  $R_{sense}$



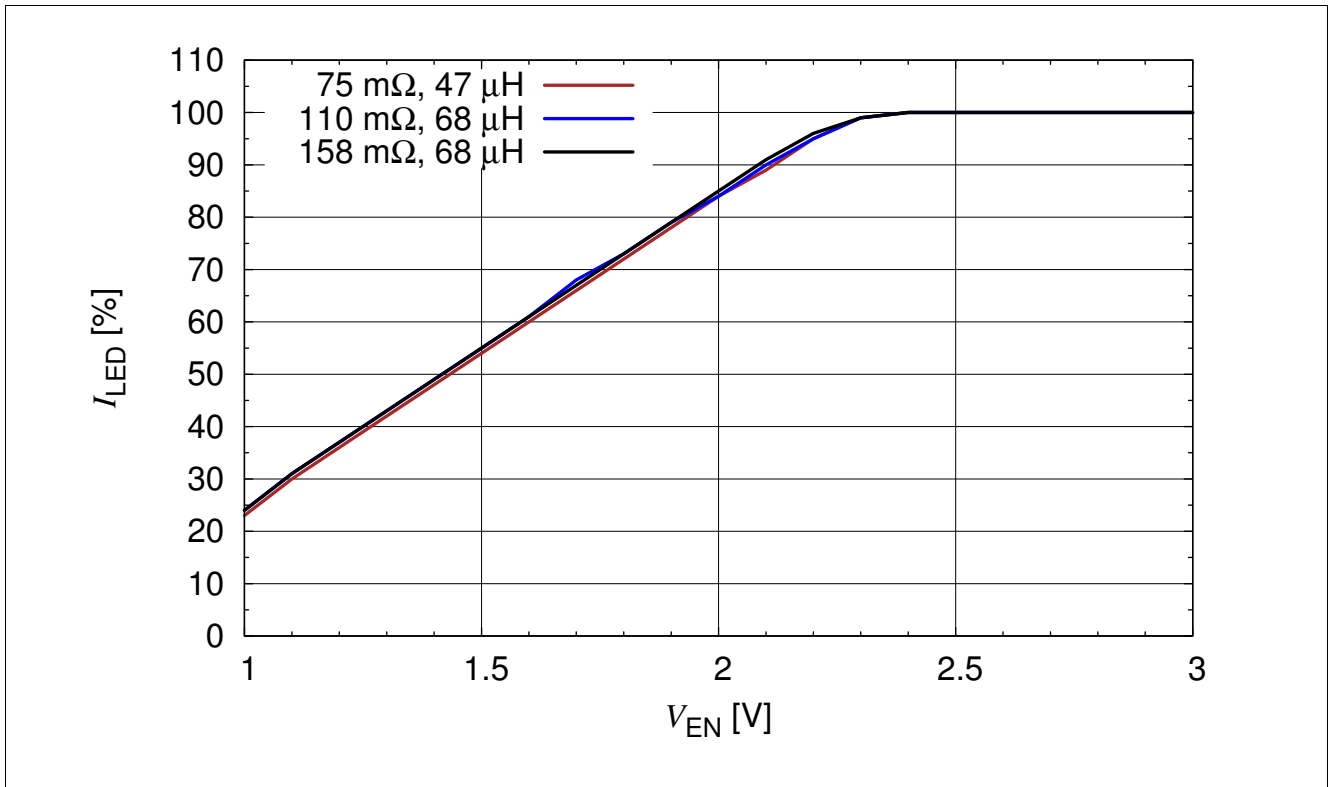

Figure 4 Analog Voltage Dimming (Relative) vs.  $R_{sense}$

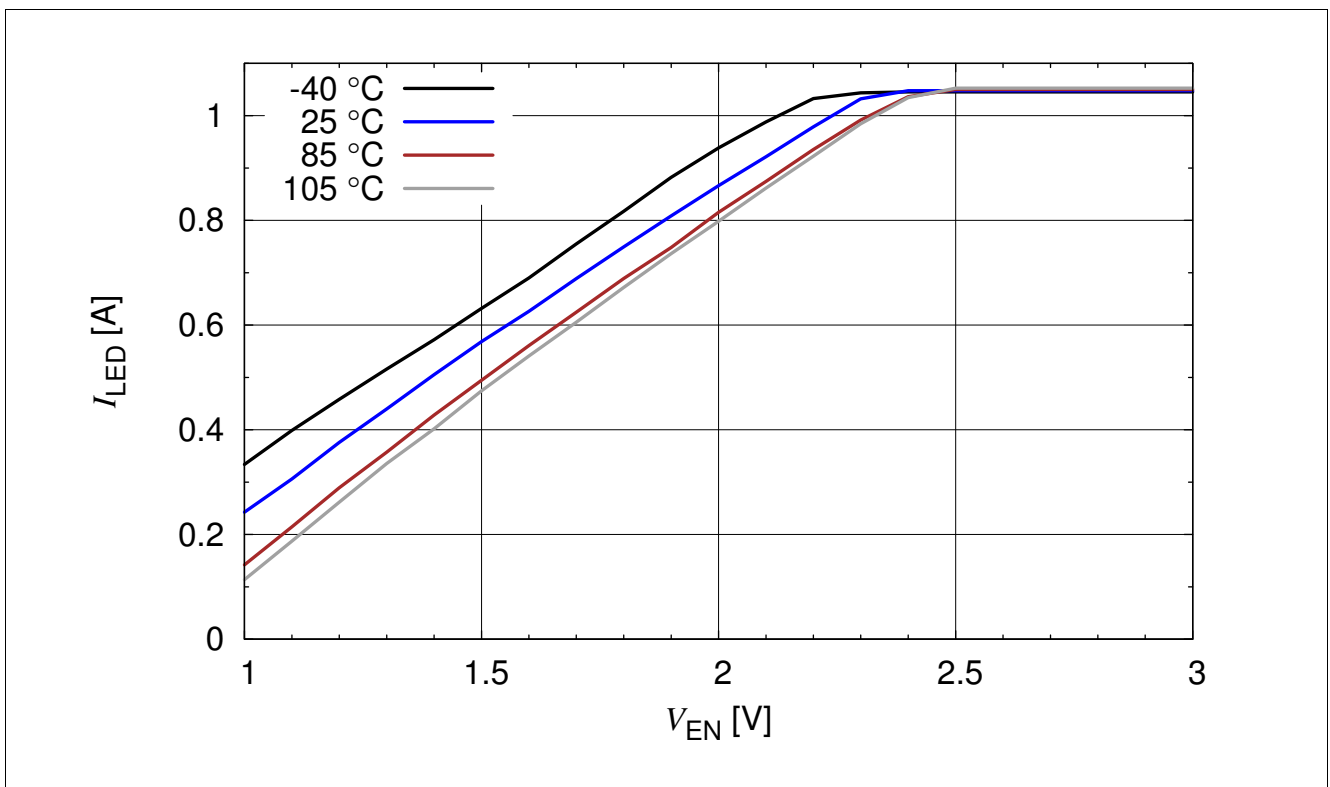
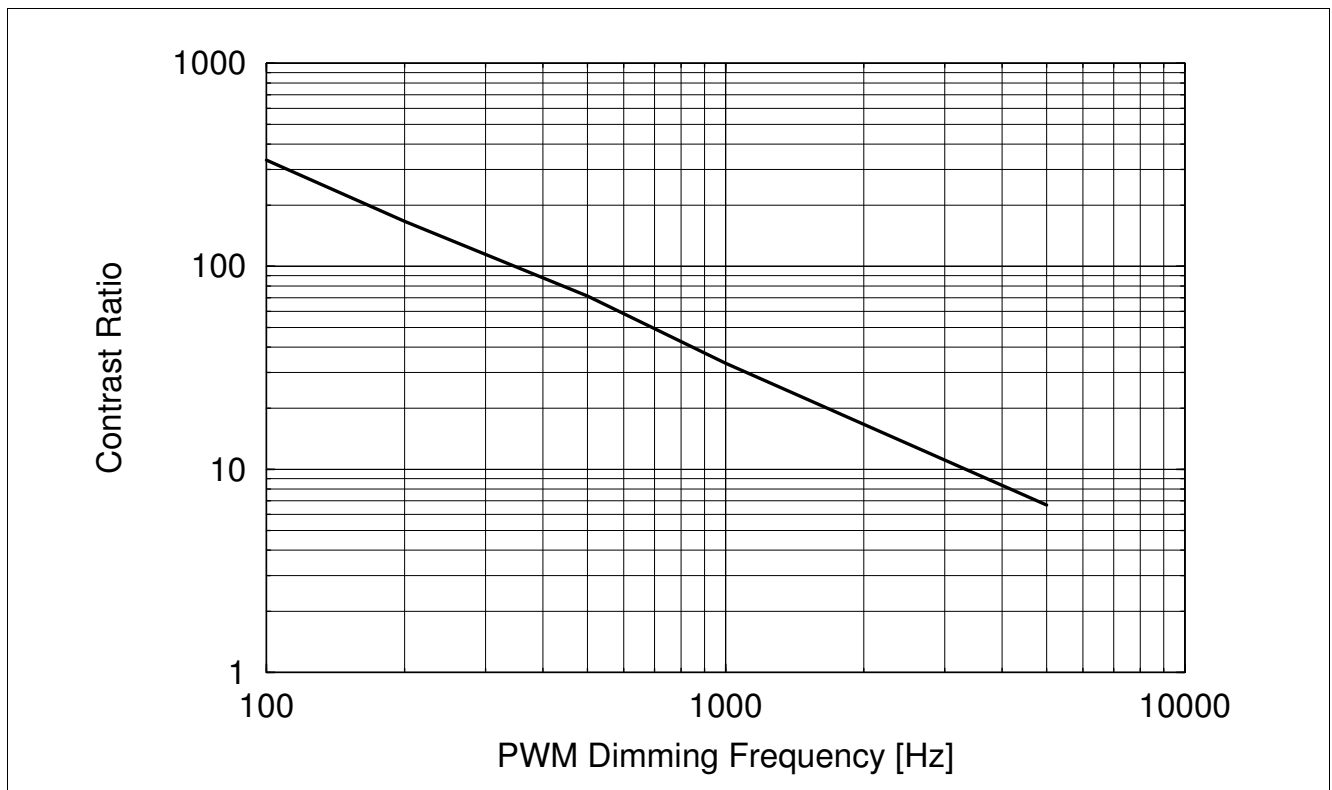

Figure 5 Analog Voltage Dimming vs.  $T_A$  (12V, 3 LEDs, 110 mΩ, 47 μH)

### PWM Dimming

Besides the analog dimming functionality the EN/PWM pin acts as input for a pulse width modulated (PWM) signal to control the dimming of the LED string. For PWM dimming the signal's logic high level should be at least 2.5 V and the PWM frequency should be lower than 5 kHz. For the ILD4035/4001 demo board a dimming frequency less than 330 Hz is recommended to maintain a maximum contrast ratio of 100:1. The achievable contrast ratio is shown on **Figure 6** based on the measured average LED current deviating 3 dB from the linear reference. The maximum contrast ratio depends mainly on the rise time of the inductor current and is thus dependent on supply voltage, inductor size and LED string forward voltage.



**Figure 6 PWM Dimming: 3 dB Deviation of Contrast Ratio to Linear Dimming (12 V, 68  $\mu$ H, 3 LEDs)**

During the low state of the PWM signal ILD4001 doesn't pull low the  $V_{drive}$  signal. Depending on gate capacitance driven and intended gate discharge time (about 1  $\mu$ s is recommended) a 10 - 100 k $\Omega$  shunt resistor to GND is required to avoid a floating gate of the MOSFET.

### 6.4 Switching Parameters

For all shown switching parameters ILD4001 has been measured on evaluation board ILD4035/4001 using a BSP318S N-channel MOSFET at  $T_A = 25$  °C. Used LEDs have a typical  $V_{fLED}$  of 3 V. See application note **AN213** for further details.

Performance vs. supply voltage and number of LEDs:  $R_{sense} = 75\text{ m}\Omega$ ,  $L = 33\text{ }\mu\text{H}$ ,  $V_{fLED} = 3\text{ V}$

$I_{LED}$  versus  $V_S$  and Number of LEDs

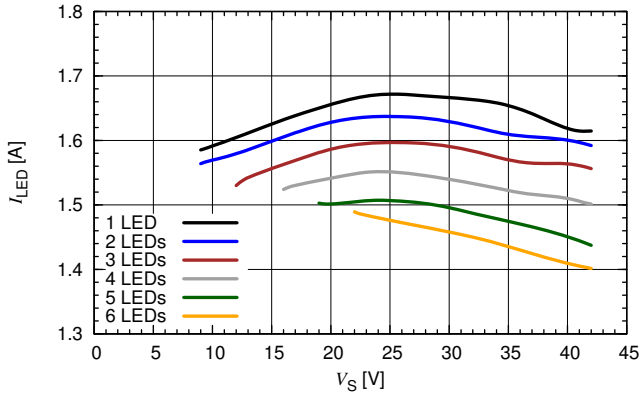

$f_{Switch}$  versus  $V_S$  and Number of LEDs

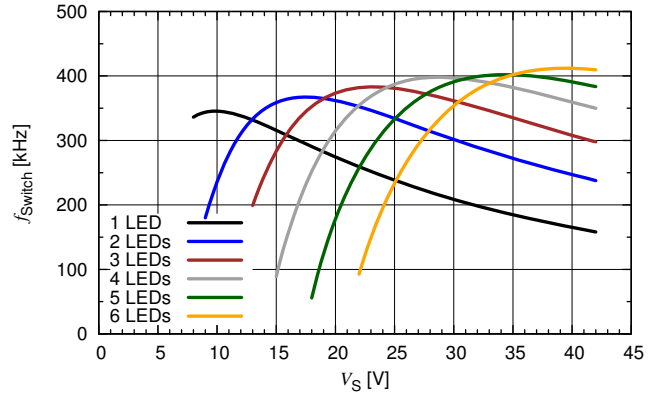

Efficiency versus  $V_S$  and Number of LEDs

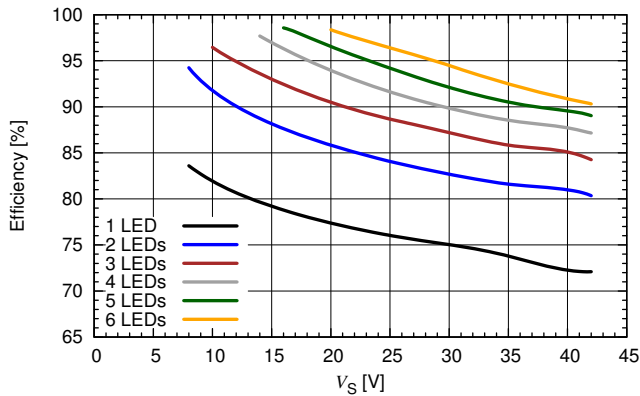

Duty Cycle versus  $V_S$  and Number of LEDs

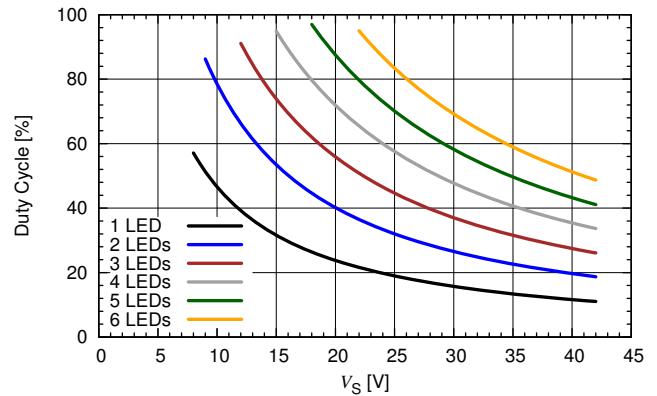

Performance vs. supply voltage and number of LEDs:  $R_{\text{sense}} = 75 \text{ m}\Omega$ ,  $L = 47 \text{ }\mu\text{H}$ ,  $V_{\text{fLED}} = 3 \text{ V}$

$I_{\text{LED}}$  versus  $V_{\text{S}}$  and Number of LEDs

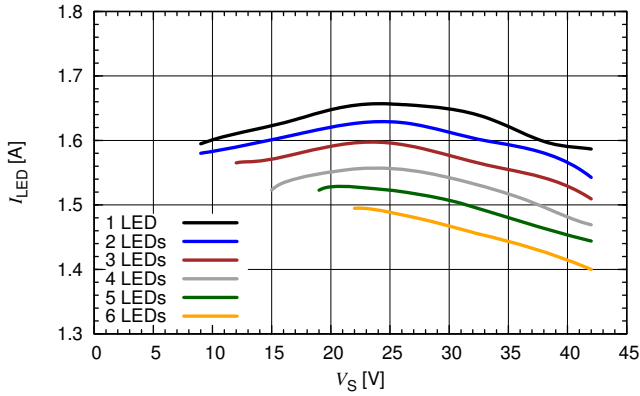

$f_{\text{Switch}}$  versus  $V_{\text{S}}$  and Number of LEDs

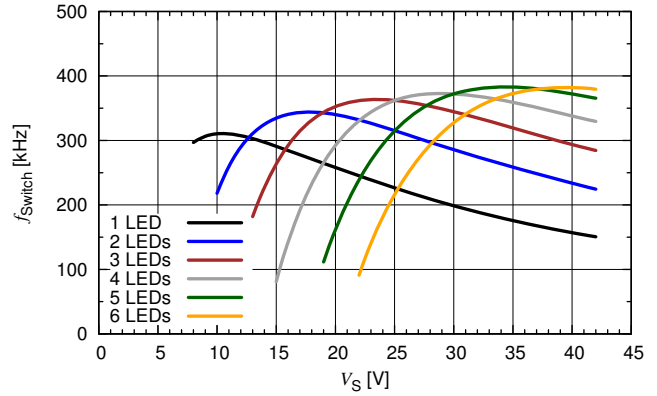

Efficiency versus  $V_{\text{S}}$  and Number of LEDs

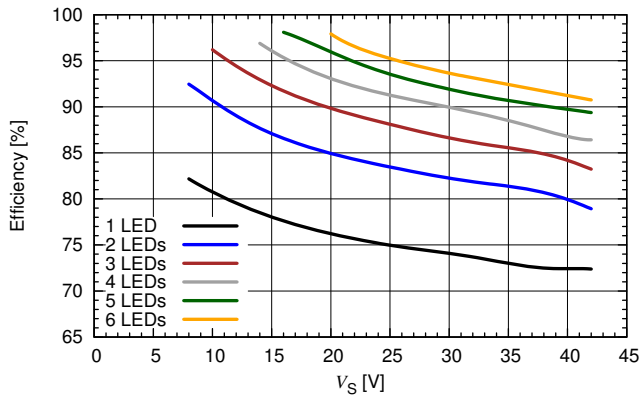

Duty Cycle versus  $V_{\text{S}}$  and Number of LEDs

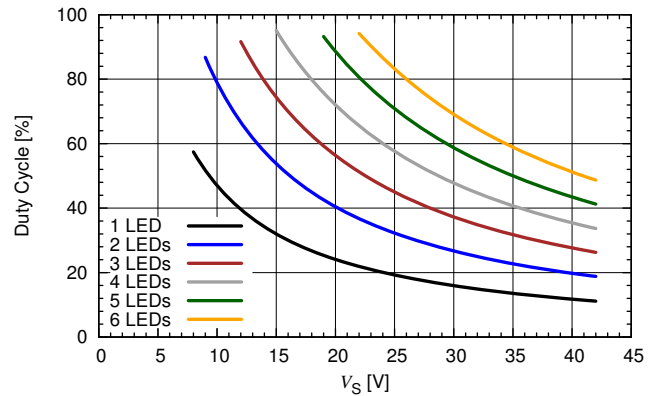

Performance vs. supply voltage and number of LEDs:  $R_{sense} = 158\text{ m}\Omega$ ,  $L = 47\text{ }\mu\text{H}$ ,  $V_{fLED} = 3\text{ V}$

$I_{LED}$  versus  $V_S$  and Number of LEDs

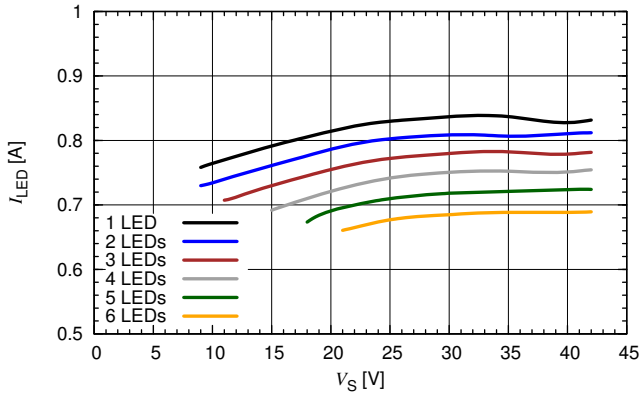

$f_{Switch}$  versus  $V_S$  and Number of LEDs

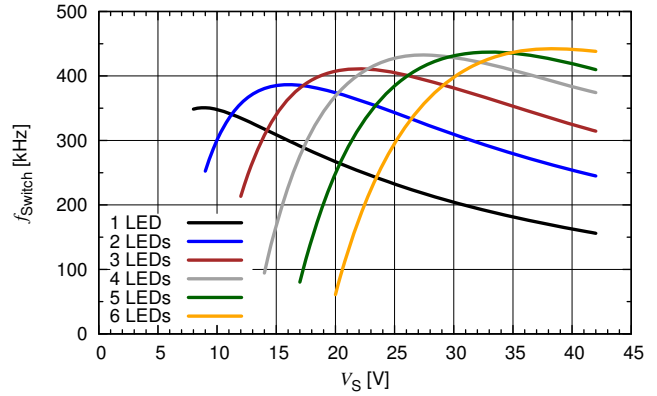

Efficiency versus  $V_S$  and Number of LEDs

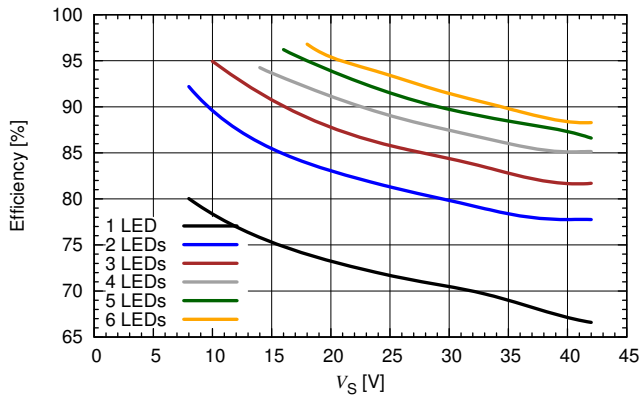

Duty Cycle versus  $V_S$  and Number of LEDs

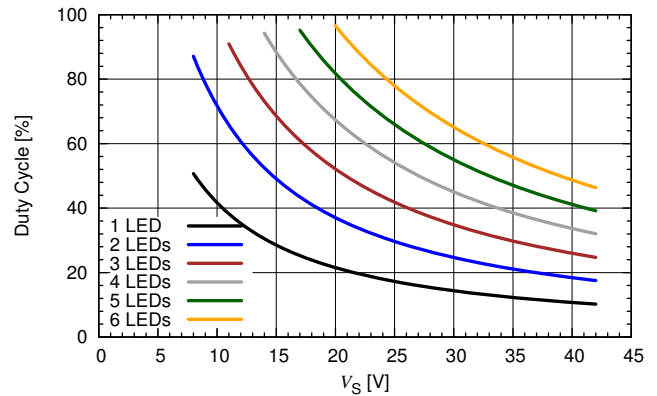

Performance vs. supply voltage and number of LEDs:  $R_{sense} = 158\text{ m}\Omega$ ,  $L = 68\text{ }\mu\text{H}$ ,  $V_{fLED} = 3\text{ V}$

$I_{LED}$  versus  $V_S$  and Number of LEDs

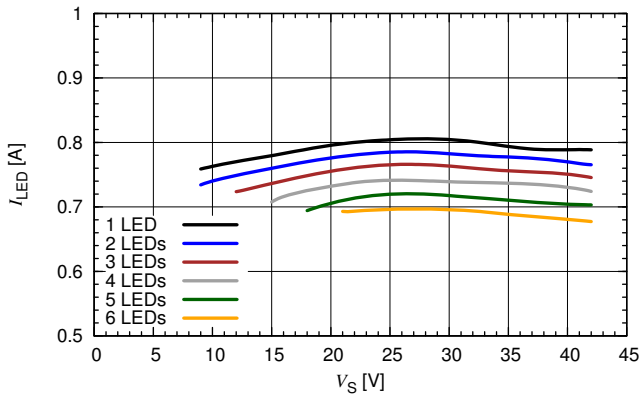

$f_{Switch}$  versus  $V_S$  and Number of LEDs

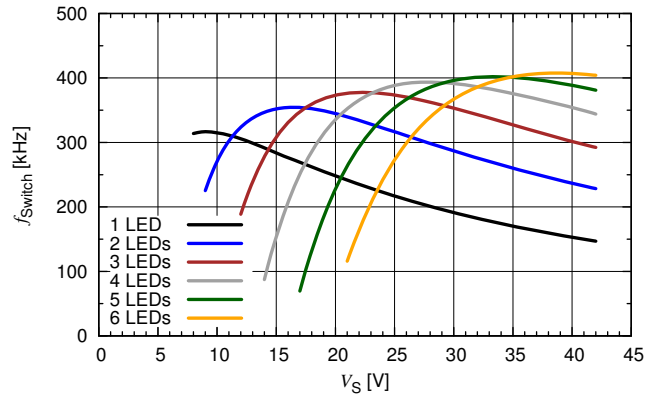

Efficiency versus  $V_S$  and Number of LEDs

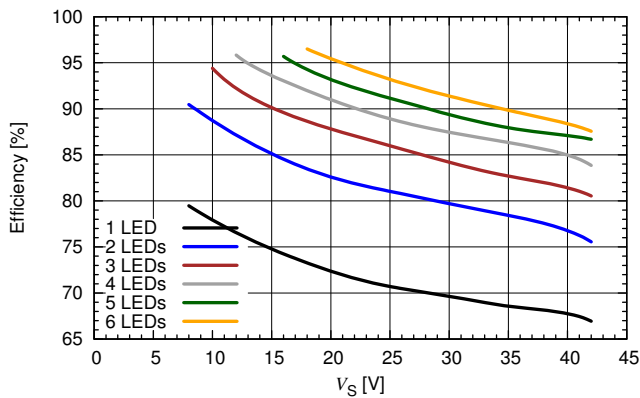

Duty Cycle versus  $V_S$  and Number of LEDs

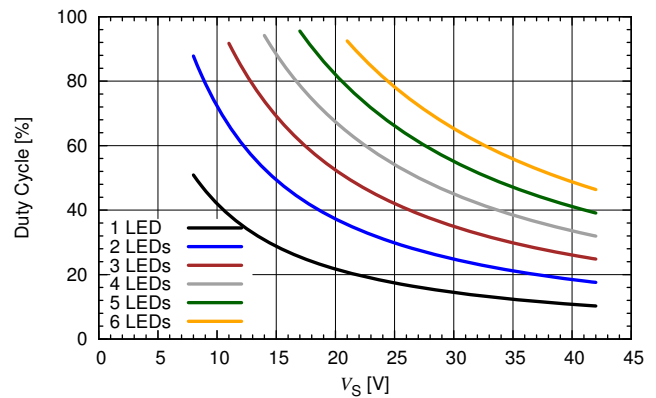

LED current vs. soldering point temperature  $T_S$  ( $V_S = 12V$ ,  $V_{fLED} = 3 V$ , 3 LEDs)

$I_{LED}$  versus  $T_S$  ( $R_{sense} = 75 m\Omega$ ,  $L = 47 \mu H$ )

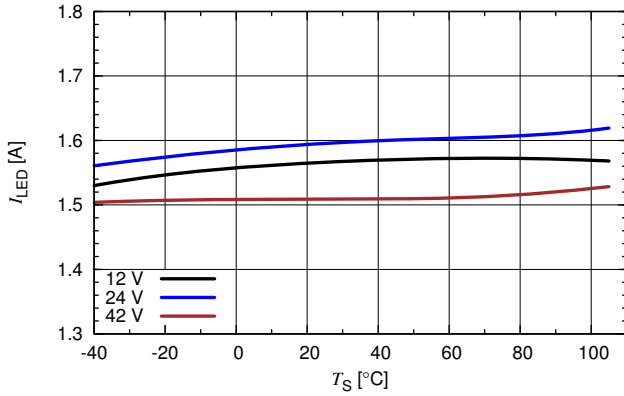

$I_{LED}$  versus  $T_S$  ( $R_{sense} = 110 m\Omega$ ,  $L = 68 \mu H$ )

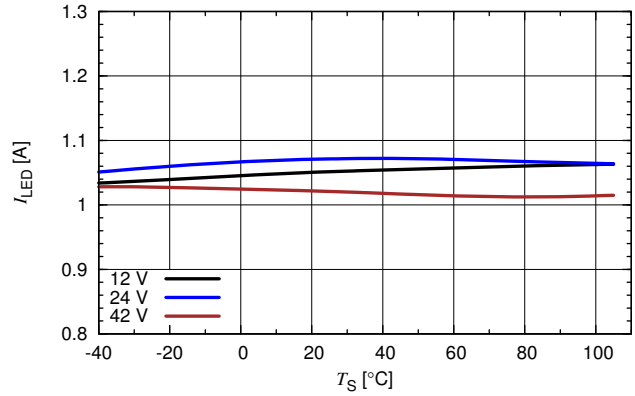

$I_{LED}$  versus  $T_S$  ( $R_{sense} = 158 m\Omega$ ,  $L = 68 \mu H$ )

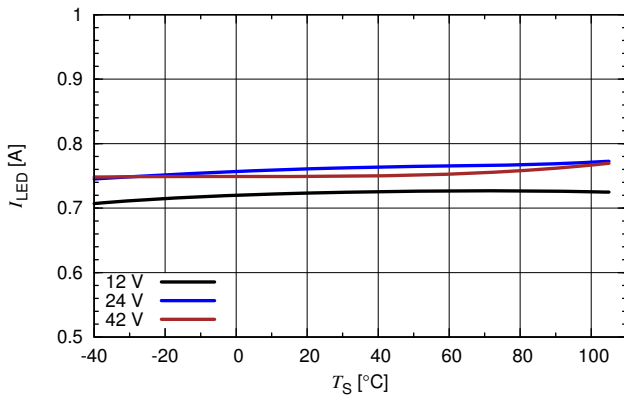

## 7 Application Circuit

For detailed application information please check the Application Note **AN213** (Driving 2 - 5 W LEDs with ILD4001) or visit our web site <http://www.infineon.com/lowcostleddrivers>

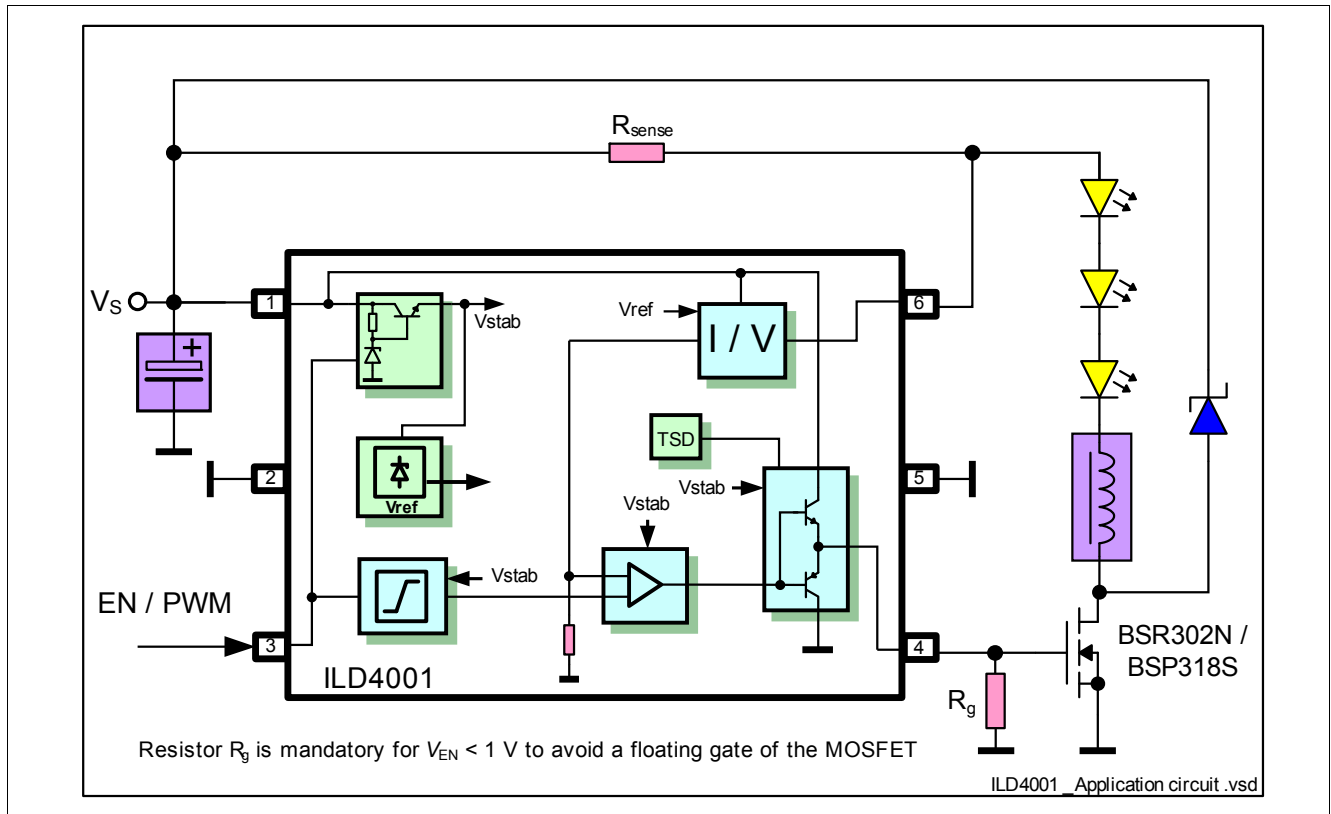

Figure 7 Application Circuit

## 8 Evaluation Board

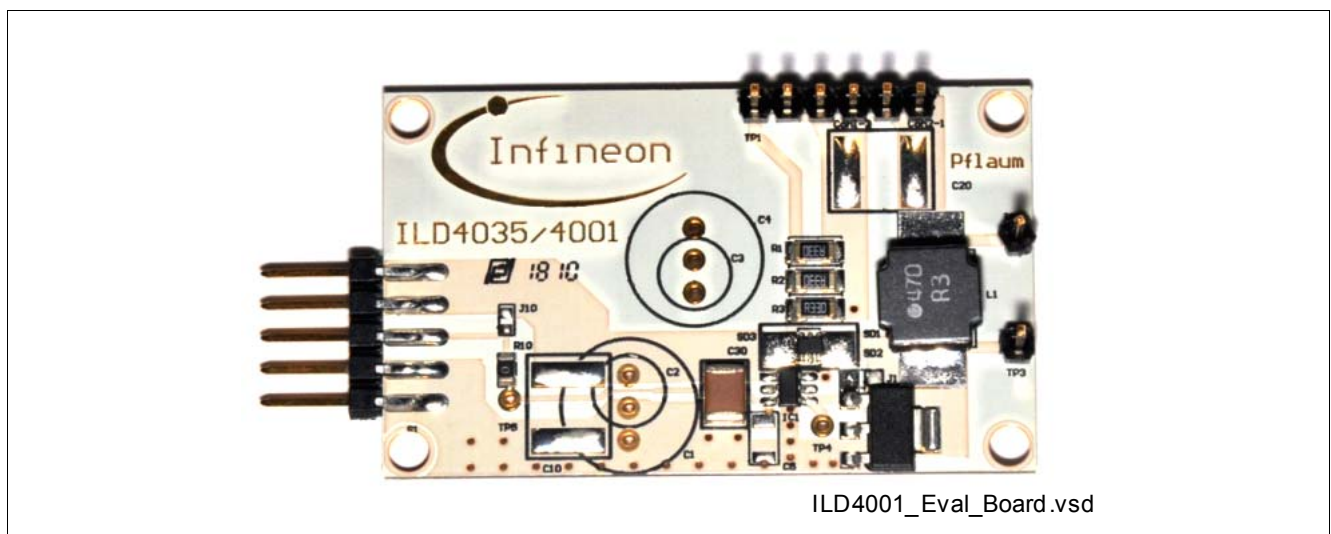

Figure 8 ILD4001 on Evaluation Board Using BSP318S



## 9 Package Information

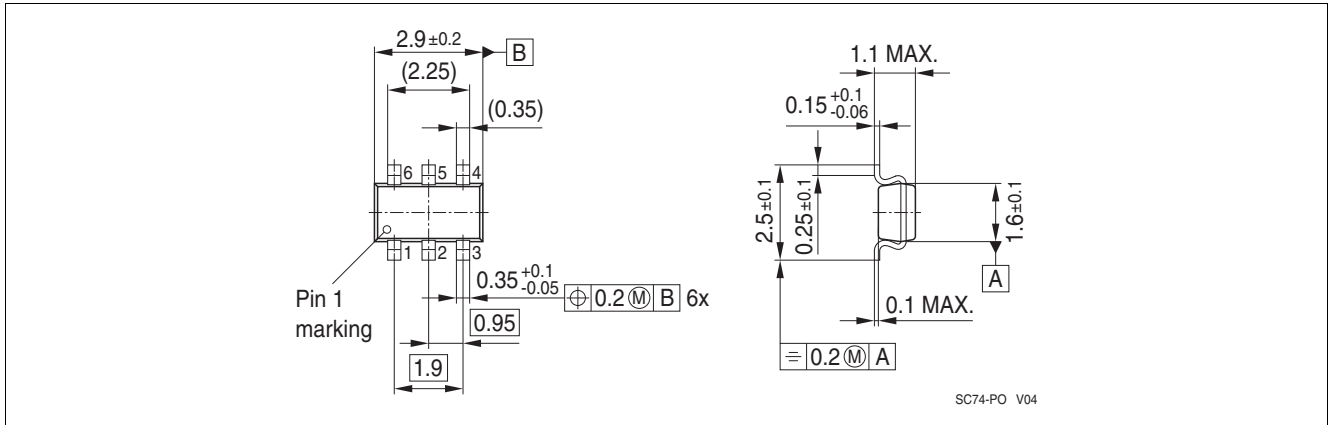

Figure 9 Package Outline SC74

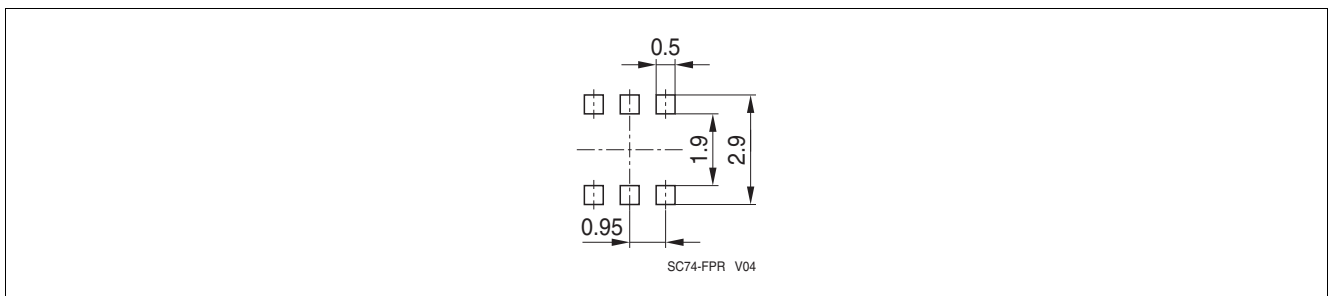

Figure 10 Recommended PCB Footprint for Reflow Soldering

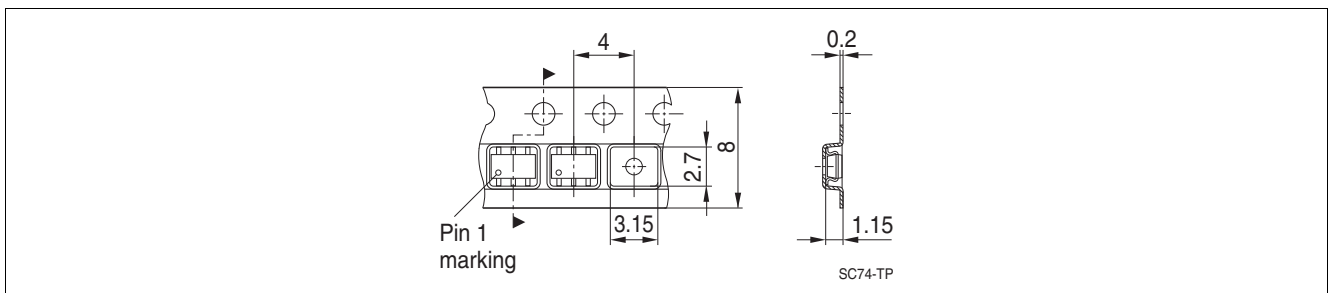

Figure 11 Tape Loading

[www.infineon.com](http://www.infineon.com)

Published by Infineon Technologies AG